

## Price List

Effective May 2023

\*\*Quick ship temporarily unavailable for some items.\*\*



PROUDLY MADE IN THE U.S.A.

Quality Built Since 1962

**Tennsco, LLC is a family-owned company located in Dickson, TN. Founded in 1962, Tennsco is an industry leader in steel storage solutions. Tennsco is proud to manufacture its products in the USA.**

## Environmentally Friendly Products

Certified SCS Indoor Advantage Gold for indoor air quality and low VOC emissions.

Tennsco products allow our customers to apply LEED credits as described below:

- MR Credit 4.1 and 4.2 - Recycled Content
- MR Credit 5.1 - Manufactured Regionally
- MR Credit 5.2 - Extracted and Manufactured Regionally
- EQ Credit 4.2 - Low Emitting Materials, Paints



## Available Colors

Tennsco products have a tough, long lasting powder coated or electrocoated paint finish. Available standard colors vary by product line. All standard color options are listed at the bottom portion of each page, unless otherwise specified.

Standard Colors are available at no additional charge. Premium and Special Matched Colors are available for an upcharge. Finishes shown are representative of the actual finishes. Please contact your local Tennsco dealer for more precise color swatches.



Items with one of these symbols are part of Tennsco's quick ship program and ship within 2-3 days. Quick ship is subject to maximum order quantities.

| Quickship Legend |                                       |
|------------------|---------------------------------------|
| ◆                | - All 5 Standard Colors               |
| ♠                | - Sand, Medium Grey & Black           |
| ♥                | - Champaign Putty, Light Grey & Black |
| ♣                | - Medium Grey                         |
| ●                | - Black                               |
| ■                | - Sand                                |
| ▲                | - Sand & Medium Grey                  |
| S                | - Black & Light Grey                  |
| ▶                | - Sand & Light Grey                   |
| Ω                | - Light Grey                          |
| ◻                | <b>Unfinished</b>                     |
| ▼                | Zinc Plated                           |



# Table of Contents

## COMMERCIAL

|   |                       |
|---|-----------------------|
| <a href="#">Storage Cabinets</a>  | <a href="#">4-10</a>  |
| <a href="#">Bookcases</a>   | <a href="#">11</a>    |
| <a href="#">Lateral Files</a>   | <a href="#">12-13</a> |
| <a href="#">Card &amp; Multimedia, Literature Sorters, 30 Drawer Organizers &amp; Fixed Shelf Lateral Files</a> | <a href="#">14</a>    |
| <a href="#">Imperial Shelving &amp; Doors</a>   | <a href="#">15</a>    |
| <a href="#">Regal, Capstone &amp; Commercial Clip Shelving</a>  | <a href="#">16</a>    |

## INDUSTRIAL

|   |                       |
|---|-----------------------|
| <a href="#">Lockers</a>                         | <a href="#">17-33</a> |
| <a href="#">Z-Line Boltless Shelving</a>        | <a href="#">34-43</a> |
| <a href="#">Bulk Storage</a>                    | <a href="#">44-48</a> |
| <a href="#">Q-Line Industrial Clip Shelving</a> | <a href="#">49-55</a> |
| <a href="#">L&amp;T Shelving</a>                | <a href="#">56-65</a> |
| <a href="#">Workbenches</a>                     | <a href="#">66-75</a> |
| <a href="#">Packing Tables</a>                  | <a href="#">76</a>    |

**Product dimensions listed throughout are nominal, actual dimensions may vary. For detailed specifications, contact Tennsco. Freight Classifications listed throughout this price list are subject to change.**

### POLICY AND SERVICES

**PRICING:** All prices are F.O.B. Tennsco, LLC's Facility in Dickson, Tennessee. All orders are subject to final acceptance at the Home Office, Dickson, Tennessee. Prices subject to change without notice. Tennsco has the right to make product design changes at any time. Tennsco's prices do not include sales, use, excise or similar taxes. Consequently, in addition to the prices specified herein, the amount of any present or future sales, use, excise or similar tax applicable to the manufacture, sale, purchase or use of the goods sold hereunder shall be paid by Buyer. In lieu thereof, Buyer shall provide Tennsco with a tax exemption certificate acceptable to the applicable taxing authorities.

**TERMS OF PAYMENT:** Terms are Net 30 Days from date of shipment. A service charge of 1 1/2% per month will be charged for overdue invoices.

**MINIMUM ORDERS:** Minimum order is \$15.00.

**SPECIFICATIONS:** Tennsco reserves the right to change any product specifications contained in this price list.

**FREIGHT CHARGES:** All shipments will be made freight collect unless otherwise specified. If freight is paid by Tennsco, it will be added to the invoice or billed separately, depending on arrangements. On shipments by parcel post, the postage will be added to the invoice. All routing will be done solely by the Home Office. If purchaser does not accept delivery of merchandise when ready for shipment, storage fees will be charged to the purchaser.

**WEIGHT:** Shipping weights shown are approximate.

**FREIGHT CLAIMS:** Claims for shortages must be made in writing to the Home Office within 5 business days from receipt of shipment. Claims for damaged or lost material must be filed with the carrier.

**CAUTION:** When you give delivering carrier a clear receipt for a shipment in which there is damaged merchandise or a shortage, the carrier is relieved of further responsibility. Claims for damage or shortage must be filed by you with the delivering carrier. Tennsco will not accept return of merchandise damaged in transit. Your claim is with the delivering carrier.

**CANCELLATIONS & RETURNS:** No return merchandise will be accepted or approved, based on product, color and quantity, without written consent of the Tennsco General Office, Dickson, Tennessee. If return is approved, all returned shipments are subject to a handling charge of 25% plus all transportation charges incurred by Tennsco unless Tennsco is at fault. Orders for "Special" items are not subject to change, cancellation or return. Once production of "Special" items has begun, cancellation of order is subject to Tennsco approval. A 15% surcharge will be assessed to approved cancelled items.

### LIMITED WARRANTY

Tennsco warrants goods purchased hereunder to be free of defects in materials and workmanship for a period of one (1) year from the date of shipment, hereunder. Tennsco's warranty shall not apply in the event goods are damaged as a result of misuse, abuse, neglect, accident, improper application, modification or repair by persons not authorized by Tennsco, where goods are damaged during shipment. UNLESS CONSIDERED UNENFORCEABLE OR UNLAWFUL UNDER APPLICABLE LAW:

- a. ALL IMPLIED WARRANTIES, INCLUDING BUT NOT LIMITED TO WARRANTIES OR MERCHANTABILITY AND FITNESS FOR A PARTICULAR PURPOSE ARE HEREBY EXCLUDED.
- b. BUYERS REMEDY, IF ANY, FOR ANY DEFECTIVE GOODS SHALL BE LIMITED TO A REFUND BY TENNSCO OR REPLACEMENT OF THE GOODS AT TENNSCO'S OPTION AND SHALL IN NO EVENT INCLUDE DAMAGES OF ANY KIND, WHETHER INCIDENTAL, CONSEQUENTIAL OR OTHERWISE.

NO GOODS ACCEPTED FOR RETURN WITHOUT PRIOR APPROVAL. Tennsco shall have the right to inspect any goods claimed to be defective at Buyer's place of business or require Buyer to return the goods to Tennsco for inspection on Tennsco's premises. Transportation charges covering returned goods will be borne by Tennsco only if such goods are proven to be defective, are covered by this warranty and are returned within the warranty period stated above.

# Jumbo Cabinets

## JUMBO TRADITIONAL CABINETS



J1878SU  
Solid Doors



CVDJ2478SU  
Clear View Doors



JSD1878SU  
Sliding Doors

| W  | D      | H  | Shelf Load Cap.* | # of Openings | WELDED     |       |            | UNASSEMBLED |       |            |
|--|--------|----|------------------|---------------|------------|-------|------------|-------------|-------|------------|
|  |        |    |                  |               | CAT. NO.   | WT.   | PRICE      | CAT. NO.    | WT.   | PRICE      |
| <b>SOLID DOORS</b>   |        |    |                  |               |            |       |            |             |       |            |
| 48   | 18     | 30 | 400              | 2             | J1830SU    | 103.0 | \$897.00   | -           | -     | -          |
| 48   | 18     | 42 | 400              | 2             | J1842SU    | 121.0 | 954.00     | J1842A      | 113.0 | \$798.00   |
| 48   | 24     | 42 | 400              | 2             | J2442SU    | 135.0 | 1,002.00   | J2442A      | 121.0 | 814.00     |
| 48   | 18     | 78 | 400              | 5             | J1878SU    | 203.0 | 1,366.00   | J1878A-N    | 180.0 | 1,103.00   |
| 48   | 24     | 78 | 400              | 5             | J2478SU    | 233.0 | 1,485.00   | J2478A-N    | 208.0 | 1,185.00   |
| <b>C-THRU DOORS (Electronic Lock Not Available)</b>              |        |    |                  |               |            |       |            |             |       |            |
| 48   | 18     | 42 | 400              | 2             | CVDJ1842SU | 121.0 | \$1,074.00 | -           | -     | -          |
| 48   | 18     | 78 | 400              | 5             | CVDJ1878SU | 207.0 | 1,546.00   | CVDJ1878A-N | 187.0 | \$1,283.00 |
| 48   | 24     | 78 | 400              | 5             | CVDJ2478SU | 230.0 | 1,665.00   | CVDJ2478A-N | 215.0 | 1,365.00   |
| <b>SLIDING DOORS (Optional Locks/Padlock Hasp Not Available)</b> |        |    |                  |               |            |       |            |             |       |            |
| 48   | 21 1/4 | 78 | 400              | 5             | JSD1878SU  | 228.0 | \$1,842.00 | -           | -     | -          |
| 48   | 27 1/4 | 78 | 400              | 5             | JSD2478SU  | 258.0 | 1,960.00   | -           | -     | -          |

| Accessories          |    |    |         |           |          |      |          |
|----------------------|----|----|---------|-----------|----------|------|----------|
| Description          | W  | D  | H       | Load Cap. | CAT. NO. | WT.  | PRICE    |
| <b>EXTRA SHELVES</b> |    |    |         |           |          |      |          |
| Full Width Shelf     | 48 | 18 | 1 5/16  | 400       | 306      | 10.6 | \$69.00  |
| Full Width Shelf     | 48 | 24 | 1 5/16  | 400       | 307      | 14.0 | 77.00    |
| <b>CASTER KITS</b>   |    |    |         |           |          |      |          |
| Fits 48"W x 24"D     | 48 | 24 | 6 11/16 | 1,000     | CK-4824  | 24.0 | \$213.00 |

\*Load Capacities are lbs. per shelf, evenly distributed.

For optional security lock (\$60 List), add suffix "HL" to catalog number.  
 For optional electronic lock (\$160 List), add suffix "EL" to catalog number. Only available on select welded units.  
 For optional keyed alike lock (\$25 List), add suffix "KA" to catalog number.  
 For optional padlock hasp (\$26 List), add suffix "-HSP" to catalog number for welded units. Padlock hasp must be ordered separately under HSP for KD units. Padlock hasp can only be used with solid, double handled doors.

National Motor Freight Class: Welded 175, Unassembled 85

## JUMBO WARDROBE CABINETS



J1878SUW  
Solid Doors

| W                  | D  | H  | Shelf Load Cap.* | # of Openings | WELDED   |       |            | UNASSEMBLED |       |          |
|--------------------|----|----|------------------|---------------|----------|-------|------------|-------------|-------|----------|
|                    |    |    |                  |               | CAT. NO. | WT.   | PRICE      | CAT. NO.    | WT.   | PRICE    |
| <b>SOLID DOORS</b> |    |    |                  |               |          |       |            |             |       |          |
| 48                 | 18 | 78 | 400              | 2             | J1878SUW | 191.0 | \$1,235.00 | J1878A-N-W  | 173.0 | \$999.00 |
| 48                 | 24 | 78 | 400              | 2             | J2478SUW | 212.0 | 1,340.00   | J2478A-N-W  | 199.0 | 1,058.00 |

| Accessories          |    |    |         |           |          |      |          |
|----------------------|----|----|---------|-----------|----------|------|----------|
| Description          | W  | D  | H       | Load Cap. | CAT. NO. | WT.  | PRICE    |
| <b>EXTRA SHELVES</b> |    |    |         |           |          |      |          |
| Full Width Shelf     | 48 | 18 | 1 5/16  | 400       | 306      | 10.6 | \$69.00  |
| Full Width Shelf     | 48 | 24 | 1 5/16  | 400       | 307      | 14.0 | 77.00    |
| <b>CASTER KITS</b>   |    |    |         |           |          |      |          |
| Fits 48"W x 24"D     | 48 | 24 | 6 11/16 | 1,000     | CK-4824  | 24.0 | \$213.00 |

\*Load Capacities are lbs. per shelf, evenly distributed.

For optional security lock (\$60 List), add suffix "HL" to catalog number.  
 For optional electronic lock (\$160 List), add suffix "EL" to catalog number. Only available on select welded units.  
 For optional keyed alike lock (\$25 List), add suffix "KA" to catalog number.  
 For optional padlock hasp (\$26 List), add suffix "-HSP" to catalog number for welded units. Padlock hasp must be ordered separately under HSP for KD units. Padlock hasp can only be used with solid, double handled doors.



CK-4824  
Caster Kit

National Motor Freight Class: Welded 175, Unassembled 85

### Standard Colors



Items with these symbols are available to ship in 2-3 days. Limited quantities and select colors.

|       |       |       |       |       |
|-------|-------|-------|-------|-------|
| ◆     | ◆     | ◆     | ◆     | ◆     |
| (SND) | (CPY) | (LGY) | (MGY) | (BLK) |
| ◆     | ◆     | ◆     | ◆     | ◆     |
| (SND) | (MGY) | (BLK) |       |       |

# Jumbo and Deluxe Cabinets

## JUMBO COMBINATION CABINETS

| W                  | D  | H  | SHELF CAPACITY* |            | # of Openings | WELDED            |       |            | UNASSEMBLED     |       |            |
|--------------------|----|----|-----------------|------------|---------------|-------------------|-------|------------|-----------------|-------|------------|
|                    |    |    | Full Width      | Half Width |               | CAT. NO.          | WT.   | PRICE      | CAT. NO.        | WT.   | PRICE      |
| <b>SOLID DOORS</b> |    |    |                 |            |               |                   |       |            |                 |       |            |
| 48                 | 18 | 78 | 400             | 75         | 7             | <b>J1878SUC</b>   | 203.0 | \$1,427.00 | <b>J1878C-N</b> | 193.0 | \$1,183.00 |
| 48                 | 24 | 78 | 400             | 75         | 7             | <b>J2478SUC</b> ♦ | 230.0 | 1,559.00   | <b>J2478C-N</b> | 213.0 | 1,271.00   |

| Accessories          |    |    |         |           |                  |      |          |
|----------------------|----|----|---------|-----------|------------------|------|----------|
| Description          | W  | D  | H       | Load Cap. | CAT. NO.         | WT.  | PRICE    |
| <b>EXTRA SHELVES</b> |    |    |         |           |                  |      |          |
| Full Width Shelf     | 48 | 18 | 1 5/16  | 400       | <b>306</b> ♦     | 10.6 | \$69.00  |
| Full Width Shelf     | 48 | 24 | 1 5/16  | 400       | <b>307</b> ♦     | 14.0 | 77.00    |
| Half Width Shelf     | 24 | 16 | 3/4     | 75        | <b>JPS18</b>     | 3.9  | 48.00    |
| Half Width Shelf     | 24 | 22 | 3/4     | 75        | <b>JPS24</b>     | 5.2  | 51.00    |
| <b>CASTER KITS</b>   |    |    |         |           |                  |      |          |
| Fits 48"W x 24"D     | 48 | 24 | 6 11/16 | 1,000     | <b>CK-4824</b> ♦ | 24.0 | \$213.00 |

\*Load Capacities are lbs. per shelf, evenly distributed.

For optional security lock (\$60 List), add suffix "HL" to catalog number.  
 For optional electronic lock (\$160 List), add suffix "EL" to catalog number. Only available on select welded units.  
 For optional keyed alike lock (\$25 List), add suffix "KA" to catalog number.  
 For optional padlock hasp (\$26 List), add suffix "-HSP" to catalog number for welded units. Padlock hasp must be ordered separately under HSP for KD units. Padlock hasp can only be used with solid, double handled doors.



J1878SUC  
Solid Doors

National Motor Freight Class: Welded 175, Unassembled 85

## DELUXE TRADITIONAL CABINETS

| W   | D  | H  | Shelf Load Cap.* | # of Openings | WELDED           |       |            | UNASSEMBLED    |       |          |
|---|----|----|------------------|---------------|------------------|-------|------------|----------------|-------|----------|
|   |    |    |                  |               | CAT. NO.         | WT.   | PRICE      | CAT. NO.       | WT.   | PRICE    |
| <b>SOLID DOORS</b>  |    |    |                  |               |                  |       |            |                |       |          |
| 36  | 18 | 42 | 200              | 3             | <b>4218DLX</b> • | 90.0  | \$805.00   | <b>1842</b> ♦  | 90.0  | \$638.00 |
| 36  | 24 | 42 | 200              | 3             | <b>4224DLX</b> • | 103.0 | 894.00     | <b>2442</b> ♦  | 103.0 | 704.00   |
| 36  | 18 | 72 | 200              | 5             | <b>7218DLX</b> ♦ | 145.0 | 1,010.00   | -              | -     | -        |
| 36  | 18 | 78 | 200              | 5             | <b>7818</b> ♦    | 157.0 | 1,042.00   | <b>1870</b> ♦  | 154.0 | 909.00   |
| 36  | 24 | 78 | 200              | 5             | <b>7824</b> ♦    | 178.0 | 1,159.00   | <b>2470</b> ♦  | 168.0 | 999.00   |
| <b>SOLID DOORS WITH RECESSED HANDLES (Padlock Hasp Not Available)</b> |    |    |                  |               |                  |       |            |                |       |          |
| 36  | 18 | 78 | 200              | 5             | <b>7818RH</b>    | 157.0 | \$1,052.00 | <b>1870RH</b>  | 154.0 | \$919.00 |
| 36  | 24 | 78 | 200              | 5             | <b>7824RH</b>    | 175.0 | 1,169.00   | <b>2470RH</b>  | 168.0 | 1,009.00 |
| <b>C-THRU DOORS (Electronic Lock Not Available)</b>                   |    |    |                  |               |                  |       |            |                |       |          |
| 36  | 18 | 42 | 200              | 3             | -                | -     | -          | <b>CVD1842</b> | 90.0  | \$758.00 |
| 36  | 24 | 42 | 200              | 3             | -                | -     | -          | <b>CVD2442</b> | 103.0 | 824.00   |
| 36  | 18 | 78 | 200              | 5             | <b>CVD7818</b>   | 162.0 | \$1,192.00 | <b>CVD1870</b> | 154.0 | 1,059.00 |
| 36  | 24 | 78 | 200              | 5             | <b>CVD7824</b>   | 194.0 | 1,309.00   | <b>CVD2470</b> | 183.0 | 1,149.00 |

| Accessories          |    |    |         |           |               |      |          |
|----------------------|----|----|---------|-----------|---------------|------|----------|
| Description          | W  | D  | H       | Load Cap. | CAT. NO.      | WT.  | PRICE    |
| <b>EXTRA SHELVES</b> |    |    |         |           |               |      |          |
| Full Width Shelf     | 36 | 18 | 1 1/8   | 200       | <b>301</b> ♦  | 8.2  | \$43.00  |
| Full Width Shelf     | 36 | 24 | 1 1/8   | 200       | <b>302</b> ♦  | 10.5 | 58.00    |
| <b>CASTER KITS</b>   |    |    |         |           |               |      |          |
| Fits 36"W x 18"D     | 36 | 18 | 6 11/16 | 1,000     | <b>CK18</b> ♦ | 21.0 | \$175.00 |
| Fits 36"W x 24"D     | 36 | 24 | 6 11/16 | 1,000     | <b>CK24</b> ♦ | 23.0 | 184.00   |

\*Load Capacities are lbs. per shelf, evenly distributed.

For optional security lock (\$60 List), add suffix "HL" to catalog number.  
 For optional electronic lock (\$160 List), add suffix "EL" to catalog number. Only available on select welded units.  
 For optional keyed alike lock (\$25 List), add suffix "KA" to catalog number.  
 For optional padlock hasp (\$26 List), add suffix "-HSP" to catalog number for welded units. Padlock hasp must be ordered separately under HSP for KD units. Padlock hasp can only be used with solid, double handled doors.



7818  
Solid Doors



7824RH  
Solid Doors with Recessed Handles



CVD7824  
Clear View Doors

National Motor Freight Class: Welded 175, Unassembled 85

### Standard Colors



♦ •  
 Items with these symbols are available to ship in 2-3 days. Limited quantities and select colors.

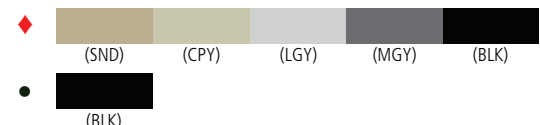

# Deluxe Cabinets

## DELUXE WARDROBE CABINETS



7818W  
Solid Doors

| W   | D  | H  | Shelf Load Cap.* | # of Openings | WELDED   |       |            | UNASSEMBLED |       |          |
|---|----|----|------------------|---------------|----------|-------|------------|-------------|-------|----------|
|   |    |    |                  |               | CAT. NO. | WT.   | PRICE      | CAT. NO.    | WT.   | PRICE    |
| <b>SOLID DOORS</b>                                  |    |    |                  |               |          |       |            |             |       |          |
| 36  | 18 | 78 | 200              | 2             | 7818W ♣  | 134.0 | \$958.00   | 1871 ♣      | 140.0 | \$810.00 |
| 36  | 24 | 78 | 200              | 2             | 7824W ♣  | 154.0 | 1,041.00   | 2471 ♣      | 155.0 | 965.00   |
| <b>C-THRU DOORS (Electronic Lock Not Available)</b> |    |    |                  |               |          |       |            |             |       |          |
| 36  | 18 | 78 | 200              | 2             | CVD7818W | 140.0 | \$1,108.00 | CVD1871     | 140.0 | \$960.00 |
| 36  | 24 | 78 | 200              | 2             | CVD7824W | 164.0 | 1,191.00   | CVD2471     | 155.0 | 1,115.00 |



| Accessories          |    |    |         |           |          |      |          |
|----------------------|----|----|---------|-----------|----------|------|----------|
| Description          | W  | D  | H       | Load Cap. | CAT. NO. | WT.  | PRICE    |
| <b>EXTRA SHELVES</b> |    |    |         |           |          |      |          |
| Full Width Shelf     | 36 | 18 | 1 1/8   | 200       | 301♦     | 8.2  | \$43.00  |
| Full Width Shelf     | 36 | 24 | 1 1/8   | 200       | 302♦     | 10.5 | 58.00    |
| <b>CASTER KITS</b>   |    |    |         |           |          |      |          |
| Fits 36"W x 18"D     | 36 | 18 | 6 11/16 | 1,000     | CK18♦    | 21.0 | \$175.00 |
| Fits 36"W x 24"D     | 36 | 24 | 6 11/16 | 1,000     | CK24♦    | 23.0 | 184.00   |

\*Load Capacities are lbs. per shelf, evenly distributed.

For optional security lock (\$60 List), add suffix "HL" to catalog number.

For optional electronic lock (\$160 List), add suffix "EL" to catalog number. Only available on select welded units.

For optional keyed alike lock (\$25 List), add suffix "KA" to catalog number.

For optional padlock hasp (\$26 List), add suffix "-HSP" to catalog number for welded units. Padlock hasp must be ordered separately under HSP for KD units. Padlock hasp can only be used with solid, double handled doors.

National Motor Freight Class: Welded 175, Unassembled 85

## DELUXE COMBINATION CABINETS



7814  
Solid Doors

| W   | D  | H  | SHELF CAPACITY* |            | # of Openings | WELDED   |       |            | UNASSEMBLED |       |            |
|---|----|----|-----------------|------------|---------------|----------|-------|------------|-------------|-------|------------|
|   |    |    | Full Width      | Half Width |               | Cat. No. | Wt.   | Price      | CAT. NO.    | WT.   | PRICE      |
| <b>SOLID DOORS</b>                                  |    |    |                 |            |               |          |       |            |             |       |            |
| 36  | 18 | 78 | 200             | 75         | 7             | 7814     | 156.0 | \$1,112.00 | 1872        | 152.0 | \$960.00   |
| 36  | 24 | 78 | 200             | 75         | 7             | 7820     | 178.0 | 1,219.00   | 2472        | 181.0 | 1,038.00   |
| <b>C-THRU DOORS (Electronic Lock Not Available)</b> |    |    |                 |            |               |          |       |            |             |       |            |
| 36  | 18 | 78 | 200             | 75         | 7             | CVD7814  | 160.0 | \$1,262.00 | CVD1872     | 152.0 | \$1,110.00 |
| 36  | 24 | 78 | 200             | 75         | 7             | CVD7820  | 192.0 | 1,369.00   | CVD2472     | 181.0 | 1,188.00   |

| Accessories          |    |    |         |           |          |      |          |
|----------------------|----|----|---------|-----------|----------|------|----------|
| Description          | W  | D  | H       | Load Cap. | CAT. NO. | WT.  | PRICE    |
| <b>EXTRA SHELVES</b> |    |    |         |           |          |      |          |
| Full Width Shelf     | 36 | 18 | 1 1/8   | 200       | 301♦     | 8.2  | \$43.00  |
| Full Width Shelf     | 36 | 24 | 1 1/8   | 200       | 302♦     | 10.5 | 58.00    |
| Half Width Shelf     | 19 | 16 | 3/4     | 75        | 304♦     | 4.0  | 27.00    |
| Half Width Shelf     | 19 | 22 | 3/4     | 75        | 305♦     | 5.8  | 33.00    |
| <b>CASTER KITS</b>   |    |    |         |           |          |      |          |
| Fits 36"W x 18"D     | 36 | 18 | 6 11/16 | 1,000     | CK18♦    | 21.0 | \$175.00 |
| Fits 36"W x 24"D     | 36 | 24 | 6 11/16 | 1,000     | CK24♦    | 23.0 | 184.00   |

\*Load Capacities are lbs. per shelf, evenly distributed.

For optional security lock (\$60 List), add suffix "HL" to catalog number.

For optional electronic lock (\$160 List), add suffix "EL" to catalog number. Only available on select welded units.

For optional keyed alike lock (\$25 List), add suffix "KA" to catalog number.

For optional padlock hasp (\$26 List), add suffix "-HSP" to catalog number for welded units. Padlock hasp must be ordered separately under HSP for KD units. Padlock hasp can only be used with solid, double handled doors.

National Motor Freight Class: Welded 175, Unassembled 85

### Standard Colors



♦ ♣  
Items with these symbols are available to ship in 2-3 days. Limited quantities and select colors.

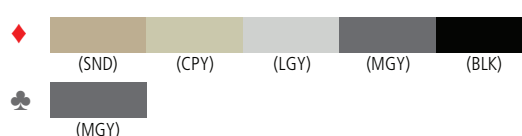

# Standard Cabinets

## STANDARD TRADITIONAL CABINETS

| W   | D  | H  | Shelf Load Cap.* | # of Openings | WELDED   |       |          | UNASSEMBLED |       |          |
|---|----|----|------------------|---------------|----------|-------|----------|-------------|-------|----------|
|   |    |    |                  |               | CAT. NO. | WT.   | PRICE    | CAT. NO.    | WT.   | PRICE    |
| <b>SOLID DOORS</b>  |    |    |                  |               |          |       |          |             |       |          |
| 36  | 18 | 30 | 200              | 2             | 3018♦    | 58.0  | \$530.00 | 1430♦       | 51.0  | \$421.00 |
| 36  | 18 | 36 | 200              | 2             | 3618     | 70.5  | 580.00   | 1436        | 68.0  | 494.00   |
| 36  | 24 | 36 | 200              | 2             | 3624     | 72.0  | 660.00   | 2436        | 78.0  | 538.00   |
| 36  | 18 | 42 | 200              | 3             | 4218♦    | 79.0  | 606.00   | 1442♦       | 74.0  | 508.00   |
| 36  | 24 | 42 | 200              | 3             | 4224     | 88.0  | 679.00   | 1420        | 85.0  | 607.00   |
| 36  | 18 | 60 | 200              | 5             | 6018DH♣  | 107.0 | 813.00   | -           | -     | -        |
| 36  | 24 | 60 | 200              | 5             | 6024DH♣  | 126.0 | 893.00   | -           | -     | -        |
| 30  | 15 | 66 | 150              | 5             | 6615•    | 126.0 | 914.00   | -           | -     | -        |
| 36  | 18 | 66 | 200              | 5             | 6618DH♣  | 120.0 | 863.00   | -           | -     | -        |
| 36  | 24 | 66 | 200              | 5             | 6624DH♣  | 136.0 | 976.00   | -           | -     | -        |
| 30  | 15 | 72 | 150              | 5             | 7215     | 116.0 | 737.00   | -           | -     | -        |
| 30  | 18 | 72 | 150              | 5             | 721830   | 123.5 | 785.00   | 3070        | 121.5 | 729.00   |
| 36  | 18 | 72 | 200              | 5             | 7218♦    | 126.0 | 813.00   | 1470♦       | 122.0 | 738.00   |
| 36  | 24 | 72 | 200              | 5             | 7224♦    | 143.0 | 927.00   | 1480♦       | 139.0 | 842.00   |
| <b>SOLID DOORS WITH RECESSED HANDLES (Padlock Hasp Not Available)</b> |    |    |                  |               |          |       |          |             |       |          |
| 36  | 18 | 72 | 200              | 5             | 7218RH   | 126.0 | \$833.00 | 1470RH      | 122.0 | \$758.00 |
| 36  | 24 | 72 | 200              | 5             | 7224RH   | 143.0 | 947.00   | 1480RH      | 139.0 | 862.00   |
| <b>C-THRU DOORS (Electronic Lock Not Available)</b>                   |    |    |                  |               |          |       |          |             |       |          |
| 36  | 18 | 42 | 200              | 3             | CVD4218♣ | 82.0  | \$726.00 | CVD1442     | 69.0  | \$628.00 |
| 36  | 24 | 42 | 200              | 3             | CVD4224  | 97.0  | 799.00   | CVD1420     | 84.0  | 727.00   |
| 36  | 18 | 72 | 200              | 5             | CVD7218♣ | 136.0 | 943.00   | CVD1470     | 113.0 | 868.00   |
| 36  | 24 | 72 | 200              | 5             | CVD7224♣ | 153.0 | 1,057.00 | CVD1480     | 136.0 | 972.00   |



7218  
Solid Doors



7218RH  
Solid Doors with  
Recessed Handles



CVD4218  
Clear View Doors

| Accessories          |    |    |         |           |          |      |          |
|----------------------|----|----|---------|-----------|----------|------|----------|
| Description          | W  | D  | H       | Load Cap. | CAT. NO. | WT.  | PRICE    |
| <b>EXTRA SHELVES</b> |    |    |         |           |          |      |          |
| Full Width Shelf     | 30 | 15 | 1 1/8   | 150       | 315      | 6.1  | \$32.00  |
| Full Width Shelf     | 30 | 18 | 1 1/8   | 150       | 318      | 6.8  | 39.00    |
| Full Width Shelf     | 36 | 18 | 1 1/8   | 200       | 301♦     | 8.2  | 43.00    |
| Full Width Shelf     | 36 | 24 | 1 1/8   | 200       | 302♦     | 10.5 | 58.00    |
| <b>CASTER KITS</b>   |    |    |         |           |          |      |          |
| Fits 36"W x 18"D     | 36 | 18 | 6 11/16 | 1,000     | CK18♦    | 21.0 | \$175.00 |
| Fits 36"W x 24"D     | 36 | 24 | 6 11/16 | 1,000     | CK24♦    | 23.0 | 184.00   |

\*Load Capacities are lbs. per shelf, evenly distributed.

For optional security lock (\$60 List), add suffix "HL" to catalog number.

For optional electronic lock (\$160 List), add suffix "EL" to catalog number. Only available on select welded units.

For optional keyed alike lock (\$25 List), add suffix "KA" to catalog number.

National Motor Freight Class: Welded 175, Unassembled 85

## STANDARD WARDROBE CABINETS

| W   | D  | H  | Shelf Load Cap.* | # of Openings | WELDED   |       |          | UNASSEMBLED |       |          |
|---|----|----|------------------|---------------|----------|-------|----------|-------------|-------|----------|
|   |    |    |                  |               | CAT. NO. | WT.   | PRICE    | CAT. NO.    | WT.   | PRICE    |
| <b>SOLID DOORS</b>                                  |    |    |                  |               |          |       |          |             |       |          |
| 36  | 18 | 72 | 200              | 2             | 7114♣    | 107.0 | \$744.00 | 1471♣       | 100.0 | \$661.00 |
| 36  | 24 | 72 | 200              | 2             | 7124♣    | 138.0 | 834.00   | -           | -     | -        |
| <b>C-THRU DOORS (Electronic Lock Not Available)</b> |    |    |                  |               |          |       |          |             |       |          |
| 36  | 18 | 72 | 200              | 2             | CVD7114  | 111.0 | \$874.00 | CVD1471     | 99.0  | \$791.00 |



7114  
Solid Doors



CK-18  
Caster Kit

| Accessories          |    |    |         |           |          |      |          |
|----------------------|----|----|---------|-----------|----------|------|----------|
| Description          | W  | D  | H       | Load Cap. | CAT. NO. | WT.  | PRICE    |
| <b>EXTRA SHELVES</b> |    |    |         |           |          |      |          |
| Full Width Shelf     | 36 | 18 | 1 1/8   | 200       | 301♦     | 8.2  | \$43.00  |
| Full Width Shelf     | 36 | 24 | 1 1/8   | 200       | 302♦     | 10.5 | 58.00    |
| <b>CASTER KITS</b>   |    |    |         |           |          |      |          |
| Fits 36"W x 18"D     | 36 | 18 | 6 11/16 | 1,000     | CK18♦    | 21.0 | \$175.00 |
| Fits 36"W x 24"D     | 36 | 24 | 6 11/16 | 1,000     | CK24♦    | 23.0 | 184.00   |

\*Load Capacities are lbs. per shelf, evenly distributed.

For optional security lock (\$60 List), add suffix "HL" to catalog number.

For optional electronic lock (\$160 List), add suffix "EL" to catalog number. Only available on select welded units.

For optional keyed alike lock (\$25 List), add suffix "KA" to catalog number.

National Motor Freight Class: Welded 175, Unassembled 85

### Standard Colors



♦ ♣  
Items with these symbols are available to ship in 2-3 days. Limited quantities and select colors.

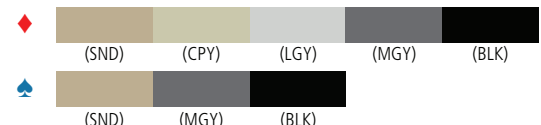

# Standard & Specialty Cabinets

## STANDARD COMBINATION CABINETS

| W   | D  | H  | SHELF CAPACITY* |            | # of Openings | WELDED   |       |            | UNASSEMBLED |       |          |
|---|----|----|-----------------|------------|---------------|----------|-------|------------|-------------|-------|----------|
|   |    |    | Full Width      | Half Width |               | CAT. NO. | WT.   | PRICE      | CAT. NO.    | WT.   | PRICE    |
| <b>SOLID DOORS</b>                                  |    |    |                 |            |               |          |       |            |             |       |          |
| 36  | 24 | 66 | 200             | 75         | 7             | 6620DH   | 135.0 | \$1,010.00 | -           | -     | -        |
| 36  | 18 | 72 | 200             | 75         | 7             | 7214♦    | 125.0 | 861.00     | 1472♦       | 123.0 | \$774.00 |
| 36  | 24 | 72 | 200             | 75         | 7             | 7220♦    | 143.0 | 1,013.00   | 1482♣       | 149.0 | 865.00   |
| <b>C-THRU DOORS (Electronic Lock Not Available)</b> |    |    |                 |            |               |          |       |            |             |       |          |
| 36  | 18 | 72 | 200             | 75         | 7             | CVD7214  | 132.0 | \$991.00   | CVD1472     | 112.0 | \$904.00 |
| 36  | 24 | 72 | 200             | 75         | 7             | CVD7220  | 155.0 | 1,143.00   | -           | -     | -        |

 7220  
 Solid Doors

| Accessories          |    |    |         |           |          |      |          |
|----------------------|----|----|---------|-----------|----------|------|----------|
| Description          | W  | D  | H       | Load Cap. | CAT. NO. | WT.  | PRICE    |
| <b>EXTRA SHELVES</b> |    |    |         |           |          |      |          |
| Full Width Shelf     | 36 | 18 | 1 1/8   | 200       | 301♦     | 8.2  | \$43.00  |
| Full Width Shelf     | 36 | 24 | 1 1/8   | 200       | 302♦     | 10.5 | 58.00    |
| Half Width Shelf     | 19 | 16 | 3/4     | 75        | 304♦     | 4.0  | 27.00    |
| Half Width Shelf     | 19 | 22 | 3/4     | 75        | 305♦     | 5.8  | 33.00    |
| <b>CASTER KITS</b>   |    |    |         |           |          |      |          |
| Fits 36"W x 18"D     | 36 | 18 | 6 11/16 | 1,000     | CK18♦    | 21.0 | \$175.00 |
| Fits 36"W x 24"D     | 36 | 24 | 6 11/16 | 1,000     | CK24♦    | 23.0 | 184.00   |

\*Load Capacities are lbs. per shelf, evenly distributed.

For optional security lock (\$60 List), add suffix "HL" to catalog number.

For optional electronic lock (\$160 List), add suffix "EL" to catalog number. Only available on select welded units.

For optional keyed alike lock (\$25 List), add suffix "KA" to catalog number.

National Motor Freight Class: Welded 175, Unassembled 85

## CANTILEVERED BIN STORAGE CABINETS



| W  | D  | H  | Bin Rails Included | WELDED   |       |            |
|----|----|----|--------------------|----------|-------|------------|
|    |    |    |                    | CAT. NO. | WT.   | PRICE      |
| 36 | 18 | 78 | 8                  | 7818BC   | 216.0 | \$1,613.00 |
| 36 | 24 | 78 | 8                  | 7824BC   | 240.0 | 1,628.00   |

| Accessories          |    |     |       |           |          |     |         |
|----------------------|----|-----|-------|-----------|----------|-----|---------|
| Description          | W  | D   | H     | Load Cap. | CAT. NO. | WT. | PRICE   |
| Additional Bin Rails | 36 | 3/4 | 1 1/2 |           | CBR-36   | 2.0 | \$24.00 |

Storage bins are not included and are not sold by Tennsco.

Bins may be up to 15" deep in 18"d cabinets, and up to 18" deep in 24"d cabinets.

Bin loaded weights must not exceed 30 lbs per rail.

National Motor Freight Class: 175

## SINGLE DOOR CABINET



| W                          | D  | H   | Load Cap.* | # of Openings | WELDED   |      |          |
|----------------------------|----|-----|------------|---------------|----------|------|----------|
|                            |    |     |            |               | CAT. NO. | WT.  | PRICE    |
| <b>Single Door Cabinet</b> |    |     |            |               |          |      |          |
| 19                         | 24 | 30  | 75         | 2             | 1824♣    | 53.0 | \$545.00 |
| <b>Extra Shelf</b>         |    |     |            |               |          |      |          |
| 19                         | 24 | 3/4 | 75         | -             | 309      | 5.9  | \$47.00  |

\*Load Capacities are lbs. per shelf, evenly distributed.

National Motor Freight Class: 175

### Standard Colors



♦ ♣ ♠  
 Items with this symbol are available to ship in 2-3 days. Limited quantities and select colors.

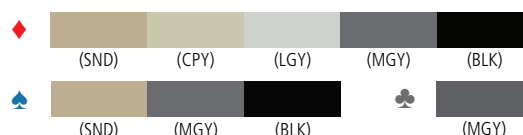



# Specialty Cabinets

## MOBILE TRADITIONAL CABINETS

|    |    |        |            |               |          |       | WELDED   |  |
|----|----|--------|------------|---------------|----------|-------|----------|--|
| W  | D  | H      | Load Cap.* | # of Openings | CAT. NO. | WT.   | PRICE    |  |
| 36 | 18 | 36 3/4 | 200        | 2             | CK3018   | 79.0  | \$643.00 |  |
| 36 | 24 | 36 3/4 | 200        | 2             | CK3024   | 85.0  | 728.00   |  |
| 36 | 18 | 78 3/4 | 200        | 5             | CK7218   | 141.0 | 926.00   |  |
| 36 | 24 | 78 3/4 | 200        | 5             | CK7224   | 158.0 | 1,045.00 |  |
| 36 | 18 | 84 3/4 | 200        | 5             | CK7818   | 171.0 | 1,155.00 |  |
| 36 | 24 | 84 3/4 | 200        | 5             | CK7824   | 190.0 | 1,277.00 |  |

| Accessories          |    |    |       |            |          |      |         |
|----------------------|----|----|-------|------------|----------|------|---------|
| Description          | W  | D  | H     | Load Cap.* | CAT. NO. | WT.  | PRICE   |
| <b>EXTRA SHELVES</b> |    |    |       |            |          |      |         |
| Full Width Shelf     | 36 | 18 | 1 1/8 | 200        | 301♦     | 8.2  | \$43.00 |
| Full Width Shelf     | 36 | 24 | 1 1/8 | 200        | 302♦     | 10.5 | 58.00   |

\*Load Capacities are lbs. per shelf, evenly distributed.

National Motor Freight Class: 175



## CHARGING CABINETS

|   |        |        |         |               |               |       | WELDED     |  |
|---|--------|--------|---------|---------------|---------------|-------|------------|--|
| W   | D      | H      | Mobile? | # of Openings | CAT. NO.      | WT.   | PRICE      |  |
| <b>42" HIGH CABINET WITH 16 CHARGING STATIONS</b> |        |        |         |               |               |       |            |  |
| 36  | 24     | 42     | No      | 17            | 4224-CMP      | 97.0  | \$1,710.00 |  |
| 36  | 24     | 48 3/4 | Yes     | 17            | 4224-CMPM     | 118.0 | 1,926.00   |  |
| <b>72" HIGH CABINET WITH 30 CHARGING STATIONS</b> |        |        |         |               |               |       |            |  |
| 36  | 24     | 72     | No      | 16            | 7224-CMP      | 282.0 | \$3,099.00 |  |
| 36  | 24     | 78 3/4 | Yes     | 16            | 7224-CMPM     | 303.0 | 3,319.00   |  |
| <b>EXTRA SHELVES</b>                              |        |        |         |               |               |       |            |  |
| 35 15/16  | 19     | 11/16  | --      | --            | CMP-SHELF     | 10.5  | \$39.00    |  |
| 16 1/2  | 17 3/8 | 11/16  | --      | --            | CMP-HALFSHELF | 2.4   | \$24.00    |  |

Power outlets must only be used for charging low-amperage devices (such as laptop computers, notebooks, tablets, etc.) to prevent power overload. Maximum amp load is 15 amps per 16-outlet strip.

Welded, set-up units. 72" high units include a center pull-out reference shelf.

Mobile units include two swivel and two fixed casters.

National Motor Freight Class: 175



## CABINETS WITH PERFORATED DOORS

|  |    |    |                  |               |            |       | WELDED     |  |
|--|----|----|------------------|---------------|------------|-------|------------|--|
| W  | D  | H  | Shelf Load Cap.* | # of Openings | CAT. NO.   | WT.   | PRICE      |  |
| <b>STANDARD CABINETS WITH PERFORATED DOORS</b> |    |    |                  |               |            |       |            |  |
| 36   | 18 | 72 | 200              | 5             | 7218-PD    | 125.0 | \$833.00   |  |
| 36   | 24 | 72 | 200              | 5             | 7224-PD    | 142.0 | 947.00     |  |
| <b>JUMBO CABINETS WITH PERFORATED DOORS</b>    |    |    |                  |               |            |       |            |  |
| 48   | 18 | 78 | 400              | 5             | J1878SU-PD | 201.0 | \$1,386.00 |  |
| 48   | 24 | 78 | 400              | 5             | J2478SU-PD | 231.0 | 1,505.00   |  |

\*Load Capacities are lbs. per shelf, evenly distributed.

National Motor Freight Class: 175



### Standard Colors



♦ Items with this symbol are available to ship in 2-3 days. Limited quantities and select colors.

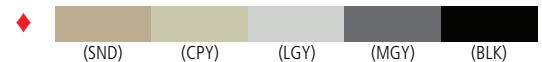

# Specialty Cabinets

## JANITORIAL CABINET



| W  | D  | H  | Shelf Load Cap.* | # of Openings | WELDED     |      |          |
|----|----|----|------------------|---------------|------------|------|----------|
|    |    |    |                  |               | CAT. NO.   | WT.  | PRICE    |
| 36 | 18 | 64 | 75               | 4             | JAN6618DH♦ | 99.0 | \$891.00 |

\*Load Capacities are lbs. per shelf, evenly distributed.

Cabinet is fully welded. Shelves do not adjust.

For optional security lock (\$60 List), add suffix "HL" to catalog number.

For optional electronic lock (\$160 List), add suffix "EL" to catalog number. Only available on select welded units.

For optional keyed alike lock (\$25 List), add suffix "KA" to catalog number.

For optional padlock hasp (\$26 List), add suffix "-HSP" to catalog number for welded units. Padlock hasp must be ordered separately under HSP for KD units. Padlock hasp can only be used with solid, double handled doors.

National Motor Freight Class: 175

## STORAGE CABINET/BOOKCASE COMBINATION



| W           | D  | H     | Shelf Load Cap.* | # of Openings | WELDED    |       |          |
|-------------|----|-------|------------------|---------------|-----------|-------|----------|
|             |    |       |                  |               | CAT. NO.  | WT.   | PRICE    |
| 36          | 18 | 72    | 200              | 5             | BCD18-72♦ | 122.0 | \$875.00 |
| EXTRA SHELF |    |       |                  |               |           |       |          |
| 36          | 18 | 1 1/8 | 200              | -             | 301♦      | 8.2   | \$43.00  |

\*Load Capacities are lbs. per shelf, evenly distributed.

National Motor Freight Class: 175

## STORAGE CABINET WITH FILE DRAWERS



| W                            | D  | H  | Shelf Load Cap.* | # of Openings | WELDED     |       |            |
|------------------------------|----|----|------------------|---------------|------------|-------|------------|
|                              |    |    |                  |               | CAT. NO.   | WT.   | PRICE      |
| WITH ONE BOTTOM FILE DRAWER  |    |    |                  |               |            |       |            |
| 36                           | 18 | 42 | 200              | 2             | DWR-4218♣  | 94.0  | \$978.00   |
| 36                           | 18 | 66 | 200              | 4             | DWR-6618♣  | 135.0 | 1,183.00   |
| WITH TWO BOTTOM FILE DRAWERS |    |    |                  |               |            |       |            |
| 36                           | 18 | 72 | 200              | 3             | DWR-7218-2 | 150.0 | \$1,713.00 |

| Accessories**     |        |        |     |          |     |         |  |
|-------------------|--------|--------|-----|----------|-----|---------|--|
| Description       | W      | D      | H   | CAT. NO. | WT. | PRICE   |  |
| Cross Rods (Pair) | 15 3/4 | 1 7/16 | 7/8 | 15CR     | 1.0 | \$13.00 |  |

\*Load Capacities are lbs. per shelf, evenly distributed.

\*\*Cross Rods (15CR) only available in Black.

Load capacities up to 120 lbs. per drawer.

All units are setup. Lateral drawers ship standard with file rods for side-to-side filing applications. For front-to-back filing, drawers will accommodate two rows of letter-sized or legal-sized files. This requires one pair of cross rods (15CR) per drawer.

Same key opens both the cabinet lock and the drawer lock.

Can not be used with caster kits.

National Motor Freight Class: 175

### Standard Colors



♦ ♣  
 Items with these symbols are available to ship in 2-3 days. Limited quantities and select colors.

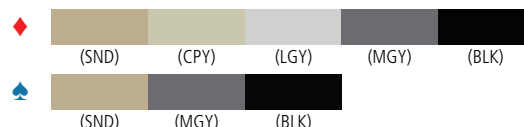

# Welded Bookcases

## WELDED BOOKCASES — 13 1/2" DEEP

| CAT. NO.                            | NO. OF OPENINGS | W      | D      | H  | WT.   | PRICE           |
|-------------------------------------|-----------------|--------|--------|----|-------|-----------------|
| <b>34 1/2" Wide Bookcases</b>       |                 |        |        |    |       |                 |
| B-30 <b>U</b>                       | 2               | 34 1/2 | 13 1/2 | 28 | 40.0  | <b>\$291.00</b> |
| B-42 <b>U</b>                       | 3               | 34 1/2 | 13 1/2 | 40 | 57.0  | <b>\$358.00</b> |
| B-53 <b>U</b>                       | 4               | 34 1/2 | 13 1/2 | 52 | 70.0  | <b>\$458.00</b> |
| B-66 <b>U</b>                       | 5               | 34 1/2 | 13 1/2 | 66 | 90.0  | <b>\$539.00</b> |
| B-78 <b>U</b>                       | 6               | 34 1/2 | 13 1/2 | 78 | 105.0 | <b>\$605.00</b> |
| <b>Extra Shelf for 34 1/2" Wide</b> |                 |        |        |    |       |                 |
| B-345 <b>U</b>                      | —               | 34 1/2 | 13 1/2 | 1  | 7.6   | <b>\$41.00</b>  |



National Motor Freight Class: 175

13 1/2" depth is ideal for storing books and standard sized binders.  
Shelf capacities up to 130 lbs. per shelf, evenly distributed

## WELDED BOOKCASES — 18" DEEP

| CAT. NO.                         | NO. OF OPENINGS | W  | D  | H      | WT.   | PRICE           |
|----------------------------------|-----------------|----|----|--------|-------|-----------------|
| <b>18" Deep Bookcases</b>        |                 |    |    |        |       |                 |
| BC18-30 ●                        | 2               | 36 | 18 | 30     | 47.0  | <b>\$451.00</b> |
| BC18-42 ●                        | 3               | 36 | 18 | 43     | 66.0  | <b>\$511.00</b> |
| BC18-52 ●                        | 4               | 36 | 18 | 55     | 80.0  | <b>\$692.00</b> |
| BC18-72 ●                        | 5               | 36 | 18 | 72     | 107.0 | <b>\$792.00</b> |
| BC18-84 ●                        | 6               | 36 | 18 | 84     | 122.0 | <b>\$819.00</b> |
| <b>Extra Shelf</b>               |                 |    |    |        |       |                 |
| BC18-SHELF ♦                     | —               | 36 | 18 | 1 1/8  | 8.2   | <b>\$43.00</b>  |
| <b>18" Deep Mobile Bookcases</b> |                 |    |    |        |       |                 |
| BC18-30M                         | 2               | 36 | 18 | 36 1/2 | 68.0  | <b>\$564.00</b> |
| BC18-42M                         | 3               | 36 | 18 | 49 1/2 | 81.0  | <b>\$625.00</b> |
| BC18-52M                         | 4               | 36 | 18 | 61 1/2 | 101.0 | <b>\$805.00</b> |
| BC18-72M                         | 5               | 36 | 18 | 78 1/2 | 118.0 | <b>\$906.00</b> |
| <b>Laminate Top*</b>             |                 |    |    |        |       |                 |
| LT-3618                          |                 | 36 | 18 | 5/8    | 15.0  | <b>\$106.00</b> |



\*Laminate Top available in Sable Oak finish.

National Motor Freight Class: 175

Great for storing items with a larger profile; also has a raised base and can be fitted with casters for mobility.  
Shelf capacities up to 150 lbs. per shelf, evenly distributed

## BOOK SUPPORTS

| CAT. NO. | W     | D     | H | WT. | PRICE          |
|----------|-------|-------|---|-----|----------------|
| BSN6     | 4 1/2 | 1 3/4 | 6 | 0.6 | <b>\$11.50</b> |
| BSN9     | 4 1/2 | 1 3/4 | 9 | 1.1 | <b>\$14.00</b> |

Sold individually, not as pairs.

National Motor Freight Class: 85

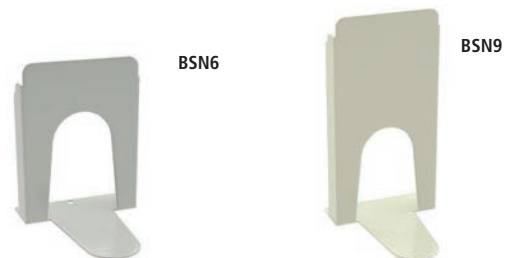

### Standard Colors



♦ ● **U**  
Items with these symbols are available to ship in 2-3 days. Limited quantities and select colors.

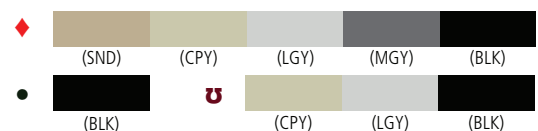

**Product Specifications**

- Full suspension drawers feature three-member, steel ball-bearing suspensions with a limited lifetime warranty.
- Standard dual-point gang lock with safety interlock system.
- One label holder per drawer.
- Four adjustable steel leveling glides.
- All drawers and shelves equipped with standard hanging folder rods for side-to-side letter or legal filing. For filing front-to-back, order cross rods (15CR).

## TWO DRAWER LATERAL FILES



National Motor Freight Class: 175

| CAT. NO.   | DESCRIPTION                     | W  | D        | H       | WT.   | PRICE             |
|------------|---------------------------------|----|----------|---------|-------|-------------------|
| LPL3624L20 | • 36" File, Fixed Drawer Fronts | 36 | 17 15/16 | 27 9/16 | 108.0 | <b>\$1,109.00</b> |
| LPL3624L21 | 36" File, Retractable Doors     | 36 | 17 15/16 | 27 9/16 | 112.0 | <b>1,250.00</b>   |
| LPL4224L20 | • 42" File, Fixed Drawer Fronts | 42 | 17 15/16 | 27 9/16 | 120.0 | <b>1,214.00</b>   |
| LPL4224L21 | 42" File, Retractable Doors     | 42 | 17 15/16 | 27 9/16 | 124.0 | <b>1,369.00</b>   |

NOTE: Tennsco recommends the use of a counterweight (to counterbalance the weight of an open drawer) in all free-standing two-drawer files. To order a counterweight on any lateral file, add a "W" to the model number. Example: LPL3624L20W. Price listed on page 17.

## THREE DRAWER LATERAL FILES



National Motor Freight Class: 175

| CAT. NO.   | DESCRIPTION                     | W  | D        | H      | WT.   | PRICE             |
|------------|---------------------------------|----|----------|--------|-------|-------------------|
| LPL3636L30 | • 36" File, Fixed Drawer Fronts | 36 | 17 15/16 | 39 3/8 | 145.0 | <b>\$1,462.00</b> |
| LPL3636L31 | 36" File, Retractable Doors     | 36 | 17 15/16 | 39 3/8 | 151.0 | <b>1,688.00</b>   |
| LPL4236L30 | 42" File, Fixed Drawer Fronts   | 42 | 17 15/16 | 39 3/8 | 160.0 | <b>1,616.00</b>   |
| LPL4236L31 | 42" File, Retractable Doors     | 42 | 17 15/16 | 39 3/8 | 166.0 | <b>1,848.00</b>   |

## FOUR DRAWER LATERAL FILES



National Motor Freight Class: 175

| CAT. NO.   | DESCRIPTION                     | W  | D        | H      | WT.   | PRICE             |
|------------|---------------------------------|----|----------|--------|-------|-------------------|
| LPL3648L40 | 36" File, Fixed Drawer Fronts   | 36 | 17 15/16 | 51 1/4 | 184.0 | <b>\$1,826.00</b> |
| LPL3648L41 | 36" File, Retractable Doors     | 36 | 17 15/16 | 51 1/4 | 192.0 | <b>2,125.00</b>   |
| LPL4248L40 | • 42" File, Fixed Drawer Fronts | 42 | 17 15/16 | 51 1/4 | 206.0 | <b>1,952.00</b>   |
| LPL4248L41 | 42" File, Retractable Doors     | 42 | 17 15/16 | 51 1/4 | 215.0 | <b>2,295.00</b>   |

## FIVE DRAWER LATERAL FILES



National Motor Freight Class: 175

| CAT. NO.   | DESCRIPTION                   | W  | D        | H  | WT.   | PRICE             |
|------------|-------------------------------|----|----------|----|-------|-------------------|
| LPL3660L50 | • 36" File, Combination Unit* | 36 | 17 15/16 | 65 | 227.0 | <b>\$2,297.00</b> |
| LPL3660L51 | 36" File, Retractable Doors   | 36 | 17 15/16 | 65 | 239.0 | <b>2,597.00</b>   |
| LPL4260L50 | 42" File, Combination Unit*   | 42 | 17 15/16 | 65 | 262.0 | <b>2,457.00</b>   |
| LPL4260L51 | 42" File, Retractable Doors   | 42 | 17 15/16 | 65 | 270.0 | <b>2,800.00</b>   |

\*Top openings is a retractable roll-out drawer; four bottom openings are solid-front doors. For optional Posting Shelf, located 36" from the floor, add a "P" to the end of the model number and add \$85 to the list price. Example: L4260L50P.

**Standard Colors**



• Items with this symbol are available to ship in 2-3 days. Limited quantities and select colors.

• (BLK)

FILING SYSTEMS

# Lateral Files, Overfiles & Accessories

| Inside Drawer Dimensions         | File | Width                            | Depth                             | Height                            |
|----------------------------------|------|----------------------------------|-----------------------------------|-----------------------------------|
| 12" high drawer                  | 30"  | 27 <sup>1</sup> / <sub>4</sub> " | 15 <sup>7</sup> / <sub>16</sub> " | 10 <sup>7</sup> / <sub>16</sub> " |
| with retractable door            | 36"  | 33 <sup>1</sup> / <sub>4</sub> " | 15 <sup>7</sup> / <sub>16</sub> " | 10 <sup>7</sup> / <sub>16</sub> " |
|                                  | 42"  | 39 <sup>1</sup> / <sub>4</sub> " | 15 <sup>7</sup> / <sub>16</sub> " | 10 <sup>7</sup> / <sub>16</sub> " |
| 12" high drawer with fixed front | 30"  | 27 <sup>1</sup> / <sub>4</sub> " | 15 <sup>7</sup> / <sub>16</sub> " | 11 <sup>1</sup> / <sub>8</sub> "  |
|                                  | 36"  | 33 <sup>1</sup> / <sub>4</sub> " | 15 <sup>7</sup> / <sub>16</sub> " | 11 <sup>1</sup> / <sub>8</sub> "  |
|                                  | 42"  | 39 <sup>1</sup> / <sub>4</sub> " | 15 <sup>7</sup> / <sub>16</sub> " | 11 <sup>1</sup> / <sub>8</sub> "  |

- Locks**
- One key unlocks all drawers at once.
  - Locks are core-removable.
  - Locks are keyed randomly. For keyed alike, add suffix "-KA" to model number.
  - Lateral Files and Card Files can be keyed alike if desired.

**Installation guidelines**  
Installation and safety instructions are located in top drawer of all lateral files.

**Counterweights:** To order a factory installed counterweight on any lateral file, add a "W" to the model number. Refer to "Counterweights" chart on p.17 for added cost.

## SIX DRAWER LATERAL FILES

| CAT. NO.   | DESCRIPTION                  | W  | D                                  | H                                | WT.   | PRICE             |
|------------|------------------------------|----|------------------------------------|----------------------------------|-------|-------------------|
| LPL3672L60 | 36" File, Combination Units* | 36 | 17 15 <sup>1</sup> / <sub>16</sub> | 76 7 <sup>7</sup> / <sub>8</sub> | 227.0 | <b>\$2,729.00</b> |
| LPL3672L61 | 36" File, Retractable Doors  | 36 | 17 15 <sup>1</sup> / <sub>16</sub> | 76 7 <sup>7</sup> / <sub>8</sub> | 286.0 | <b>3,009.00</b>   |
| LPL4272L60 | 42" File, Combination Units* | 42 | 17 15 <sup>1</sup> / <sub>16</sub> | 76 7 <sup>7</sup> / <sub>8</sub> | 293.0 | <b>2,960.00</b>   |
| LPL4272L61 | 42" File, Retractable Doors  | 42 | 17 15 <sup>1</sup> / <sub>16</sub> | 76 7 <sup>7</sup> / <sub>8</sub> | 325.0 | <b>3,298.00</b>   |

\*Top two openings are retractable roll-out drawers; four bottom openings are solid-front doors.



FILING SYSTEMS

National Motor Freight Class: 175

## OVERFILES

| CAT. NO.            | W  | D  | H      | WT.  | PRICE           |
|---------------------|----|----|--------|------|-----------------|
| <b>Double Level</b> |    |    |        |      |                 |
| L3620F              | 36 | 18 | 27 1/2 | 76.0 | <b>\$928.00</b> |
| L4220F              | 42 | 18 | 27 1/2 | 89.0 | <b>1,067.00</b> |

Can be attached to top of lateral files.



L3620F

National Motor Freight Class: 175

## LAMINATE TOPS

| CAT. NO. | W  | D  | H      | WT.  | PRICE           |
|----------|----|----|--------|------|-----------------|
| T1836♥   | 36 | 18 | 1 1/16 | 23.0 | <b>\$329.00</b> |
| T1842♥   | 42 | 18 | 1 1/16 | 26.0 | <b>421.00</b>   |

When ordering laminate tops, specify Oak (L006), Mahogany (L005) or Titanium (TTM).



National Motor Freight Class: 70

## COUNTERWEIGHTS

| CAT. NO.                           | W      | D | H      | WT.  | PRICE           |
|------------------------------------|--------|---|--------|------|-----------------|
| <b>For 2-Drawer Files</b>          |        |   |        |      |                 |
| T36CW-4                            | 34 5/8 | — | 10 1/2 | 41.0 | <b>\$167.00</b> |
| T42CW-4                            | 40 5/8 | — | 10 1/2 | 47.0 | <b>195.00</b>   |
| <b>For 3, 4 and 5-Drawer Files</b> |        |   |        |      |                 |
| T36CW-2                            | 34 5/8 | — | 10 1/2 | 20.0 | <b>\$91.00</b>  |
| T42CW-2                            | 40 5/8 | — | 10 1/2 | 24.0 | <b>104.00</b>   |

Used to counterbalance the weight of an open drawer. Attaches to bottom rear of cabinet. Recommended for use with all free standing two-drawer files.



May be pre-installed at factory.

Available in black only. National Motor Freight Class: 70

## CROSS RODS & DIVIDERS

| CAT. NO.                 | W      | D      | H      | WT. | PRICE          |
|--------------------------|--------|--------|--------|-----|----------------|
| <b>Cross Rods (pair)</b> |        |        |        |     |                |
| 15CR●                    | 15 3/4 | 1 7/8  | 7/8    | 1.0 | <b>\$13.00</b> |
| <b>Dividers</b>          |        |        |        |     |                |
| 5AD●                     | —      | 13 1/2 | 6 3/16 | 0.7 | <b>\$7.40</b>  |

Cross rods are used in conjunction with hanging folder rods to file front-to-back. Dividers are used to separate file folders when hanging folder rods are not used.



Available in black only. National Motor Freight Class: 70

### Standard Colors (Unless Otherwise Specified)

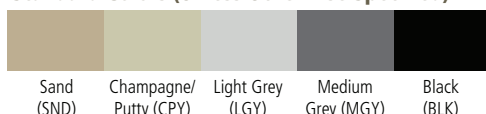

Items with these symbols are available to ship in 2-3 days. Limited quantities and select colors.

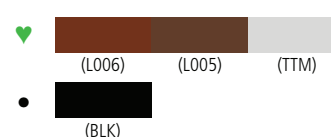

## CARD & MULTIMEDIA FILES



CF-669

CF-758

CF-846

Card files come standard with one center partition and two follower blocks. Units come standard with four levelers for uneven floors.

National Motor Freight Class: 175

| CAT. NO.                      | NO. OF DRAWERS                | W  | D  | H      | WT.   | PRICE      |
|-------------------------------|-------------------------------|----|----|--------|-------|------------|
| <b>Card Files</b>             |                               |    |    |        |       |            |
| CF-669                        | 6                             | 21 | 28 | 52 3/8 | 214.0 | \$2,246.00 |
| CF-758                        | 7                             | 19 | 28 | 52 3/8 | 220.0 | 2,337.00   |
| CF-846                        | 8                             | 15 | 28 | 52 3/8 | 216.0 | 2,444.00   |
| <b>Extra Center Partition</b> |                               |    |    |        |       |            |
| CF-DIV                        | (Available in Black Only)     |    |    |        | 1.0   | \$25.00    |
| <b>Extra Follower Block</b>   |                               |    |    |        |       |            |
| CF-BLK1                       | (For all sizes except CF-669) |    |    |        | 0.5   | \$5.30     |
| CF-BLK2                       | (For CF-669 only)             |    |    |        | 0.5   | 7.60       |

| <b>STORAGE CAPACITIES FOR VARIOUS MEDIA</b> |                  |               |                   |                   |                              |
|---|------------------|---------------|-------------------|-------------------|------------------------------|
| CAT. NO.                                    | CARDS<br>(Sizes) | CDs<br>(Cap.) | CDs<br>(Standard) | CDs<br>(Slimline) | DVD/Blu-Rays<br>(Movie Case) |
| CF-669                                      | 6x9              | 32,600        |                   |                   | 504**                        |
| CF-758                                      | 5x8              | 38,100        | 896*              | 1680*             | 588                          |
| CF-846                                      | 3x5; 4x6         | 43,400        | 1024              | 1920              |                              |

\*Removing center partition increases this number by 1/3.

\*\*DVD/Blu-Rays fit securely when a second center partition (CF-DIV) is inserted.

FILING SYSTEMS

## LITERATURE SORTERS



Letter Size (4075)

Legal Size (5075)

National Motor Freight Class: 100

| CAT. NO.                       | W      | D      | H  | WT.  | PRICE    |
|--------------------------------|--------|--------|----|------|----------|
| <b>Letter Size</b>             |        |        |    |      |          |
| 4075•                          | 30 5/8 | 11 5/8 | 33 | 70.0 | \$697.00 |
| <b>Extra Shelf (Pack of 5)</b> |        |        |    |      |          |
| 4005•                          | 9      | 11     | —  | 6.4  | \$32.00  |
| <b>Legal Size</b>              |        |        |    |      |          |
| 5075•                          | 30 5/8 | 14 5/8 | 33 | 89.0 | \$767.00 |
| <b>Extra Shelf (Pack of 5)</b> |        |        |    |      |          |
| 5005•                          | 9      | 14     | —  | 8.1  | \$39.00  |

Comes standard with 18 shelves (to make 21 openings).

Shelves are adjustable on 1-1/2" centers. Same-depth units can be double-stacked.

## THIRTY DRAWER ORGANIZERS



Letter Size (2085)

Legal Size (3085)



Drawer with  
Optional Divider

| CAT. NO.                               | W      | D      | H       | WT.   | PRICE      |
|--|--------|--------|---------|-------|------------|
| <b>Letter Size</b>                     |        |        |         |       |            |
| 2085♦                                  | 30 5/8 | 11 5/8 | 33      | 95.0  | \$998.00   |
| <b>Legal Size</b>                      |        |        |         |       |            |
| 3085♦                                  | 30 5/8 | 14 5/8 | 33      | 112.0 | \$1,067.00 |
| <b>Optional Dividers (Pack of 30)*</b> |        |        |         |       |            |
| 30AD•                                  | 9 1/16 | —      | 2 11/32 | 6.7   | \$80.00    |

Inside Drawer Dimensions (WxDxH): Letter Size: 9 x 11 1/4 x 2 3/4 Legal Size: 9 x 14 1/4 x 2 3/4

Same-depth units can be double-stacked.

National Motor Freight Class: 100

\*Dividers available in Black only.

## FIXED SHELF LATERAL FILES



Closed Unit

Open Unit

All closed units have doors with long-pull handles and single lock secures all doors.  
National Motor Freight Class: 100

| CAT. NO.             | NO. OF OPENINGS | W  | D  | H      | WT.   | PRICE      |
|----------------------|-----------------|----|----|--------|-------|------------|
| <b>Open Units</b>    |                 |    |    |        |       |            |
| FS350\$              | 5               | 36 | 17 | 63 1/2 | 124.0 | \$1,305.00 |
| FS360\$              | 6               | 36 | 17 | 75 1/4 | 150.0 | 1,429.00   |
| FS370\$              | 7               | 36 | 17 | 87     | 175.0 | 1,613.00   |
| <b>Closed Units</b>  |                 |    |    |        |       |            |
| FS351L\$             | 5               | 36 | 17 | 63 1/2 | 180.0 | \$2,204.00 |
| FS361L\$             | 6               | 36 | 17 | 75 1/4 | 218.0 | 2,559.00   |
| FS371L\$             | 7               | 36 | 17 | 87     | 242.0 | 2,873.00   |
| <b>Extra Divider</b> |                 |    |    |        |       |            |
| FD-1108\$            | —               | —  | 11 | 8      | 0.8   | \$5.00     |

Comes standard with four steel dividers per shelf level; dividers match cabinet color.  
Equipped with shelf-modifier rod to accommodate both letter and legal filing.

### Standard Colors



♦ • \$  
Items with these symbols are available to ship in 2-3 days. Limited quantities and select colors.

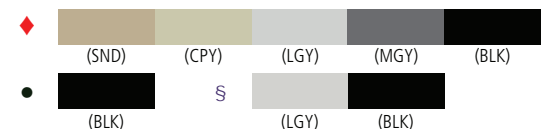

## IMPERIAL SHELVING

| CAT. NO.                  | NO. OF OPENINGS | W  | D  | H   | WT.   | PRICE             |
|---------------------------|-----------------|----|----|-----|-------|-------------------|
| <b>Single Entry Units</b> |                 |    |    |     |       |                   |
| <b>Starter Units</b>      |                 |    |    |     |       |                   |
| 1276PC                    | 6               | 36 | 12 | 76  | 117.0 | <b>\$714.00</b>   |
| 127648PC                  | 6               | 48 | 12 | 76  | 140.0 | <b>\$818.00</b>   |
| 1576PC                    | 6               | 36 | 15 | 76  | 125.0 | <b>\$799.00</b>   |
| 1288PC                    | 7               | 36 | 12 | 88  | 133.0 | <b>\$816.00</b>   |
| 128848PC                  | 7               | 48 | 12 | 88  | 156.0 | <b>\$918.00</b>   |
| 1588PC                    | 7               | 36 | 15 | 88  | 145.0 | <b>\$911.00</b>   |
| <b>Adder Units</b>        |                 |    |    |     |       |                   |
| 1276AC                    | 6               | 36 | 12 | 76  | 108.0 | <b>\$666.00</b>   |
| 127648AC                  | 6               | 48 | 12 | 76  | 130.0 | <b>\$755.00</b>   |
| 1576AC                    | 6               | 36 | 15 | 76  | 114.0 | <b>\$746.00</b>   |
| 1288AC                    | 7               | 36 | 12 | 88  | 125.0 | <b>\$743.00</b>   |
| 128848AC                  | 7               | 48 | 12 | 88  | 147.0 | <b>\$853.00</b>   |
| 1588AC                    | 7               | 36 | 15 | 88  | 132.0 | <b>\$841.00</b>   |
| <b>Double Entry Units</b> |                 |    |    |     |       |                   |
| <b>Starter Units</b>      |                 |    |    |     |       |                   |
| 2476PC                    | 12              | 36 | 24 | 76  | 199.0 | <b>\$1,076.00</b> |
| 247648PC                  | 12              | 48 | 24 | 76  | 247.0 | <b>\$1,257.00</b> |
| 3076PC                    | 12              | 36 | 30 | 76  | 220.0 | <b>\$1,190.00</b> |
| 2488PC                    | 14              | 36 | 24 | 88  | 229.0 | <b>\$1,202.00</b> |
| 248848PC                  | 14              | 48 | 24 | 88  | 286.0 | <b>\$1,431.00</b> |
| 3088PC                    | 14              | 36 | 30 | 88  | 256.0 | <b>\$1,335.00</b> |
| <b>Adder Units</b>        |                 |    |    |     |       |                   |
| 2476AC                    | 12              | 36 | 24 | 76  | 177.0 | <b>\$985.00</b>   |
| 247648AC                  | 12              | 48 | 24 | 76  | 222.0 | <b>\$1,180.00</b> |
| 3076AC                    | 12              | 36 | 30 | 76  | 205.0 | <b>\$1,148.00</b> |
| 2488AC                    | 14              | 36 | 24 | 88  | 203.0 | <b>\$1,113.00</b> |
| 248848AC                  | 14              | 48 | 24 | 88  | 257.0 | <b>\$1,347.00</b> |
| 3088AC                    | 14              | 36 | 30 | 88  | 225.0 | <b>\$1,230.00</b> |
| <b>Reference Shelf</b>    |                 |    |    |     |       |                   |
| RSMB-12                   | —               | 30 | 12 | 5/8 | 9.3   | <b>\$98.00</b>    |
| RSMB-15                   | —               | 30 | 15 | 5/8 | 9.7   | <b>\$100.00</b>   |
| RSMB-24                   | —               | 30 | 24 | 5/8 | 10.8  | <b>\$108.00</b>   |
| RSMB-30                   | —               | 30 | 30 | 5/8 | 11.6  | <b>\$112.00</b>   |
| <b>Extra Shelf Kit</b>    |                 |    |    |     |       |                   |
| ISK-3612                  | —               | 36 | 12 | —   | 13.0  | <b>\$77.00</b>    |
| ISK-3615                  | —               | 36 | 15 | —   | 14.1  | <b>\$88.00</b>    |
| ISK-4812                  | —               | 48 | 12 | —   | 18.8  | <b>\$92.00</b>    |
| ISK-3624                  | —               | 36 | 24 | —   | 24.0  | <b>\$109.00</b>   |
| ISK-3630                  | —               | 36 | 30 | —   | 25.0  | <b>\$133.00</b>   |
| ISK-4824                  | —               | 48 | 24 | —   | 30.0  | <b>\$150.00</b>   |

National Motor Freight Class: 70



Single Entry Unit, 88" Tall



Single Entry Unit, 76" Tall

Single entry units include 5 dividers and one backstop per level



Double Entry Unit, 88" Tall



Double Entry Unit, 76" Tall

Double entry units include 10 dividers and one center stop per level

Double entry units shipped in two cartons. All units have closed upright panels. Plastic feet included to protect carpet. No special tools required for assembly.

National Motor Freight Class: 70

## BACKS FOR IMPERIAL SHELVING



Packed 4 pieces per carton. Top and bottom stiffeners included.

| CAT. NO.              | W  | D | H  | WT.  | PRICE           |
|-----------------------|----|---|----|------|-----------------|
| <b>Two Piece Back</b> |    |   |    |      |                 |
| LTBP-3676-2           | 36 | — | 76 | 18.6 | <b>\$227.00</b> |
| LTBP-4876-2           | 48 | — | 76 | 21.0 | <b>\$291.00</b> |
| LTBP-3688-2           | 36 | — | 88 | 25.0 | <b>\$251.00</b> |
| LTBP-4888-2           | 48 | — | 88 | 29.0 | <b>\$322.00</b> |

National Motor Freight Class: 70

### Standard Colors



Items with these symbols are available to ship in 2-3 days. Limited quantities and select colors.



## REGAL SHELVING



| CAT. NO.             | NO. OF OPENINGS | W  | D  | H  | SHELF CAPACITY | WT.   | PRICE    |
|----------------------|-----------------|----|----|----|----------------|-------|----------|
| <b>Starter Units</b> |                 |    |    |    |                |       |          |
| RGL-1836S            | 5               | 36 | 18 | 76 | 500            | 104.0 | \$458.00 |
| <b>Adder Units</b>   |                 |    |    |    |                |       |          |
| RGL-1836A            | 5               | 36 | 18 | 76 | 500            | 100.0 | \$413.00 |

Color: Sand only with Oak woodgrain particleboard shelf.  
Completely boltless assembly; only rubber mallet needed for assembly.  
Plastic feet included to protect carpets.  
National Motor Freight Class: 70

## CAPSTONE SHELVING



Color: Medium Grey only.  
National Motor Freight Class: 70

| CAT. NO.             | NO. OF OPENINGS | W  | D  | H  | WT.   | PRICE                | CAT. NO.      | SHELF CAPACITY | WT.  | PRICE    |
|----------------------|-----------------|----|----|----|-------|----------------------|---------------|----------------|------|----------|
| <b>Starter Units</b> |                 |    |    |    |       | <b>Extra Shelves</b> |               |                |      |          |
| CS187636-MGY         | 4               | 36 | 18 | 76 | 105.0 | \$606.00             | CESL-3618-MGY | 500            | 12.0 | \$84.00  |
| CS187642-MGY         | 4               | 42 | 18 | 76 | 114.0 | \$655.00             | CESL-4218-MGY | 500            | 13.0 | \$91.00  |
| CS187648-MGY         | 4               | 48 | 18 | 76 | 122.0 | \$697.00             | CESL-4818-MGY | 350            | 17.0 | \$98.00  |
| CS247636-MGY         | 4               | 36 | 24 | 76 | 123.0 | \$636.00             | CESL-3624-MGY | 400            | 14.0 | \$85.00  |
| CS247642-MGY         | 4               | 42 | 24 | 76 | 134.0 | \$717.00             | CESL-4224-MGY | 500            | 16.0 | \$104.00 |
| CS247648-MGY         | 4               | 48 | 24 | 76 | 144.0 | \$745.00             | CESL-4824-MGY | 450            | 20.0 | \$127.00 |
| CS188836-MGY         | 5               | 36 | 18 | 88 | 110.0 | \$613.00             | CESL-3618-MGY | 500            | 12.0 | \$84.00  |
| CS188842-MGY         | 5               | 42 | 18 | 88 | 119.0 | \$657.00             | CESL-4218-MGY | 500            | 13.0 | \$91.00  |
| CS188848-MGY         | 5               | 48 | 18 | 88 | 127.0 | \$704.00             | CESL-4818-MGY | 350            | 17.0 | \$98.00  |
| CS248836-MGY         | 5               | 36 | 24 | 88 | 130.0 | \$685.00             | CESL-3624-MGY | 400            | 14.0 | \$85.00  |
| CS248842-MGY         | 5               | 42 | 24 | 88 | 141.0 | \$777.00             | CESL-4224-MGY | 500            | 16.0 | \$104.00 |
| CS248848-MGY         | 5               | 48 | 24 | 88 | 151.0 | \$806.00             | CESL-4824-MGY | 450            | 20.0 | \$127.00 |
| <b>Adder Units</b>   |                 |    |    |    |       | <b>Extra Shelves</b> |               |                |      |          |
| CA187636-MGY         | 4               | 36 | 18 | 76 | 85.0  | \$515.00             | CESL-3618-MGY | 500            | 12.0 | \$84.00  |
| CA187642-MGY         | 4               | 42 | 18 | 76 | 94.0  | \$559.00             | CESL-4218-MGY | 500            | 13.0 | \$91.00  |
| CA187648-MGY         | 4               | 48 | 18 | 76 | 102.0 | \$599.00             | CESL-4818-MGY | 350            | 17.0 | \$98.00  |
| CA247636-MGY         | 4               | 36 | 24 | 76 | 100.0 | \$560.00             | CESL-3624-MGY | 400            | 14.0 | \$85.00  |
| CA247642-MGY         | 4               | 42 | 24 | 76 | 111.0 | \$634.00             | CESL-4224-MGY | 500            | 16.0 | \$104.00 |
| CA247648-MGY         | 4               | 48 | 24 | 76 | 121.0 | \$672.00             | CESL-4824-MGY | 450            | 20.0 | \$127.00 |
| CA188836-MGY         | 5               | 36 | 18 | 88 | 95.0  | \$531.00             | CESL-3618-MGY | 500            | 12.0 | \$84.00  |
| CA188842-MGY         | 5               | 42 | 18 | 88 | 104.0 | \$574.00             | CESL-4218-MGY | 500            | 13.0 | \$91.00  |
| CA188848-MGY         | 5               | 48 | 18 | 88 | 112.0 | \$616.00             | CESL-4818-MGY | 350            | 17.0 | \$98.00  |
| CA248836-MGY         | 5               | 36 | 24 | 88 | 111.0 | \$602.00             | CESL-3624-MGY | 400            | 14.0 | \$85.00  |
| CA248842-MGY         | 5               | 42 | 24 | 88 | 122.0 | \$694.00             | CESL-4224-MGY | 500            | 16.0 | \$104.00 |
| CA248848-MGY         | 5               | 48 | 24 | 88 | 132.0 | \$720.00             | CESL-4824-MGY | 450            | 20.0 | \$127.00 |

## COMMERCIAL CLIP SHELVING PACKAGE



Open-Style



Closed-Style

Color: Medium Grey only.  
Individually cartoned.  
National Motor Freight classification: Class 70

| CAT. NO.                           | NO. OF OPENINGS | W  | D  | H  | SHELF CAPACITY | WT.   | PRICE    |
|------------------------------------|-----------------|----|----|----|----------------|-------|----------|
| <b>Open-Style Shelving Units</b>   |                 |    |    |    |                |       |          |
| ESP-1236♣                          | 4               | 36 | 12 | 75 | 250            | 48.0  | \$287.00 |
| ESP-1836♣                          | 4               | 36 | 18 | 75 | 250            | 61.0  | \$342.00 |
| ESP-2436♣                          | 4               | 36 | 24 | 75 | 250            | 73.0  | \$430.00 |
| ESP-6-1236♣                        | 5               | 36 | 12 | 75 | 250            | 53.0  | \$316.00 |
| ESP-6-1836♣                        | 5               | 36 | 18 | 75 | 250            | 68.0  | \$377.00 |
| ESP-6-2436♣                        | 5               | 36 | 24 | 75 | 250            | 77.0  | \$462.00 |
| <b>Closed-Style Shelving Units</b> |                 |    |    |    |                |       |          |
| ESPC-1236♣                         | 4               | 36 | 12 | 75 | 250            | 72.0  | \$483.00 |
| ESPC-1836♣                         | 4               | 36 | 18 | 75 | 250            | 94.0  | \$512.00 |
| ESPC-2436♣                         | 4               | 36 | 24 | 75 | 250            | 112.0 | \$606.00 |
| ESPC-6-1236♣                       | 5               | 36 | 12 | 75 | 250            | 78.0  | \$505.00 |
| ESPC-6-1836♣                       | 5               | 36 | 18 | 75 | 250            | 108.0 | \$557.00 |
| ESPC-6-2436♣                       | 5               | 36 | 24 | 75 | 250            | 121.0 | \$650.00 |
| <b>Extra Shelves*</b>              |                 |    |    |    |                |       |          |
| ES-12♣                             | -               | 36 | 12 | 1  | 250            | 6.0   | \$35.00  |
| ES-18♣                             | -               | 36 | 18 | 1  | 250            | 8.2   | \$42.00  |
| ES-24♣                             | -               | 36 | 24 | 1  | 250            | 10.8  | \$53.00  |

\*Shelves packaged as pairs; priced per shelf.

### Standard Colors (Unless Otherwise Specified)

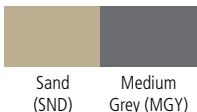

Items with these symbols are available to ship in 2-3 days.  
Limited quantities and select colors.



# Single Tier Lockers

† Welded frames are riveted to welded locker body.

## SINGLE TIER LOCKERS WITH LEGS

| WELDED†        |             |            | UNASSEMBLED    |             |            | DIMENSIONS |         |    |    |              |    |    |
|----------------|-------------|------------|----------------|-------------|------------|------------|---------|----|----|--------------|----|----|
| CATALOG NUMBER | UNIT WEIGHT | UNIT PRICE | CATALOG NUMBER | UNIT WEIGHT | UNIT PRICE | OPEN-INGS  | OPENING |    |    | OVERALL UNIT |    |    |
|                |             |            |                |             |            |            | W       | D  | H  | W            | D  | H  |
| STS-121260-1   | 52          | \$539.00   | STK-121260-1   | 51          | \$452.00   | 1          | 12      | 12 | 60 | 12           | 12 | 66 |
| STS-121260-3   | 132         | 1,266.00   | STK-121260-3   | 130         | 1,142.00   | 3          | 12      | 12 | 60 | 36           | 12 | 66 |
| STS-121560-1   | 55          | 562.00     | STK-121560-1   | 54          | 480.00     | 1          | 12      | 15 | 60 | 12           | 15 | 66 |
| STS-121560-3   | 140         | 1,302.00   | STK-121560-3   | 137         | 1,193.00   | 3          | 12      | 15 | 60 | 36           | 15 | 66 |
| STS-121860-1   | 59          | 586.00     | STK-121860-1   | 58          | 511.00     | 1          | 12      | 18 | 60 | 12           | 18 | 66 |
| STS-121860-3   | 150         | 1,393.00   | STK-121860-3   | 147         | 1,248.00   | 3          | 12      | 18 | 60 | 36           | 18 | 66 |
| STS-151560-1   | 55          | 619.00     | -              | -           | -          | 1          | 15      | 15 | 60 | 15           | 15 | 66 |
| STS-151560-3   | 140         | 1,444.00   | -              | -           | -          | 3          | 15      | 15 | 60 | 45           | 15 | 66 |
| STS-151860-1   | 60          | 641.00     | -              | -           | -          | 1          | 15      | 18 | 60 | 15           | 18 | 66 |
| STS-151860-3   | 150         | 1,515.00   | -              | -           | -          | 3          | 15      | 18 | 60 | 45           | 18 | 66 |
| STS-121272-1   | 61          | \$589.00   | STK-121272-1   | 60          | \$507.00   | 1          | 12      | 12 | 72 | 12           | 12 | 78 |
| STS-121272-3   | 156         | 1,384.00   | STK-121272-3   | 153         | 1,213.00   | 3          | 12      | 12 | 72 | 36           | 12 | 78 |
| STS-121572-1▲  | 65          | 615.00     | STK-121572-1   | 63          | 494.00     | 1          | 12      | 15 | 72 | 12           | 15 | 78 |
| STS-121572-3▲  | 164         | 1,410.00   | STK-121572-3   | 161         | 1,232.00   | 3          | 12      | 15 | 72 | 36           | 15 | 78 |
| STS-121872-1▲  | 69          | 634.00     | STK-121872-1♣  | 68          | 509.00     | 1          | 12      | 18 | 72 | 12           | 18 | 78 |
| STS-121872-3▲  | 173         | 1,463.00   | STK-121872-3♣  | 170         | 1,300.00   | 3          | 12      | 18 | 72 | 36           | 18 | 78 |
| STS-151572-1▲  | 70          | 679.00     | STK-151572-1   | 69          | 592.00     | 1          | 15      | 15 | 72 | 15           | 15 | 78 |
| STS-151572-3▲  | 179         | 1,563.00   | STK-151572-3   | 176         | 1,424.00   | 3          | 15      | 15 | 72 | 45           | 15 | 78 |
| STS-151872-1▲  | 76          | 679.00     | STK-151872-1♣  | 74          | 544.00     | 1          | 15      | 18 | 72 | 15           | 18 | 78 |
| STS-151872-3▲  | 196         | 1,588.00   | STK-151872-3♣  | 192         | 1,424.00   | 3          | 15      | 18 | 72 | 45           | 18 | 78 |
| STS-152172-1   | 81          | 766.00     | STK-152172-1   | 80          | 729.00     | 1          | 15      | 21 | 72 | 15           | 21 | 78 |
| STS-152172-3   | 207         | 1,692.00   | STK-152172-3   | 203         | 1,572.00   | 3          | 15      | 21 | 72 | 45           | 21 | 78 |
| STS-181872-1♣  | 82          | 758.00     | -              | -           | -          | 1          | 18      | 18 | 72 | 18           | 18 | 78 |
| STS-182172-1♣  | 92          | 808.00     | STK-182172-1   | 90          | 709.00     | 1          | 18      | 21 | 72 | 18           | 21 | 78 |
| STS-182172-2   | 161         | 1,443.00   | -              | -           | -          | 2          | 18      | 21 | 72 | 36           | 21 | 78 |
| -              | -           | -          | STK-182172-3   | 277         | 1,729.00   | 3          | 18      | 21 | 72 | 54           | 21 | 78 |
| STS-242472-1♣  | 113         | 940.00     | -              | -           | -          | 1          | 24      | 24 | 72 | 24           | 24 | 78 |



STS-121872-3



STS-121872-1

Other sizes available. Call factory for prices and delivery.  
National Motor Freight Class:  
Welded, 175;  
Unassembled, 85  
National Motor Freight Class

## SINGLE TIER LOCKERS WITHOUT LEGS

| WELDED†        |             |            | UNASSEMBLED    |             |            | DIMENSIONS |         |    |    |              |    |    |
|----------------|-------------|------------|----------------|-------------|------------|------------|---------|----|----|--------------|----|----|
| CATALOG NUMBER | UNIT WEIGHT | UNIT PRICE | CATALOG NUMBER | UNIT WEIGHT | UNIT PRICE | OPEN-INGS  | OPENING |    |    | OVERALL UNIT |    |    |
|                |             |            |                |             |            |            | W       | D  | H  | W            | D  | H  |
| STS-121260-A   | 50          | \$526.00   | STK-121260-A   | 49          | \$537.00   | 1          | 12      | 12 | 60 | 12           | 12 | 60 |
| STS-121260-C   | 127         | 1,254.00   | STK-121260-C   | 125         | 1,189.00   | 3          | 12      | 12 | 60 | 36           | 12 | 60 |
| STS-121560-A   | 53          | 560.00     | STK-121560-A   | 52          | 499.00     | 1          | 12      | 15 | 60 | 12           | 15 | 60 |
| STS-121560-C   | 135         | 1,246.00   | STK-121560-C   | 133         | 1,223.00   | 3          | 12      | 15 | 60 | 36           | 15 | 60 |
| STS-121860-A   | 57          | 615.00     | STK-121860-A   | 56          | 562.00     | 1          | 12      | 18 | 60 | 12           | 18 | 60 |
| STS-121860-C   | 145         | 1,399.00   | STK-121860-C   | 142         | 1,287.00   | 3          | 12      | 18 | 60 | 36           | 18 | 60 |
| STS-151560-A   | 53          | 636.00     | STK-151560-A*  | 52          | 529.00     | 1          | 15      | 15 | 60 | 15           | 15 | 60 |
| STS-151560-C   | 135         | 1,394.00   | -              | -           | -          | 3          | 15      | 15 | 60 | 45           | 15 | 60 |
| STS-151860-A   | 55          | 661.00     | STK-151860-A   | 54          | 617.00     | 1          | 15      | 18 | 60 | 15           | 18 | 60 |
| STS-151860-C   | 145         | 1,496.00   | STK-151860-C   | 142         | 1,461.00   | 3          | 15      | 18 | 60 | 45           | 18 | 60 |
| STS-181860-A   | 69          | 767.00     | -              | -           | -          | 1          | 18      | 18 | 60 | 18           | 18 | 60 |
| STS-121272-A   | 59          | 559.00     | STK-121272-A   | 58          | 552.00     | 1          | 12      | 12 | 72 | 12           | 12 | 72 |
| STS-121272-C   | 147         | 1,348.00   | STK-121272-C   | 145         | 1,265.00   | 3          | 12      | 12 | 72 | 36           | 12 | 72 |
| STS-121572-A   | 64          | 592.00     | STK-121572-A   | 62          | 570.00     | 1          | 12      | 15 | 72 | 12           | 15 | 72 |
| STS-121572-C   | 159         | 1,367.00   | STK-121572-C   | 156         | 1,303.00   | 3          | 12      | 15 | 72 | 36           | 15 | 72 |
| STS-121872-A▲  | 68          | 607.00     | STK-121872-A   | 66          | 549.00     | 1          | 12      | 18 | 72 | 12           | 18 | 72 |
| STS-121872-C▲  | 169         | 1,410.00   | STK-121872-C   | 166         | 1,402.00   | 3          | 12      | 18 | 72 | 36           | 18 | 72 |
| STS-151572-A   | 73          | 647.00     | -              | -           | -          | 1          | 15      | 15 | 72 | 15           | 15 | 72 |
| STS-151572-C   | 182         | 1,535.00   | -              | -           | -          | 3          | 15      | 15 | 72 | 45           | 15 | 72 |
| STS-151872-A   | 76          | 650.00     | STK-151872-A♣  | 75          | 602.00     | 1          | 15      | 18 | 72 | 15           | 18 | 72 |
| STS-151872-C   | 191         | 1,559.00   | STK-151872-C♣  | 187         | 1,408.00   | 3          | 15      | 18 | 72 | 45           | 18 | 72 |
| STS-152172-A   | 81          | 770.00     | STK-152172-A   | 80          | 730.00     | 1          | 15      | 21 | 72 | 15           | 21 | 72 |
| STS-152172-C   | 202         | 1,656.00   | STK-152172-C   | 199         | 1,557.00   | 3          | 15      | 21 | 72 | 45           | 21 | 72 |
| STS-182172-A   | 86          | 786.00     | STK-182172-A   | 84          | 696.00     | 1          | 18      | 21 | 72 | 18           | 21 | 72 |
| STS-182172-B   | 151         | 1,393.00   | -              | -           | -          | 2          | 18      | 21 | 72 | 36           | 21 | 72 |
| -              | -           | -          | STK-182172-C   | 105         | 1,692.00   | 3          | 18      | 21 | 72 | 54           | 21 | 72 |
| STS-242472-A♣  | 107         | 892.00     | -              | -           | -          | 1          | 24      | 24 | 72 | 24           | 24 | 72 |



STS-121872-C



STS-121872-A

Other sizes available. Call factory for prices and delivery.  
National Motor Freight Class:  
Welded, 175;  
Unassembled, 85

\*Set-up charges will be applied, contact factory for pricing.

### Standard Colors



▲ ♣  
Items with these symbols are available to ship in 2-3 days. Limited quantities and select colors.

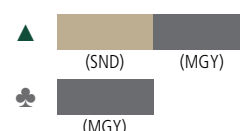

# Double Tier Lockers

† Welded frames are riveted to welded locker body.

## DOUBLE TIER LOCKERS WITH LEGS



DTS-121836-3



DTS-121836-1

Other sizes available. Call factory for prices and delivery.

National Motor Freight Class:

Welded, 175;

Unassembled, 85

| WELDED†        |             |            | UNASSEMBLED    |             |            | DIMENSIONS |         |    |    |              |    |    |
|----------------|-------------|------------|----------------|-------------|------------|------------|---------|----|----|--------------|----|----|
| CATALOG NUMBER | UNIT WEIGHT | UNIT PRICE | CATALOG NUMBER | UNIT WEIGHT | UNIT PRICE | OPENINGS   | OPENING |    |    | OVERALL UNIT |    |    |
|                |             |            |                |             |            |            | W       | D  | H  | W            | D  | H  |
| DTS-121230-1   | 54          | \$564.00   | DTK-121230-1   | 53          | \$505.00   | 2          | 12      | 12 | 30 | 12           | 12 | 66 |
| DTS-121230-3   | 134         | 1,389.00   | DTK-121230-3   | 132         | 1,292.00   | 6          | 12      | 12 | 30 | 36           | 12 | 66 |
| DTS-121530-1   | 59          | 645.00     | DTK-121530-1   | 58          | 510.00     | 2          | 12      | 15 | 30 | 12           | 15 | 66 |
| DTS-121530-3   | 148         | 1,472.00   | DTK-121530-3   | 145         | 1,272.00   | 6          | 12      | 15 | 30 | 36           | 15 | 66 |
| DTS-121830-1   | 64          | 660.00     | DTK-121830-1   | 63          | 513.00     | 2          | 12      | 18 | 30 | 12           | 18 | 66 |
| DTS-121830-3   | 160         | 1,459.00   | DTK-121830-3   | 157         | 1,304.00   | 6          | 12      | 18 | 30 | 36           | 18 | 66 |
| DTS-151530-1   | 64          | 692.00     | DTK-151530-1   | 63          | 613.00     | 2          | 15      | 15 | 30 | 15           | 15 | 66 |
| DTS-151530-3   | 160         | 1,643.00   | DTK-151530-3   | 157         | 1,531.00   | 6          | 15      | 15 | 30 | 45           | 15 | 66 |
| DTS-151830-1   | 69          | 714.00     | DTK-151830-1   | 68          | 626.00     | 2          | 15      | 18 | 30 | 15           | 18 | 66 |
| DTS-151830-3   | 173         | 1,686.00   | DTK-151830-3   | 169         | 1,535.00   | 6          | 15      | 18 | 30 | 45           | 18 | 66 |
| DTS-121236-1▲  | 63          | 622.00     | DTK-121236-1♣  | 61          | 500.00     | 2          | 12      | 12 | 36 | 12           | 12 | 78 |
| DTS-121236-3▲  | 156         | 1,469.00   | DTK-121236-3♣  | 153         | 1,302.00   | 6          | 12      | 12 | 36 | 36           | 12 | 78 |
| DTS-121536-1▲  | 66          | 645.00     | DTK-121536-1♣  | 65          | 522.00     | 2          | 12      | 15 | 36 | 12           | 15 | 78 |
| DTS-121536-3▲  | 164         | 1,500.00   | DTK-121536-3♣  | 161         | 1,322.00   | 6          | 12      | 15 | 36 | 36           | 15 | 78 |
| DTS-121836-1▲  | 70          | 660.00     | DTK-121836-1♣  | 69          | 532.00     | 2          | 12      | 18 | 36 | 12           | 18 | 78 |
| DTS-121836-3▲  | 175         | 1,531.00   | DTK-121836-3♣  | 172         | 1,367.00   | 6          | 12      | 18 | 36 | 36           | 18 | 78 |
| DTS-151536-1   | 75          | 698.00     | DTK-151536-1   | 74          | 613.00     | 2          | 15      | 15 | 36 | 15           | 15 | 78 |
| DTS-151536-3   | 187         | 1,705.00   | DTK-151536-3   | 184         | 1,542.00   | 6          | 15      | 15 | 36 | 45           | 15 | 78 |
| DTS-151836-1▲  | 77          | 724.00     | DTK-151836-1   | 75          | 594.00     | 2          | 15      | 18 | 36 | 15           | 18 | 78 |
| DTS-151836-3▲  | 196         | 1,739.00   | DTK-151836-3   | 193         | 1,506.00   | 6          | 15      | 18 | 36 | 45           | 18 | 78 |

## DOUBLE TIER LOCKERS WITHOUT LEGS



DTS-121836-C



DTS-121836-A

Other sizes available. Call factory for prices and delivery.

National Motor Freight Class:

Welded, 175;

Unassembled, 85

| WELDED†        |             |            | UNASSEMBLED    |             |            | DIMENSIONS |         |    |    |              |    |    |
|----------------|-------------|------------|----------------|-------------|------------|------------|---------|----|----|--------------|----|----|
| CATALOG NUMBER | UNIT WEIGHT | UNIT PRICE | CATALOG NUMBER | UNIT WEIGHT | UNIT PRICE | OPENINGS   | OPENING |    |    | OVERALL UNIT |    |    |
|                |             |            |                |             |            |            | W       | D  | H  | W            | D  | H  |
| DTS-121230-A   | 48          | \$549.00   | DTK-121230-A   | 47          | \$458.00   | 2          | 12      | 12 | 30 | 12           | 12 | 60 |
| DTS-121230-C   | 120         | 1,308.00   | DTK-121230-C   | 118         | 1,265.00   | 6          | 12      | 12 | 30 | 36           | 12 | 60 |
| DTS-121530-A   | 52          | 586.00     | DTK-121530-A   | 51          | 481.00     | 2          | 12      | 15 | 30 | 12           | 15 | 60 |
| DTS-121530-C   | 130         | 1,414.00   | DTK-121530-C   | 128         | 1,206.00   | 6          | 12      | 15 | 30 | 36           | 15 | 60 |
| DTS-121830-A   | 57          | 589.00     | DTK-121830-A   | 56          | 499.00     | 2          | 12      | 18 | 30 | 12           | 18 | 60 |
| DTS-121830-C   | 145         | 1,443.00   | DTK-121830-C   | 142         | 1,331.00   | 6          | 12      | 18 | 30 | 36           | 18 | 60 |
| DTS-151530-A   | 62          | 650.00     | -              | -           | -          | 2          | 15      | 15 | 30 | 15           | 15 | 60 |
| DTS-151530-C   | 155         | 1,602.00   | DTK-151530-C*  | 152         | 1,518.00   | 6          | 15      | 15 | 30 | 45           | 15 | 60 |
| DTS-151830-A   | 67          | 662.00     | DTK-151830-A   | 66          | 623.00     | 2          | 15      | 18 | 30 | 15           | 18 | 60 |
| DTS-151830-C   | 167         | 1,667.00   | DTK-151830-C   | 164         | 1,473.00   | 6          | 15      | 18 | 30 | 45           | 18 | 60 |
| DTS-121236-A   | 60          | 597.00     | DTK-121236-A   | 59          | 537.00     | 2          | 12      | 12 | 36 | 12           | 12 | 72 |
| DTS-121236-C▲  | 153         | 1,442.00   | DTK-121236-C   | 150         | 1,272.00   | 6          | 12      | 12 | 36 | 36           | 12 | 72 |
| DTS-121536-A   | 63          | 622.00     | DTK-121536-A   | 62          | 518.00     | 2          | 12      | 15 | 36 | 12           | 15 | 72 |
| DTS-121536-C▲  | 160         | 1,477.00   | DTK-121536-C   | 158         | 1,329.00   | 6          | 12      | 15 | 36 | 36           | 15 | 72 |
| DTS-121836-A▲  | 68          | 630.00     | DTK-121836-A   | 66          | 529.00     | 2          | 12      | 18 | 36 | 12           | 18 | 72 |
| DTS-121836-C▲  | 171         | 1,481.00   | DTK-121836-C   | 168         | 1,375.00   | 6          | 12      | 18 | 36 | 36           | 18 | 72 |
| DTS-151536-A   | 73          | 683.00     | DTK-151536-A*  | 72          | 547.00     | 2          | 15      | 15 | 36 | 15           | 15 | 72 |
| DTS-151536-C   | 183         | 1,667.00   | DTK-151536-C   | 180         | 1,405.00   | 6          | 15      | 15 | 36 | 45           | 15 | 72 |
| DTS-151836-A   | 77          | 707.00     | DTK-151836-A   | 76          | 605.00     | 2          | 15      | 18 | 36 | 15           | 18 | 72 |
| DTS-151836-C   | 193         | 1,701.00   | DTK-151836-C   | 189         | 1,489.00   | 6          | 15      | 18 | 36 | 45           | 18 | 72 |

\*Set-up charges will be applied, contact factory for pricing.

### Standard Colors



Sand (SND) Champagne/Putty (CPY) Light Grey (LGY) Medium Grey (MGY) Black (BLK)

▲ ♣  
Items with these symbols are available to ship in 2-3 days. Limited quantities and select colors.

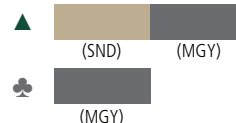

# Triple Tier Lockers

† Welded frames are riveted to welded locker body.

## TRIPLE TIER LOCKERS WITH LEGS

| WELDED†        |             |            | DIMENSIONS    |         |    |    |              |    |    |
|----------------|-------------|------------|---------------|---------|----|----|--------------|----|----|
| CATALOG NUMBER | UNIT WEIGHT | UNIT PRICE | # OF OPENINGS | OPENING |    |    | OVERALL UNIT |    |    |
|                |             |            |               | W       | D  | H  | W            | D  | H  |
| TTS-121224-1   | 61          | \$696.00   | 3             | 12      | 12 | 24 | 12           | 12 | 78 |
| TTS-121224-3   | 153         | 1,729.00   | 9             | 12      | 12 | 24 | 36           | 12 | 78 |
| TTS-121524-1   | 68          | 729.00     | 3             | 12      | 15 | 24 | 12           | 15 | 78 |
| TTS-121524-3   | 173         | 1,825.00   | 9             | 12      | 15 | 24 | 36           | 15 | 78 |
| TTS-121824-1   | 72          | 747.00     | 3             | 12      | 18 | 24 | 12           | 18 | 78 |
| TTS-121824-3   | 184         | 1,852.00   | 9             | 12      | 18 | 24 | 36           | 18 | 78 |
| TTS-151524-1   | 66          | 819.00     | 3             | 15      | 15 | 24 | 15           | 15 | 78 |
| TTS-151524-3   | 165         | 2,003.00   | 9             | 15      | 15 | 24 | 45           | 15 | 78 |
| TTS-151824-1   | 71          | 812.00     | 3             | 15      | 18 | 24 | 15           | 18 | 78 |
| TTS-151824-3   | 178         | 2,066.00   | 9             | 15      | 18 | 24 | 45           | 18 | 78 |



TTS-121824-3

TTS-121824-1

Other sizes available. Call factory for prices and delivery.

National Motor Freight Class:  
Welded, 175;  
Unassembled, 85

## TRIPLE TIER LOCKERS WITHOUT LEGS

| WELDED†        |             |            | DIMENSIONS    |         |    |    |              |    |    |
|----------------|-------------|------------|---------------|---------|----|----|--------------|----|----|
| CATALOG NUMBER | UNIT WEIGHT | UNIT PRICE | # OF OPENINGS | OPENING |    |    | OVERALL UNIT |    |    |
|                |             |            |               | W       | D  | H  | W            | D  | H  |
| TTS-121224-A   | 63          | \$725.00   | 3             | 12      | 12 | 24 | 12           | 12 | 72 |
| TTS-121224-C   | 159         | 1,719.00   | 9             | 12      | 12 | 24 | 36           | 12 | 72 |
| TTS-121524-A   | 66          | 707.00     | 3             | 12      | 15 | 24 | 12           | 15 | 72 |
| TTS-121524-C   | 166         | 1,787.00   | 9             | 12      | 15 | 24 | 36           | 15 | 72 |
| TTS-121824-A   | 71          | 737.00     | 3             | 12      | 18 | 24 | 12           | 18 | 72 |
| TTS-121824-C   | 179         | 1,840.00   | 9             | 12      | 18 | 24 | 36           | 18 | 72 |
| TTS-151524-A   | 67          | 775.00     | 3             | 15      | 15 | 24 | 15           | 15 | 72 |
| TTS-151524-C   | 168         | 1,991.00   | 9             | 15      | 15 | 24 | 45           | 15 | 72 |
| TTS-151824-A   | 72          | 801.00     | 3             | 15      | 18 | 24 | 15           | 18 | 72 |
| TTS-151824-C   | 180         | 1,982.00   | 9             | 15      | 18 | 24 | 45           | 18 | 72 |



TTS-121824-C

TTS-121824-A

Other sizes available. Call factory for prices and delivery.

National Motor Freight Class:  
Welded, 175;  
Unassembled, 85

### Standard Colors



Sand (SND) Champagne/ Putty (CPY) Light Grey (LGY) Medium Grey (MGY) Black (BLK)

# Box Lockers

† Welded frames are riveted to welded locker body.

## 5-TIER BOX LOCKERS WITH LEGS



| WELDED†        |             |            | UNASSEMBLED    |             |            | DIMENSIONS |         |    |    |              |    |    |
|----------------|-------------|------------|----------------|-------------|------------|------------|---------|----|----|--------------|----|----|
| CATALOG NUMBER | UNIT WEIGHT | UNIT PRICE | CATALOG NUMBER | UNIT WEIGHT | UNIT PRICE | OPEN-INGS  | OPENING |    |    | OVERALL UNIT |    |    |
|                |             |            |                |             |            |            | W       | D  | H  | W            | D  | H  |
| BS5-121212-1   | 52          | \$556.00   | --             | --          | --         | 5          | 12      | 12 | 12 | 12           | 12 | 66 |
| BS5-121212-3   | 131         | 1,202.00   | --             | --          | --         | 15         | 12      | 12 | 12 | 36           | 12 | 66 |
| BS5-121512-1▲  | 56          | 590.00     | --             | --          | --         | 5          | 12      | 15 | 12 | 12           | 15 | 66 |
| BS5-121512-3▲  | 141         | 1,331.00   | --             | --          | --         | 15         | 12      | 15 | 12 | 36           | 15 | 66 |
| BS5-121812-1   | 61          | 613.00     | --             | --          | --         | 5          | 12      | 18 | 12 | 12           | 18 | 66 |
| BS5-121812-3   | 152         | 1,394.00   | --             | --          | --         | 15         | 12      | 18 | 12 | 36           | 18 | 66 |
| BS5-151512-1   | 64          | 721.00     | --             | --          | --         | 5          | 15      | 15 | 12 | 15           | 15 | 66 |
| BS5-151512-3   | 161         | 1,557.00   | --             | --          | --         | 15         | 15      | 15 | 12 | 45           | 15 | 66 |
| BS5-151812-1   | 67          | 707.00     | --             | --          | --         | 5          | 15      | 18 | 12 | 15           | 18 | 66 |
| BS5-151812-3   | 167         | 1,640.00   | --             | --          | --         | 15         | 15      | 18 | 12 | 45           | 18 | 66 |

National Motor Freight Class: Welded, 175. Other sizes available. Call factory for pricing.

## 5-TIER BOX LOCKERS WITHOUT LEGS



| WELDED†        |             |            | UNASSEMBLED    |             |            | DIMENSIONS |         |    |    |              |    |    |
|----------------|-------------|------------|----------------|-------------|------------|------------|---------|----|----|--------------|----|----|
| CATALOG NUMBER | UNIT WEIGHT | UNIT PRICE | CATALOG NUMBER | UNIT WEIGHT | UNIT PRICE | OPEN-INGS  | OPENING |    |    | OVERALL UNIT |    |    |
|                |             |            |                |             |            |            | W       | D  | H  | W            | D  | H  |
| BS5-121212-A   | 50          | \$547.00   | --             | --          | --         | 5          | 12      | 12 | 12 | 12           | 12 | 60 |
| BS5-121212-C   | 126         | 1,214.00   | --             | --          | --         | 15         | 12      | 12 | 12 | 36           | 12 | 60 |
| BS5-121512-A   | 54          | 583.00     | --             | --          | --         | 5          | 12      | 15 | 12 | 12           | 15 | 60 |
| BS5-121512-C   | 136         | 1,246.00   | --             | --          | --         | 15         | 12      | 15 | 12 | 36           | 15 | 60 |
| BS5-121812-A   | 59          | 592.00     | --             | --          | --         | 5          | 12      | 18 | 12 | 12           | 18 | 60 |
| BS5-121812-C   | 147         | 1,331.00   | --             | --          | --         | 15         | 12      | 18 | 12 | 36           | 18 | 60 |
| BS5-151512-A   | 62          | 741.00     | --             | --          | --         | 5          | 15      | 15 | 12 | 15           | 15 | 60 |
| BS5-151512-C   | 156         | 1,548.00   | --             | --          | --         | 15         | 15      | 15 | 12 | 45           | 15 | 60 |
| BS5-151812-A   | 65          | 725.00     | --             | --          | --         | 5          | 15      | 18 | 12 | 15           | 18 | 60 |
| BS5-151812-C   | 162         | 1,593.00   | --             | --          | --         | 15         | 15      | 18 | 12 | 45           | 18 | 60 |

National Motor Freight Class: Welded, 175. Other sizes available. Call factory for pricing.

## 6-TIER BOX LOCKERS WITH LEGS



| WELDED†        |             |            | UNASSEMBLED    |             |            | DIMENSIONS |         |    |    |              |    |    |
|----------------|-------------|------------|----------------|-------------|------------|------------|---------|----|----|--------------|----|----|
| CATALOG NUMBER | UNIT WEIGHT | UNIT PRICE | CATALOG NUMBER | UNIT WEIGHT | UNIT PRICE | OPEN-INGS  | OPENING |    |    | OVERALL UNIT |    |    |
|                |             |            |                |             |            |            | W       | D  | H  | W            | D  | H  |
| BS6-121212-1▲  | 61          | \$634.00   | BK6-121212-1♣  | 60          | \$515.00   | 6          | 12      | 12 | 12 | 12           | 12 | 78 |
| BS6-121212-3▲  | 154         | 1,480.00   | BK6-121212-3♣  | 151         | 1,281.00   | 18         | 12      | 12 | 12 | 36           | 12 | 78 |
| BS6-121512-1▲  | 66          | 661.00     | BK6-121512-1♣  | 65          | 528.00     | 6          | 12      | 15 | 12 | 12           | 15 | 78 |
| BS6-121512-3▲  | 167         | 1,610.00   | BK6-121512-3♣  | 164         | 1,327.00   | 18         | 12      | 15 | 12 | 36           | 15 | 78 |
| BS6-121812-1▲  | 71          | 704.00     | BK6-121812-1♣  | 70          | 545.00     | 6          | 12      | 18 | 12 | 12           | 18 | 78 |
| BS6-121812-3▲  | 180         | 1,697.00   | BK6-121812-3♣  | 177         | 1,389.00   | 18         | 12      | 18 | 12 | 36           | 18 | 78 |
| BS6-151512-1   | 76          | 779.00     | BK6-151512-1   | 75          | 649.00     | 6          | 15      | 15 | 12 | 15           | 15 | 78 |
| BS6-151512-3   | 190         | 1,903.00   | BK6-151512-3   | 187         | 1,622.00   | 18         | 15      | 15 | 12 | 45           | 15 | 78 |
| BS6-151812-1♣  | 79          | 778.00     | BK6-151812-1   | 78          | 627.00     | 6          | 15      | 18 | 12 | 15           | 18 | 78 |
| BS6-151812-3♣  | 198         | 1,950.00   | BK6-151812-3   | 194         | 1,651.00   | 18         | 15      | 18 | 12 | 45           | 18 | 78 |

National Motor Freight Class: Welded, 175; Unassembled, 85. Other sizes available. Call factory for pricing.

## 6-TIER BOX LOCKERS WITHOUT LEGS



| WELDED†        |             |            | UNASSEMBLED    |             |            | DIMENSIONS |         |    |    |              |    |    |
|----------------|-------------|------------|----------------|-------------|------------|------------|---------|----|----|--------------|----|----|
| CATALOG NUMBER | UNIT WEIGHT | UNIT PRICE | CATALOG NUMBER | UNIT WEIGHT | UNIT PRICE | OPEN-INGS  | OPENING |    |    | OVERALL UNIT |    |    |
|                |             |            |                |             |            |            | W       | D  | H  | W            | D  | H  |
| BS6-121212-A♣  | 59          | \$617.00   | BK6-121212-A   | 58          | \$563.00   | 6          | 12      | 12 | 12 | 12           | 12 | 72 |
| BS6-121212-C♣  | 149         | 1,499.00   | BK6-121212-C   | 146         | 1,302.00   | 18         | 12      | 12 | 12 | 36           | 12 | 72 |
| BS6-121512-A   | 64          | 645.00     | BK6-121512-A   | 63          | 588.00     | 6          | 12      | 15 | 12 | 12           | 15 | 72 |
| BS6-121512-C   | 161         | 1,561.00   | BK6-121512-C   | 158         | 1,380.00   | 18         | 12      | 15 | 12 | 36           | 15 | 72 |
| BS6-121812-A▲  | 69          | 670.00     | BK6-121812-A   | 67          | 578.00     | 6          | 12      | 18 | 12 | 12           | 18 | 72 |
| BS6-121812-C▲  | 175         | 1,670.00   | BK6-121812-C   | 172         | 1,446.00   | 18         | 12      | 18 | 12 | 36           | 18 | 72 |
| BS6-151512-A   | 74          | 749.00     | BK6-151512-A   | 73          | 650.00     | 6          | 15      | 15 | 12 | 15           | 15 | 72 |
| BS6-151512-C   | 185         | 1,860.00   | BK6-151512-C   | 182         | 1,625.00   | 18         | 15      | 15 | 12 | 45           | 15 | 72 |
| BS6-151812-A   | 79          | 801.00     | BK6-151812-A   | 78          | 650.00     | 6          | 15      | 18 | 12 | 15           | 18 | 72 |
| BS6-151812-C   | 198         | 1,927.00   | BK6-151812-C   | 194         | 1,677.00   | 18         | 15      | 18 | 12 | 45           | 18 | 72 |

National Motor Freight Class: Welded, 175; Unassembled, 85. Other sizes available. Call factory for pricing.

### Standard Colors



▲ ♣  
Items with these symbols are available to ship in 2-3 days. Limited quantities and select colors.

▲ (SND) (MGY)  
♣ (MGY)

# Heavy-Duty Lockers

† Welded frames are riveted to welded locker body.

## WELDED† HEAVY-DUTY SINGLE TIER LOCKERS

| CATALOG NUMBER      | NO. OF COMPARTMENTS | OPENING |    |    | OVERALL UNIT |    |    | WEIGHT | PRICE           |
|---------------------|---------------------|---------|----|----|--------------|----|----|--------|-----------------|
|                     |                     | W       | D  | H  | W            | D  | H  |        |                 |
| <b>WITH LEGS</b>    |                     |         |    |    |              |    |    |        |                 |
| HSL-121872-1        | 1                   | 12      | 18 | 72 | 12           | 18 | 78 | 109    | <b>\$777.00</b> |
| HSL-121872-3        | 3                   | 12      | 18 | 72 | 36           | 18 | 78 | 280    | <b>1,836.00</b> |
| HSL-151872-1        | 1                   | 15      | 18 | 72 | 15           | 18 | 78 | 120    | <b>884.00</b>   |
| HSL-151872-3        | 3                   | 15      | 18 | 72 | 45           | 18 | 78 | 313    | <b>2,039.00</b> |
| HSL-181872-1        | 1                   | 18      | 18 | 72 | 18           | 18 | 78 | 144    | <b>910.00</b>   |
| HSL-181872-2        | 2                   | 18      | 18 | 72 | 36           | 18 | 78 | 263    | <b>1,489.00</b> |
| <b>WITHOUT LEGS</b> |                     |         |    |    |              |    |    |        |                 |
| HSL-121872-A        | 1                   | 12      | 18 | 72 | 12           | 18 | 72 | 107    | <b>\$820.00</b> |
| HSL-121872-C        | 3                   | 12      | 18 | 72 | 36           | 18 | 72 | 277    | <b>1,741.00</b> |
| HSL-151872-A        | 1                   | 15      | 18 | 72 | 15           | 18 | 72 | 119    | <b>813.00</b>   |
| HSL-151872-C        | 3                   | 15      | 18 | 72 | 45           | 18 | 72 | 311    | <b>2,020.00</b> |
| HSL-181872-A        | 1                   | 18      | 18 | 72 | 18           | 18 | 72 | 142    | <b>850.00</b>   |
| HSL-181872-B        | 2                   | 18      | 18 | 72 | 36           | 18 | 72 | 260    | <b>1,639.00</b> |



HSL-121872-C



HSL-121872-1

Locker body and shelf constructed of 16 gauge steel. Shipped assembled. National Motor Freight Class: 175

## WELDED† HEAVY-DUTY DOUBLE TIER LOCKERS

| CATALOG NUMBER      | NO. OF COMPARTMENTS | OPENING |    |    | OVERALL UNIT |    |    | WEIGHT | PRICE           |
|---------------------|---------------------|---------|----|----|--------------|----|----|--------|-----------------|
|                     |                     | W       | D  | H  | W            | D  | H  |        |                 |
| <b>WITH LEGS</b>    |                     |         |    |    |              |    |    |        |                 |
| HDL-121836-1        | 2                   | 12      | 18 | 36 | 12           | 18 | 78 | 111    | <b>\$926.00</b> |
| HDL-121836-3        | 6                   | 12      | 18 | 36 | 36           | 18 | 78 | 285    | <b>1,968.00</b> |
| HDL-151836-1        | 2                   | 15      | 18 | 36 | 15           | 18 | 78 | 135    | <b>948.00</b>   |
| HDL-151836-3        | 6                   | 15      | 18 | 36 | 45           | 18 | 78 | 331    | <b>2,263.00</b> |
| <b>WITHOUT LEGS</b> |                     |         |    |    |              |    |    |        |                 |
| HDL-121836-A        | 2                   | 12      | 18 | 36 | 12           | 18 | 72 | 109    | <b>\$884.00</b> |
| HDL-121836-C        | 6                   | 12      | 18 | 36 | 36           | 18 | 72 | 282    | <b>1,846.00</b> |
| HDL-151836-A        | 2                   | 15      | 18 | 36 | 15           | 18 | 72 | 133    | <b>932.00</b>   |
| HDL-151836-C        | 6                   | 15      | 18 | 36 | 45           | 18 | 72 | 327    | <b>1,961.00</b> |



HDL-121836-3



HDL-121836-A

Locker body and shelf constructed of 16 gauge steel. Shipped assembled. National Motor Freight Class: 175

## WELDED† HEAVY-DUTY 6-TIER BOX LOCKERS

| CATALOG NUMBER      | NO. OF COMPARTMENTS | OPENING |    |    | OVERALL UNIT |    |    | WEIGHT | PRICE             |
|---------------------|---------------------|---------|----|----|--------------|----|----|--------|-------------------|
|                     |                     | W       | D  | H  | W            | D  | H  |        |                   |
| <b>WITH LEGS</b>    |                     |         |    |    |              |    |    |        |                   |
| HBL6-1218-1         | 6                   | 12      | 18 | 12 | 12           | 18 | 78 | 126    | <b>\$1,122.00</b> |
| HBL6-1218-3         | 18                  | 12      | 18 | 12 | 36           | 18 | 78 | 332    | <b>2,377.00</b>   |
| <b>WITHOUT LEGS</b> |                     |         |    |    |              |    |    |        |                   |
| HBL6-1218-A         | 6                   | 12      | 18 | 12 | 12           | 18 | 72 | 124    | <b>\$1,044.00</b> |
| HBL6-1218-C         | 18                  | 12      | 18 | 12 | 36           | 18 | 72 | 328    | <b>2,354.00</b>   |



HBL6-1218-C



HBL6-1218-A

Locker body and shelf constructed of 16 gauge steel. Shipped assembled. National Motor Freight Class: 175

### Standard Colors



LOCKERS

# Specialty Lockers

†Welded frames are riveted to welded locker body.

## WELDED† COMBINATION LOCKERS



CMS-242172-A

| CATALOG NUMBER      | NO. OF COMPARTMENTS | OPENING |    |    | OVERALL UNIT |    |    | WEIGHT | PRICE             |
|---------------------|---------------------|---------|----|----|--------------|----|----|--------|-------------------|
|                     |                     | W       | D  | H  | W            | D  | H  |        |                   |
| <b>WITH LEGS</b>    |                     |         |    |    |              |    |    |        |                   |
| CMS-182172-1        | 7                   | 18      | 21 | 72 | 18           | 21 | 78 | 121    | <b>\$1,015.00</b> |
| CMS-242172-1♣       | 7                   | 24      | 21 | 72 | 24           | 21 | 78 | 126    | <b>1,125.00</b>   |
| <b>WITHOUT LEGS</b> |                     |         |    |    |              |    |    |        |                   |
| CMS-182172-A        | 7                   | 18      | 21 | 72 | 18           | 21 | 72 | 119    | <b>\$983.00</b>   |
| CMS-242172-A♣       | 7                   | 24      | 21 | 72 | 24           | 21 | 72 | 124    | <b>1,093.00</b>   |

Shipped assembled.  
National Motor Freight Class: 175

## WELDED† HALF-HEIGHT LOCKERS



STS-121836-A

| CATALOG NUMBER      | NO. OF COMPARTMENTS | OPENING |    |    | OVERALL UNIT |    |    | WEIGHT | PRICE           |
|---------------------|---------------------|---------|----|----|--------------|----|----|--------|-----------------|
|                     |                     | W       | D  | H  | W            | D  | H  |        |                 |
| <b>WITH LEGS</b>    |                     |         |    |    |              |    |    |        |                 |
| STS-121236-1        | 1                   | 12      | 12 | 36 | 12           | 12 | 42 | 37     | <b>\$418.00</b> |
| STS-121836-1        | 1                   | 12      | 18 | 36 | 12           | 18 | 42 | 42     | <b>475.00</b>   |
| <b>WITHOUT LEGS</b> |                     |         |    |    |              |    |    |        |                 |
| STS-121236-A        | 1                   | 12      | 12 | 36 | 12           | 12 | 36 | 35     | <b>\$412.00</b> |
| STS-121836-A        | 1                   | 12      | 18 | 36 | 12           | 18 | 36 | 40     | <b>454.00</b>   |

Shipped assembled.  
National Motor Freight Class: 175

## WELDED† WALL MOUNTED LOCKERS



BS1-121812-3



BS1-121812-4

| CATALOG NUMBER         | NO. OF COMPARTMENTS | OPENING |    |    | OVERALL UNIT |    |    | WEIGHT | PRICE           |
|------------------------|---------------------|---------|----|----|--------------|----|----|--------|-----------------|
|                        |                     | W       | D  | H  | W            | D  | H  |        |                 |
| <b>3-PERSON LOCKER</b> |                     |         |    |    |              |    |    |        |                 |
| BS1-121812-3*♣         | 3                   | 12      | 18 | 12 | 36           | 18 | 12 | 43     | <b>\$604.00</b> |
| <b>4-PERSON LOCKER</b> |                     |         |    |    |              |    |    |        |                 |
| BS1-121812-4*♣         | 4                   | 12      | 18 | 12 | 48           | 18 | 12 | 55     | <b>660.00</b>   |

\*Wall mounted lockers are shipped assembled only. Coat rods are installed in field.  
Coat rod and brackets included with all 3-person and 4-person lockers.  
National Motor Freight Class: 175

## WELDED† WALL MOUNTED C-THRU LOCKERS



CBS1-121812-4

| CATALOG NUMBER         | NO. OF COMPARTMENTS | OPENING |    |    | OVERALL UNIT |    |    | WEIGHT | PRICE           |
|------------------------|---------------------|---------|----|----|--------------|----|----|--------|-----------------|
|                        |                     | W       | D  | H  | W            | D  | H  |        |                 |
| <b>4-PERSON LOCKER</b> |                     |         |    |    |              |    |    |        |                 |
| CBS1-121812-4*         | 4                   | 12      | 18 | 12 | 48           | 18 | 12 | 53     | <b>\$738.00</b> |

\*Shipped assembled. Coat rod and brackets included. Coat rods are installed in field.  
National Motor Freight Class: 175

### Standard Colors



Items with this symbol are available to ship in 2-3 days. Limited quantities and select colors.



# 15 & 16 Person Lockers

† Welded frames are riveted to welded locker body.

## 15 PERSON LOCKERS

| CATALOG NUMBER                  | NO. OF COMPARTMENTS | OPENING |    |    | OVERALL UNIT |    |    | WEIGHT | PRICE             |
|---------------------------------|---------------------|---------|----|----|--------------|----|----|--------|-------------------|
|                                 |                     | W       | D  | H  | W            | D  | H  |        |                   |
| <b>WELDED† WITH LEGS</b>        |                     |         |    |    |              |    |    |        |                   |
| SRS-601878-1*                   | 15                  | 12      | 18 | 12 | 60           | 18 | 78 | 182    | <b>\$1,855.00</b> |
| <b>UNASSEMBLED WITH LEGS</b>    |                     |         |    |    |              |    |    |        |                   |
| SRK-601878-1                    | 15                  | 12      | 18 | 12 | 60           | 18 | 78 | 179    | <b>1,545.00</b>   |
| <b>WELDED† WITHOUT LEGS</b>     |                     |         |    |    |              |    |    |        |                   |
| SRS-601872-A*                   | 15                  | 12      | 18 | 12 | 60           | 18 | 72 | 180    | <b>1,835.00</b>   |
| <b>UNASSEMBLED WITHOUT LEGS</b> |                     |         |    |    |              |    |    |        |                   |
| SRK-601872-A                    | 15                  | 12      | 18 | 12 | 60           | 18 | 72 | 177    | <b>1,527.00</b>   |



SRS-601878-1

\*Shipped assembled. Coat rod and brackets included. Center section and coat rods are installed in field.  
National Motor Freight Class: Assembled, 175; Unassembled, 85

## 16 PERSON LOCKERS

| CATALOG NUMBER                  | NO. OF COMPARTMENTS | OPENING |    |    | OVERALL UNIT |    |    | WEIGHT | PRICE             |
|---------------------------------|---------------------|---------|----|----|--------------|----|----|--------|-------------------|
|                                 |                     | W       | D  | H  | W            | D  | H  |        |                   |
| <b>WELDED† WITH LEGS</b>        |                     |         |    |    |              |    |    |        |                   |
| SRS-721878-1*♣                  | 16                  | 12      | 18 | 12 | 72           | 18 | 78 | 190    | <b>\$1,952.00</b> |
| <b>UNASSEMBLED WITH LEGS</b>    |                     |         |    |    |              |    |    |        |                   |
| SRK-721878-1♣                   | 16                  | 12      | 18 | 12 | 72           | 18 | 78 | 187    | <b>1,537.00</b>   |
| <b>WELDED† WITHOUT LEGS</b>     |                     |         |    |    |              |    |    |        |                   |
| SRS-721872-A*♣                  | 16                  | 12      | 18 | 12 | 72           | 18 | 72 | 184    | <b>1,946.00</b>   |
| <b>UNASSEMBLED WITHOUT LEGS</b> |                     |         |    |    |              |    |    |        |                   |
| SRK-721872-A                    | 16                  | 12      | 18 | 12 | 72           | 18 | 72 | 181    | <b>1,659.00</b>   |



SRS-721878-1

\*Shipped assembled. Coat rod and brackets included. Center section and coat rods are installed in field.  
National Motor Freight Class: Assembled, 175; Unassembled, 85

## 16 PERSON LOCKER WITH C-THRU DOORS

| CATALOG NUMBER                | NO. OF COMPARTMENTS | OPENING |    |    | OVERALL UNIT |    |    | WEIGHT | PRICE             |
|-------------------------------|---------------------|---------|----|----|--------------|----|----|--------|-------------------|
|                               |                     | W       | D  | H  | W            | D  | H  |        |                   |
| <b>ASSEMBLED WITH LEGS</b>    |                     |         |    |    |              |    |    |        |                   |
| CSRS-721878-1*                | 16                  | 12      | 18 | 12 | 72           | 18 | 78 | 180    | <b>\$2,088.00</b> |
| <b>ASSEMBLED WITHOUT LEGS</b> |                     |         |    |    |              |    |    |        |                   |
| CSRS-721872-A*                | 16                  | 12      | 18 | 12 | 72           | 18 | 72 | 175    | <b>2,052.00</b>   |



CSRS-721872-A

\*Shipped assembled. Coat rod and brackets included. Center section and coat rods are installed in field.  
National Motor Freight Class: Assembled, 175

### Standard Colors



♣ Items with this symbol are available to ship in 2-3 days. Limited quantities and select colors.



LOCKERS

# C-Thru Lockers

† Welded frames are riveted to welded locker body.

## WELDED† SINGLE TIER C-THRU LOCKERS



CSL-121872-3

CSL-121872-1

Shipped assembled.  
National Motor Freight Class: 175

| CATALOG NUMBER      | NO. OF COMPARTMENTS | OPENING |    |    | OVERALL UNIT |    |    | WEIGHT | PRICE             |
|---------------------|---------------------|---------|----|----|--------------|----|----|--------|-------------------|
|                     |                     | W       | D  | H  | W            | D  | H  |        |                   |
| <b>WITH LEGS</b>    |                     |         |    |    |              |    |    |        |                   |
| CSL-121272-1        | 1                   | 12      | 12 | 72 | 12           | 12 | 78 | 61     | <b>\$808.00</b>   |
| CSL-121272-3        | 3                   | 12      | 12 | 72 | 36           | 12 | 78 | 156    | <b>1,990.00</b>   |
| CSL-121572-1        | 1                   | 12      | 15 | 72 | 12           | 15 | 78 | 65     | <b>811.00</b>     |
| CSL-121572-3        | 3                   | 12      | 15 | 72 | 36           | 15 | 78 | 164    | <b>2,032.00</b>   |
| CSL-121872-1        | 1                   | 12      | 18 | 72 | 12           | 18 | 78 | 69     | <b>828.00</b>     |
| CSL-121872-3        | 3                   | 12      | 18 | 72 | 36           | 18 | 78 | 173    | <b>2,088.00</b>   |
| CSL-151872-1        | 1                   | 15      | 18 | 72 | 15           | 18 | 78 | 96     | <b>849.00</b>     |
| CSL-151872-3        | 3                   | 15      | 18 | 72 | 45           | 18 | 78 | 196    | <b>2,092.00</b>   |
| <b>WITHOUT LEGS</b> |                     |         |    |    |              |    |    |        |                   |
| CSL-121572-C        | 3                   | 12      | 15 | 72 | 36           | 15 | 72 | 159    | <b>\$2,014.00</b> |
| CSL-121872-A        | 1                   | 12      | 18 | 72 | 12           | 18 | 72 | 67     | <b>881.00</b>     |
| CSL-121872-C        | 3                   | 12      | 18 | 72 | 36           | 18 | 72 | 168    | <b>2,059.00</b>   |
| CSL-151872-A        | 1                   | 15      | 18 | 72 | 15           | 18 | 72 | 74     | <b>831.00</b>     |
| CSL-151872-C        | 3                   | 15      | 18 | 72 | 45           | 18 | 72 | 191    | <b>2,029.00</b>   |

## WELDED† DOUBLE TIER C-THRU LOCKERS



CDL-121836-3

CDL-121836-1

Shipped assembled.  
National Motor Freight Class: 175

| CATALOG NUMBER      | NO. OF COMPARTMENTS | OPENING |    |    | OVERALL UNIT |    |    | WEIGHT | PRICE           |
|---------------------|---------------------|---------|----|----|--------------|----|----|--------|-----------------|
|                     |                     | W       | D  | H  | W            | D  | H  |        |                 |
| <b>WITH LEGS</b>    |                     |         |    |    |              |    |    |        |                 |
| CDL-121236-1        | 2                   | 12      | 12 | 36 | 12           | 12 | 78 | 59     | <b>\$787.00</b> |
| CDL-121236-3        | 6                   | 12      | 12 | 36 | 36           | 12 | 78 | 151    | <b>2,194.00</b> |
| CDL-121536-1        | 2                   | 12      | 15 | 36 | 12           | 15 | 78 | 63     | <b>874.00</b>   |
| CDL-121536-3        | 6                   | 12      | 15 | 36 | 36           | 15 | 78 | 159    | <b>2,248.00</b> |
| CDL-121836-1        | 2                   | 12      | 18 | 36 | 12           | 18 | 78 | 67     | <b>1,031.00</b> |
| CDL-121836-3        | 6                   | 12      | 18 | 36 | 36           | 18 | 78 | 168    | <b>2,234.00</b> |
| CDL-151836-1        | 2                   | 15      | 18 | 36 | 15           | 18 | 78 | 74     | <b>929.00</b>   |
| CDL-151836-3        | 6                   | 15      | 18 | 36 | 45           | 18 | 78 | 191    | <b>2,539.00</b> |
| <b>WITHOUT LEGS</b> |                     |         |    |    |              |    |    |        |                 |
| CDL-121236-A        | 2                   | 12      | 12 | 36 | 12           | 12 | 72 | 57     | <b>\$925.00</b> |
| CDL-121236-C        | 6                   | 12      | 12 | 36 | 36           | 12 | 72 | 146    | <b>2,184.00</b> |
| CDL-121536-C        | 6                   | 12      | 15 | 36 | 36           | 15 | 72 | 154    | <b>2,137.00</b> |
| CDL-121836-A        | 2                   | 12      | 18 | 36 | 12           | 18 | 72 | 65     | <b>948.00</b>   |
| CDL-121836-C        | 6                   | 12      | 18 | 36 | 36           | 18 | 72 | 163    | <b>2,234.00</b> |
| CDL-151836-C        | 6                   | 15      | 18 | 36 | 45           | 18 | 72 | 183    | <b>2,538.00</b> |

## WELDED† 6-TIER C-THRU BOX LOCKERS



CBL6-121812-3

CBL6-121812-A

Shipped assembled.  
National Motor Freight Class: 175

| CATALOG NUMBER      | NO. OF COMPARTMENTS | OPENING |    |    | OVERALL UNIT |    |    | WEIGHT | PRICE           |
|---------------------|---------------------|---------|----|----|--------------|----|----|--------|-----------------|
|                     |                     | W       | D  | H  | W            | D  | H  |        |                 |
| <b>WITH LEGS</b>    |                     |         |    |    |              |    |    |        |                 |
| CBL6-121212-1       | 6                   | 12      | 12 | 12 | 12           | 12 | 78 | 53     | <b>\$664.00</b> |
| CBL6-121212-3       | 18                  | 12      | 12 | 12 | 36           | 12 | 78 | 131    | <b>1,765.00</b> |
| CBL6-121512-1       | 6                   | 12      | 15 | 12 | 12           | 15 | 78 | 58     | <b>719.00</b>   |
| CBL6-121512-3       | 18                  | 12      | 15 | 12 | 36           | 15 | 78 | 145    | <b>1,769.00</b> |
| CBL6-121812-1       | 6                   | 12      | 18 | 12 | 12           | 18 | 78 | 63     | <b>710.00</b>   |
| CBL6-121812-3       | 18                  | 12      | 18 | 12 | 36           | 18 | 78 | 157    | <b>1,810.00</b> |
| <b>WITHOUT LEGS</b> |                     |         |    |    |              |    |    |        |                 |
| CBL6-121212-A       | 6                   | 12      | 12 | 12 | 12           | 12 | 72 | 51     | <b>\$660.00</b> |
| CBL6-121212-C       | 18                  | 12      | 12 | 12 | 36           | 12 | 72 | 126    | <b>1,708.00</b> |
| CBL6-121512-A       | 6                   | 12      | 15 | 12 | 12           | 15 | 72 | 56     | <b>745.00</b>   |
| CBL6-121512-C       | 18                  | 12      | 15 | 12 | 36           | 15 | 72 | 140    | <b>1,779.00</b> |
| CBL6-121812-A       | 6                   | 12      | 18 | 12 | 12           | 18 | 72 | 61     | <b>777.00</b>   |
| CBL6-121812-C       | 18                  | 12      | 18 | 12 | 36           | 18 | 72 | 152    | <b>1,851.00</b> |

### Standard Colors





# Heavy-Duty Ventilated Lockers

† Welded frames are riveted to welded locker body.

## WELDED VENTILATED SINGLE TIER LOCKERS

| CATALOG NUMBER      | NO. OF COMPARTMENTS | OPENING |    |    | OVERALL UNIT |    |    | WEIGHT | PRICE           |
|---------------------|---------------------|---------|----|----|--------------|----|----|--------|-----------------|
|                     |                     | W       | D  | H  | W            | D  | H  |        |                 |
| <b>WITH LEGS</b>    |                     |         |    |    |              |    |    |        |                 |
| VSL-121872-1        | 1                   | 12      | 18 | 72 | 12           | 18 | 78 | 88     | <b>\$839.00</b> |
| VSL-121872-3♣       | 3                   | 12      | 18 | 72 | 36           | 18 | 78 | 219    | <b>1,958.00</b> |
| VSL-151872-1        | 1                   | 15      | 18 | 72 | 15           | 18 | 78 | 93     | <b>944.00</b>   |
| VSL-151872-3        | 3                   | 15      | 18 | 72 | 45           | 18 | 78 | 233    | <b>2,210.00</b> |
| VSL-181872-1        | 1                   | 18      | 18 | 72 | 18           | 18 | 78 | 98     | <b>982.00</b>   |
| VSL-181872-2        | 2                   | 18      | 18 | 72 | 36           | 18 | 78 | 245    | <b>1,818.00</b> |
| <b>WITHOUT LEGS</b> |                     |         |    |    |              |    |    |        |                 |
| VSL-121872-A        | 1                   | 12      | 18 | 72 | 12           | 18 | 72 | 86     | <b>\$870.00</b> |
| VSL-121872-C        | 3                   | 12      | 18 | 72 | 36           | 18 | 72 | 214    | <b>1,907.00</b> |
| VSL-151872-A        | 1                   | 15      | 18 | 72 | 15           | 18 | 72 | 91     | <b>899.00</b>   |
| VSL-151872-C        | 3                   | 15      | 18 | 72 | 45           | 18 | 72 | 228    | <b>2,226.00</b> |
| VSL-181872-A        | 1                   | 18      | 18 | 72 | 18           | 18 | 72 | 96     | <b>972.00</b>   |
| VSL-181872-B        | 2                   | 18      | 18 | 72 | 36           | 18 | 72 | 241    | <b>1,806.00</b> |

Shipped assembled.

National Motor Freight Class: 175



VSL-121872-1

VSL-121872-3

## WELDED VENTILATED DOUBLE TIER LOCKERS

| CATALOG NUMBER      | NO. OF COMPARTMENTS | OPENING |    |    | OVERALL UNIT |    |    | WEIGHT | PRICE           |
|---------------------|---------------------|---------|----|----|--------------|----|----|--------|-----------------|
|                     |                     | W       | D  | H  | W            | D  | H  |        |                 |
| <b>WITH LEGS</b>    |                     |         |    |    |              |    |    |        |                 |
| VDL-121836-1        | 2                   | 12      | 18 | 36 | 12           | 18 | 78 | 88     | <b>\$895.00</b> |
| VDL-121836-3♣       | 6                   | 12      | 18 | 36 | 36           | 18 | 78 | 223    | <b>2,119.00</b> |
| VDL-151836-1        | 2                   | 15      | 18 | 36 | 15           | 18 | 78 | 93     | <b>991.00</b>   |
| VDL-151836-3        | 6                   | 15      | 18 | 36 | 45           | 18 | 78 | 233    | <b>2,464.00</b> |
| <b>WITHOUT LEGS</b> |                     |         |    |    |              |    |    |        |                 |
| VDL-121836-A        | 2                   | 12      | 18 | 36 | 12           | 18 | 72 | 84     | <b>\$906.00</b> |
| VDL-121836-C        | 6                   | 12      | 18 | 36 | 36           | 18 | 72 | 209    | <b>2,069.00</b> |
| VDL-151836-A        | 2                   | 15      | 18 | 36 | 15           | 18 | 72 | 89     | <b>1,004.00</b> |
| VDL-151836-C        | 6                   | 15      | 18 | 36 | 45           | 18 | 72 | 223    | <b>2,415.00</b> |

Shipped assembled.

National Motor Freight Class: 175



VDL-121836-1

VDL-121836-3

LOCKERS

## WELDED VENTILATED 6-TIER BOX LOCKERS

| CATALOG NUMBER      | NO. OF COMPARTMENTS | OPENING |    |    | OVERALL UNIT |    |    | WEIGHT | PRICE             |
|---------------------|---------------------|---------|----|----|--------------|----|----|--------|-------------------|
|                     |                     | W       | D  | H  | W            | D  | H  |        |                   |
| <b>WITH LEGS</b>    |                     |         |    |    |              |    |    |        |                   |
| VBL6-1218-1♣        | 6                   | 12      | 18 | 12 | 12           | 18 | 78 | 104    | <b>\$1,000.00</b> |
| VBL6-1218-3♣        | 18                  | 12      | 18 | 12 | 36           | 18 | 78 | 274    | <b>2,477.00</b>   |
| <b>WITHOUT LEGS</b> |                     |         |    |    |              |    |    |        |                   |
| VBL6-1218-A         | 6                   | 12      | 18 | 12 | 12           | 18 | 72 | 102    | <b>\$990.00</b>   |
| VBL6-1218-C         | 18                  | 12      | 18 | 12 | 36           | 18 | 72 | 270    | <b>2,432.00</b>   |

Shipped assembled.

National Motor Freight Class: 175



VBL6-1218-1

VBL6-1218-3

### Standard Colors



♣ Items with this symbol are available to ship in 2-3 days. Limited quantities and select colors.



## COST FOR PERFORATION ON DOORS

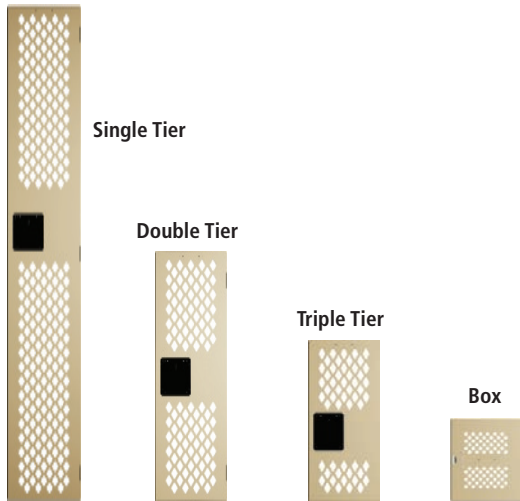

| CAT. NO. | DESCRIPTION               | PERFORATION COST* |
|----------|---------------------------|-------------------|
| LPDS-12  | SINGLE TIER DOOR 12" WIDE | \$35.00           |
| LPDS-15  | SINGLE TIER DOOR 15" WIDE | 35.00             |
| LPDD-12  | DOUBLE TIER DOOR 12" WIDE | 35.00             |
| LPDD-15  | DOUBLE TIER DOOR 15" WIDE | 35.00             |
| LPDT-12  | TRIPLE TIER DOOR 12" WIDE | 35.00             |
| LPDT-15  | TRIPLE TIER DOOR 15" WIDE | 35.00             |
| LPDB-12  | BOX DOOR 12" WIDE         | 35.00             |
| LPDB-15  | BOX DOOR 15" WIDE         | 35.00             |

\*Cost listed is the additional cost for the door to be perforated. Lockers or Doors must be ordered separately. Perforation is available on select lockers with solid doors. For sizes not listed, call factory for pricing and availability.

National Motor Freight Class: 85

## REPLACEMENT DOORS

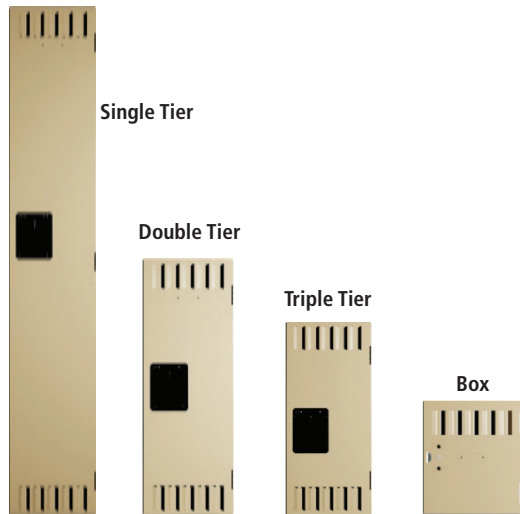

| CAT. NO.  | DOOR TYPE   | W  | H  | WT.  | PRICE    |
|-----------|-------------|----|----|------|----------|
| LSTD-1260 | SINGLE TIER | 12 | 60 | 20.0 | \$257.00 |
| LSTD-1560 | SINGLE TIER | 15 | 60 | 23.0 | 268.00   |
| LSTD-1272 | SINGLE TIER | 12 | 72 | 23.0 | 216.00   |
| LSTD-1572 | SINGLE TIER | 15 | 72 | 27.0 | 258.00   |
| LSTD-1872 | SINGLE TIER | 18 | 72 | 31.0 | 287.00   |
| LDTD-1230 | DOUBLE TIER | 12 | 30 | 9.3  | 122.00   |
| LDTD-1236 | DOUBLE TIER | 12 | 36 | 11.0 | 125.00   |
| LDTD-1536 | DOUBLE TIER | 15 | 36 | 12.8 | 144.00   |
| LTTD-1224 | TRIPLE TIER | 12 | 24 | 5.0  | 124.00   |
| LBD-1212  | BOX         | 12 | 12 | 3.1  | 22.00    |
| LBD-1512  | BOX         | 15 | 12 | 3.6  | 61.00    |

Lockbar and recessed cup included.

National Motor Freight Class: 85

## REPLACEMENT DOOR FRAME ASSEMBLIES

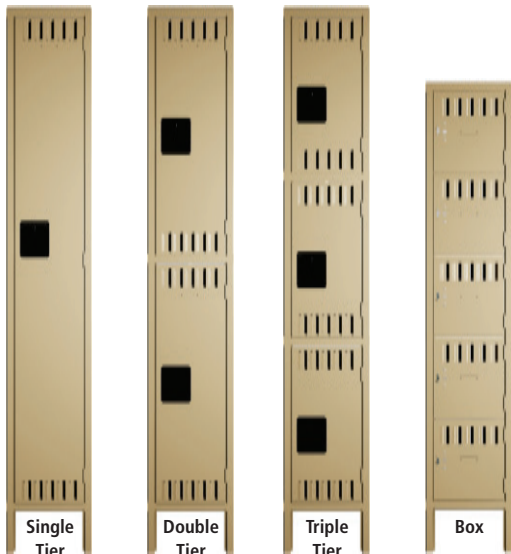

| CAT. NO.  | DOOR TYPE   | W  | H  | WT.  | PRICE    |
|-----------|-------------|----|----|------|----------|
| LSFA-1260 | SINGLE TIER | 12 | 60 | 35.0 | \$337.00 |
| LSFA-1560 | SINGLE TIER | 15 | 60 | 34.0 | 350.00   |
| LSFA-1272 | SINGLE TIER | 12 | 72 | 36.0 | 329.00   |
| LSFA-1572 | SINGLE TIER | 15 | 72 | 40.0 | 340.00   |
| LSFA-1872 | SINGLE TIER | 18 | 72 | 45.0 | 377.00   |
| LSFA-2472 | SINGLE TIER | 24 | 72 | 60.0 | 514.00   |
| LDFA-1260 | DOUBLE TIER | 12 | 60 | 34.0 | 340.00   |
| LDFA-1272 | DOUBLE TIER | 12 | 72 | 37.0 | 358.00   |
| LDFA-1572 | DOUBLE TIER | 15 | 72 | 42.0 | 390.00   |
| LTFA-1272 | TRIPLE TIER | 12 | 72 | 35.0 | 496.00   |
| LTFA-1572 | TRIPLE TIER | 12 | 72 | 38.0 | 532.00   |
| LBFA-1260 | BOX         | 12 | 60 | 29.0 | 268.00   |
| LBFA-1272 | BOX         | 12 | 72 | 24.0 | 298.00   |

Lockbar and recessed cup included.

Catalog numbers shown are for frames without legs. For frames with legs, add the suffix "-1".

National Motor Freight Class: 85

### Standard Colors



Sand (SND) Champagne/ Putty (CPY) Light Grey (LGY) Medium Grey (MGY) Black (BLK)

## FRONT AND END BASES

| FRONT BASES |    |   |   |     |        |
|-------------|----|---|---|-----|--------|
| CAT. NO.    | W  | D | H | WT. | PRICE  |
| FB-12 ▲     | 12 | — | 6 | 1.2 | \$9.50 |
| FB-15 ▲     | 15 | — | 6 | 1.7 | 10.30  |
| FB-18 ▲     | 18 | — | 6 | 2.0 | 12.20  |
| FB-24       | 24 | — | 6 | 2.8 | 20.00  |

| END BASES |   |    |   |     |         |
|-----------|---|----|---|-----|---------|
| CAT. NO.  | W | D  | H | WT. | PRICE   |
| EB-12 ▲   | — | 12 | 6 | 1.2 | \$15.50 |
| EB-15 ▲   | — | 15 | 6 | 1.4 | 16.90   |
| EB-18 ▲   | — | 18 | 6 | 1.7 | 17.00   |
| EB-21     | — | 21 | 6 | 2.4 | 33.00   |
| EB-24     | — | 24 | 6 | 2.6 | 33.00   |



National Motor Freight Class: 85

## CLOSED BASES

| ONE-WIDE BASES |    |    |   |      |         |
|----------------|----|----|---|------|---------|
| CAT. NO.       | W  | D  | H | WT.  | PRICE   |
| CLB-1212       | 12 | 12 | 6 | 7.4  | \$63.00 |
| CLB-1215       | 12 | 15 | 6 | 7.3  | 68.00   |
| CLB-1218 ▲     | 12 | 18 | 6 | 7.7  | 65.00   |
| CLB-1518 ▲     | 15 | 18 | 6 | 8.5  | 80.00   |
| CLB-1521       | 15 | 21 | 6 | 11.0 | 91.00   |

| THREE-WIDE BASES |    |    |   |      |          |
|------------------|----|----|---|------|----------|
| CAT. NO.         | W  | D  | H | WT.  | PRICE    |
| CLB-3612 ▲       | 36 | 12 | 6 | 13.1 | \$126.00 |
| CLB-3615 ▲       | 36 | 15 | 6 | 16.3 | 132.00   |
| CLB-3618 ▲       | 36 | 18 | 6 | 19.6 | 128.00   |
| CLB-4512         | 45 | 12 | 6 | 16.3 | 144.00   |
| CLB-4515         | 45 | 15 | 6 | 20.4 | 151.00   |
| CLB-4518         | 45 | 18 | 6 | 17.0 | 154.00   |



National Motor Freight Class: 85

| CAT. NO.            | W     | D     | H     | WT.  | PRICE   |
|---------------------|-------|-------|-------|------|---------|
| <b>Z-BASE FRONT</b> |       |       |       |      |         |
| LZBA-12             | 12    | 1 5/8 | 4     | 1.7  | \$31.00 |
| LZBA-36             | 36    | 1 5/8 | 4     | 5.5  | 46.00   |
| LZBA-72             | 72    | 1 5/8 | 4     | 12.0 | 71.00   |
| <b>Z-BASE SIDE</b>  |       |       |       |      |         |
| LZBS-18             | —     | 18    | 4     | 4.8  | \$23.00 |
| <b>SPLICE PLATE</b> |       |       |       |      |         |
| LZBSPL              | 3 1/2 | —     | 3 3/4 | 0.8  | \$3.90  |

NOTE: Z-Base only supports front of locker, creating a 4" space beneath the locker. Locker must be anchored to a wall or back-to-back.

National Motor Freight Class: 85



## Z-BASES

The shape of the Z-Base provides a recessed front base and toe-plate.

| CAT. NO.                 | W   | D     | H      | WT.  | PRICE    |
|--------------------------|-----|-------|--------|------|----------|
| HMLB-36                  | 36  | 9 1/2 | 1 1/4  | 10.0 | \$186.00 |
| HMLB-48                  | 48  | 9 1/2 | 1 1/4  | 16.0 | 237.00   |
| HMLB-60                  | 60  | 9 1/2 | 1 1/4  | 20.0 | 279.00   |
| HMLB-72                  | 72  | 9 1/2 | 1 1/4  | 20.0 | 340.00   |
| HMLB-84                  | 84  | 9 1/2 | 1 1/4  | 28.0 | 390.00   |
| HMLB-96                  | 96  | 9 1/2 | 1 1/4  | 32.0 | 457.00   |
| HMLB-108*                | 108 | 9 1/2 | 1 1/4  | 36.0 | 518.00   |
| HMLB-120*                | 120 | 9 1/2 | 1 1/4  | 40.0 | 583.00   |
| HMLB-144*                | 144 | 9 1/2 | 1 1/4  | 48.0 | 725.00   |
| LBP-1 (BENCH PEDESTAL) ▲ |     |       | 16 1/4 | 7.0  | \$72.00  |

Color options not available for HMLB-ww.

National Motor Freight Class: 85

## LAMINATE HARD MAPLE BENCHES & BENCH PEDESTALS



NOTE: Pedestals must be ordered separately.

\*Use three pedestals for benches 108" to 144".

| CAT. NO. | W  | D  | H   | WT. | PRICE   |
|----------|----|----|-----|-----|---------|
| ESL-1212 | 12 | 12 | 3/4 | 1.3 | \$33.00 |
| ESL-1215 | 12 | 15 | 3/4 | 1.9 | 33.00   |
| ESL-1218 | 12 | 18 | 3/4 | 2.2 | 37.00   |
| ESL-1518 | 15 | 18 | 3/4 | 2.4 | 37.00   |
| ESL-1521 | 15 | 21 | 3/4 | 3.3 | 56.00   |
| ESL-1821 | 18 | 21 | 3/4 | 3.8 | 58.00   |
| ESL-2424 | 24 | 24 | 3/4 | 4.6 | 57.00   |

National Motor Freight Class: 85

## SHELVES FOR STANDARD LOCKERS



### Standard Colors



▲ Items with this symbol are available to ship in 2-3 days. Limited quantities and select colors.



# Locker Accessories

## COAT RODS & COAT HOOKS



\*Coat rods are available in Medium Grey only.  
\*\*Double Coat Hook can not be used with coat rod.  
Double Coat Hooks are available in Chrome only.

| CAT. NO.          | W                  | D | H | WT. | PRICE          |
|-------------------|--------------------|---|---|-----|----------------|
| <b>COAT RODS*</b> |                    |   |   |     |                |
| LCR-12            | 12                 | — | — | 0.4 | <b>\$23.00</b> |
| LCR-15            | 15                 | — | — | 0.4 | <b>26.00</b>   |
| LCR-18            | 18                 | — | — | 0.5 | <b>31.00</b>   |
| LCR-21            | 21                 | — | — | 0.6 | <b>35.00</b>   |
| LCR-24            | 24                 | — | — | 0.7 | <b>35.00</b>   |
| <b>COAT HOOKS</b> |                    |   |   |     |                |
| LCH-1             | SINGLE COAT HOOK   |   |   | 0.1 | <b>\$3.50</b>  |
| LCH-2             | DOUBLE COAT HOOK** |   |   | 0.2 | <b>5.20</b>    |

National Motor Freight Class: 85

## LOCKING CHANNELS



Locking Channels are a vertical product, but shown horizontal for clarity of detail. Available in Medium Grey only.

| CAT. NO. | DESCRIPTION     | WT. | PRICE          |
|----------|-----------------|-----|----------------|
| LLCA-1   | FOR SINGLE TIER | 1.0 | <b>\$15.90</b> |
| LLCA-2   | FOR DOUBLE TIER | 0.5 | <b>13.20</b>   |
| LLCA-3   | FOR TRIPLE TIER | 0.4 | <b>12.50</b>   |

National Motor Freight Class: 85

## RECESSED HANDLES



| CAT. NO. | DESCRIPTION     | WT. | PRICE          |
|----------|-----------------|-----|----------------|
| LRH-2    | PAINTED STEEL   | 0.7 | <b>\$10.50</b> |
| LRH-3    | STAINLESS STEEL | 0.7 | <b>22.00</b>   |

Color options not available.

National Motor Freight Class: 85

## MISCELLANEOUS REPLACEMENT PARTS

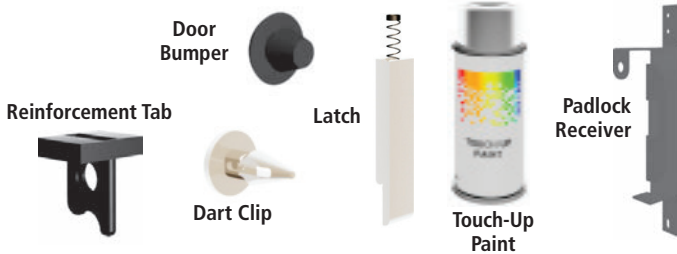

| CAT. NO. | DESCRIPTION       | WT. | PRICE         |
|----------|-------------------|-----|---------------|
| LL-3     | LATCH AND SPRING  | 0.1 | <b>\$2.30</b> |
| LPR-2    | PADLOCK RECEIVER  | 0.3 | <b>5.40</b>   |
| LB-1     | DOOR BUMPER       | 0.1 | <b>2.40</b>   |
| LDC-1    | DART CLIP         | 0.1 | <b>2.50</b>   |
| LRT-1    | REINFORCEMENT TAB | 0.2 | <b>3.50</b>   |
| LTUP-1   | TOUCH-UP PAINT    | 0.3 | <b>19.80</b>  |

Color options not available, except for Touch-Up Paint.

National Motor Freight Class: 85

## LOCKS BY MASTER LOCK

All locks can be used on any Tennsco locker except where noted.

### GROOVED KEY LOCK



### COMBINATION LOCKS



DEAD BOLT    SPRING BOLT    GRAVITY LIFT

### COMBINATION PADLOCKS



MASTER KEYED    NO KEY

### KEYS



| CAT. NO.                    | DESCRIPTION                      | WT. | PRICE*         |
|-----------------------------|----------------------------------|-----|----------------|
| <b>GROOVED KEY LOCK</b>     |                                  |     |                |
| MAS-1710MK                  | GROOVED KEY LOCK (DEAD BOLT)     | 0.4 | <b>\$65.00</b> |
| <b>COMBINATION LOCKS</b>    |                                  |     |                |
| MAS-1670                    | DEAD BOLT (MASTER KEYED)         | 0.5 | <b>\$78.00</b> |
| MAS-1654                    | SPRING BOLT (MASTER KEYED)       | 0.5 | <b>76.00</b>   |
| MAS-1630*                   | GRAVITY LIFT LOCK (MASTER KEYED) | 0.5 | <b>68.00</b>   |
| <b>COMBINATION PADLOCKS</b> |                                  |     |                |
| MAS-1525                    | COMBINATION (MASTER KEYED)       | 0.5 | <b>\$35.00</b> |
| MAS-1502                    | COMBINATION (NO KEY)             | 0.5 | <b>27.00</b>   |

Master keyed locks are shipped with two master keys per order. To order additional master keys, see "Keys" (below).

\*NOTE: Gravity Lift Locks do not work on box lockers.

Color options not available.

| CAT. NO. | KEY TYPE                                | FITS LOCK TYPE      | PRICE*         |
|----------|---|---------------------|----------------|
| LMCK-1   | MASTER KEY (FITS ALL LOCKS IN A SERIES) | COMBINATION LOCK    | <b>\$25.00</b> |
| LMPK-1   | MASTER KEY (FITS ALL LOCKS IN A SERIES) | COMBINATION PADLOCK | <b>29.00</b>   |
| LMGK-1   | MASTER KEY (FITS ALL LOCKS IN A SERIES) | GROOVED KEY         | <b>55.00</b>   |

National Motor Freight Class: 85

Color options not available.

LOCKERS

# Locker Accessories

| CAT. NO.              | DESCRIPTION                 | WT. | PRICE   |
|-----------------------|-----------------------------|-----|---------|
| <b>NUMBER PLATES*</b> |                             |     |         |
| LNP-A                 | ALUMINUM NUMBER PLATES (25) | 2.5 | \$57.00 |
| <b>NAME PLATE</b>     |                             |     |         |
| LNP-2                 | TENNSCO NAME PLATE          | 0.1 | \$2.20  |

\*Available only in series of 25 (example: 1-25, 26-50, 51-75, etc.) ranging from 1 through 1000. Must specify number groups when ordering. A pop rivet gun is needed for installation.

## NUMBER PLATES & NAME PLATES



LNP-A



LNP-2

National Motor Freight Class: 85

Color options not available.

### FLAT TOP

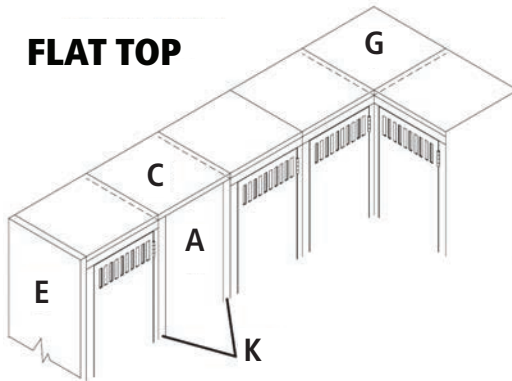

### SLOPING TOP

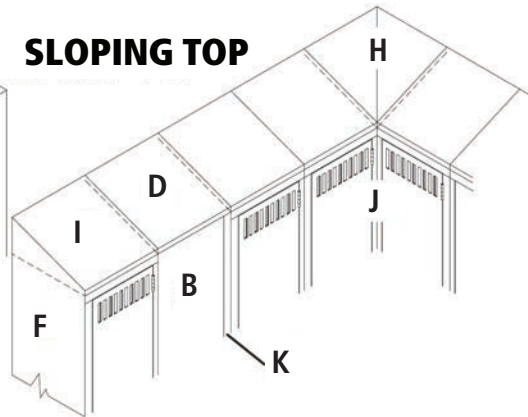

- A. FLAT FILLER PANEL
- B. ANGLE FILLER PANEL
- C. FLAT TOP FILLER
- D. SLOPING TOP FILLER
- E. FLAT TOP BOXED END PANEL
- F. SLOPING TOP BOXED END PANEL
- G. FLAT TOPPED CORNER FILLER
- H. SLOPING TOP CORNER FILLER
- I. SLOPING TOP
- J. CORNER ANGLE
- K. FILLER PANEL FRAMES

## FLAT AND ANGLE FILLER PANELS

| FLAT FILLER PANELS (A) |    |   |    |      |          |
|------------------------|----|---|----|------|----------|
| CAT. NO.               | W  | D | H  | WT.  | PRICE    |
| LFF-360                | 3  | — | 60 | 11.2 | \$107.00 |
| LFF-366                | 3  | — | 66 | 11.4 | 101.00   |
| LFF-372                | 3  | — | 72 | 11.6 | 103.00   |
| LFF-378                | 3  | — | 78 | 11.8 | 97.00    |
| LFF-960                | 9  | — | 60 | 14.8 | 124.00   |
| LFF-966                | 9  | — | 66 | 15.4 | 122.00   |
| LFF-972                | 9  | — | 72 | 15.9 | 124.00   |
| LFF-978                | 9  | — | 78 | 16.4 | 126.00   |
| LFF-1760               | 17 | — | 60 | 19.8 | 152.00   |
| LFF-1766               | 17 | — | 66 | 21.0 | 159.00   |
| LFF-1772               | 17 | — | 72 | 22.0 | 163.00   |
| LFF-1778               | 17 | — | 78 | 23.0 | 197.00   |



Flat Filler Panel

| ANGLE FILLER PANELS (B) |    |   |    |      |          |
|-------------------------|----|---|----|------|----------|
| CAT. NO.                | W  | D | H  | WT.  | PRICE    |
| LAF-360                 | 3  | — | 60 | 12.3 | \$188.00 |
| LAF-366                 | 3  | — | 66 | 12.5 | 167.00   |
| LAF-372                 | 3  | — | 72 | 12.8 | 169.00   |
| LAF-378                 | 3  | — | 78 | 13.1 | 190.00   |
| LAF-960                 | 9  | — | 60 | 16.0 | 205.00   |
| LAF-966                 | 9  | — | 66 | 16.7 | 201.00   |
| LAF-972                 | 9  | — | 72 | 17.3 | 193.00   |
| LAF-978                 | 9  | — | 78 | 18.0 | 214.00   |
| LAF-1760                | 17 | — | 60 | 21.0 | 226.00   |
| LAF-1766                | 17 | — | 66 | 22.0 | 218.00   |
| LAF-1772                | 17 | — | 72 | 23.0 | 186.00   |
| LAF-1778                | 17 | — | 78 | 25.0 | 241.00   |



Angle Filler Panel

TWO FILLER PANEL FRAMES MUST BE USED

ONE FILLER PANEL FRAME MUST BE USED

National Motor Freight Class: 85

## FLAT AND SLOPING TOP FILLERS

| FLAT TOP FILLERS (C) |    |    |   |     |         |
|----------------------|----|----|---|-----|---------|
| CAT. NO.             | W  | D  | H | WT. | PRICE   |
| LFTF-312             | 3  | 12 | — | 2.0 | \$73.00 |
| LFTF-315             | 3  | 15 | — | 2.1 | 75.00   |
| LFTF-318             | 3  | 18 | — | 2.2 | 82.00   |
| LFTF-321             | 3  | 21 | — | 2.4 | 82.00   |
| LFTF-324             | 3  | 24 | — | 2.6 | 86.00   |
| LFTF-912             | 9  | 12 | — | 2.7 | 86.00   |
| LFTF-915             | 9  | 15 | — | 2.9 | 79.00   |
| LFTF-918             | 9  | 18 | — | 3.2 | 80.00   |
| LFTF-921             | 9  | 21 | — | 3.5 | 90.00   |
| LFTF-924             | 9  | 24 | — | 3.8 | 79.00   |
| LFTF-1712            | 17 | 12 | — | 3.6 | 90.00   |
| LFTF-1715            | 17 | 15 | — | 4.0 | 95.00   |
| LFTF-1718            | 17 | 18 | — | 4.5 | 95.00   |
| LFTF-1721            | 17 | 21 | — | 5.0 | 98.00   |
| LFTF-1724            | 17 | 24 | — | 5.5 | 99.00   |



| SLOPING TOP FILLERS (D) |    |    |   |     |         |
|-------------------------|----|----|---|-----|---------|
| CAT. NO.                | W  | D  | H | WT. | PRICE   |
| LSTF-312                | 3  | 12 | — | 2.0 | \$83.00 |
| LSTF-315                | 3  | 15 | — | 2.1 | 83.00   |
| LSTF-318                | 3  | 18 | — | 2.2 | 71.00   |
| LSTF-321                | 3  | 21 | — | 2.4 | 86.00   |
| LSTF-324                | 3  | 24 | — | 2.5 | 86.00   |
| LSTF-912                | 9  | 12 | — | 2.7 | 80.00   |
| LSTF-915                | 9  | 15 | — | 2.9 | 88.00   |
| LSTF-918                | 9  | 18 | — | 3.2 | 73.00   |
| LSTF-921                | 9  | 21 | — | 3.5 | 91.00   |
| LSTF-1712               | 17 | 12 | — | 3.6 | 91.00   |
| LSTF-1715               | 17 | 15 | — | 4.1 | 95.00   |
| LSTF-1718               | 17 | 18 | — | 4.0 | 87.00   |
| LSTF-1721               | 17 | 21 | — | 5.0 | 99.00   |
| LSTF-1724               | 17 | 24 | — | 5.5 | 101.00  |

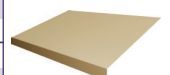

National Motor Freight Class: 85

### Standard Colors



## BOXED END PANELS



| FLAT TOP BOXED END PANELS (E) |   |    |    |     |                 |  |
|-------------------------------|---|----|----|-----|-----------------|--|
| CAT. NO.                      | W | D  | H  | WT. | PRICE           |  |
| LFTBE-1260                    | — | 12 | 60 | 28  | <b>\$193.00</b> |  |
| LFTBE-1560                    | — | 15 | 60 | 31  | <b>208.00</b>   |  |
| LFTBE-1860                    | — | 18 | 60 | 34  | <b>223.00</b>   |  |
| LFTBE-2160                    | — | 21 | 60 | 38  | <b>238.00</b>   |  |
| LFTBE-1266                    | — | 12 | 66 | 30  | <b>200.00</b>   |  |
| LFTBE-1566                    | — | 15 | 66 | 33  | <b>218.00</b>   |  |
| LFTBE-1866                    | — | 18 | 66 | 37  | <b>230.00</b>   |  |
| LFTBE-2166                    | — | 21 | 66 | 40  | <b>249.00</b>   |  |
| LFTBE-1272                    | — | 12 | 72 | 32  | <b>208.00</b>   |  |
| LFTBE-1572                    | — | 15 | 72 | 35  | <b>226.00</b>   |  |
| LFTBE-1872                    | — | 18 | 72 | 39  | <b>243.00</b>   |  |
| LFTBE-2172                    | — | 21 | 72 | 43  | <b>260.00</b>   |  |
| LFTBE-1278                    | — | 12 | 78 | 33  | <b>211.00</b>   |  |
| LFTBE-1578                    | — | 15 | 78 | 37  | <b>234.00</b>   |  |
| LFTBE-1878                    | — | 18 | 78 | 41  | <b>254.00</b>   |  |
| LFTBE-2178                    | — | 21 | 78 | 46  | <b>273.00</b>   |  |



| SLOPING TOP BOXED END PANELS (F) |   |    |    |     |                 |  |
|----------------------------------|---|----|----|-----|-----------------|--|
| CAT. NO.                         | W | D  | H  | WT. | PRICE           |  |
| LSTBE-1260                       | — | 12 | 60 | 29  | <b>\$271.00</b> |  |
| LSTBE-1560                       | — | 15 | 60 | 33  | <b>288.00</b>   |  |
| LSTBE-1860                       | — | 18 | 60 | 37  | <b>298.00</b>   |  |
| LSTBE-2160                       | — | 21 | 60 | 41  | <b>333.00</b>   |  |
| LSTBE-1266                       | — | 12 | 66 | 31  | <b>279.00</b>   |  |
| LSTBE-1566                       | — | 15 | 66 | 35  | <b>271.00</b>   |  |
| LSTBE-1866                       | — | 18 | 66 | 40  | <b>326.00</b>   |  |
| LSTBE-1272                       | — | 12 | 72 | 33  | <b>292.00</b>   |  |
| LSTBE-1572                       | — | 15 | 72 | 37  | <b>280.00</b>   |  |
| LSTBE-1872                       | — | 18 | 72 | 41  | <b>336.00</b>   |  |
| LSTBE-2172                       | — | 21 | 72 | 46  | <b>358.00</b>   |  |
| LSTBE-1278                       | — | 12 | 78 | 34  | <b>301.00</b>   |  |
| LSTBE-1578                       | — | 15 | 78 | 39  | <b>309.00</b>   |  |
| LSTBE-1878                       | — | 18 | 78 | 44  | <b>301.00</b>   |  |
| LSTBE-2178                       | — | 21 | 78 | 49  | <b>369.00</b>   |  |

NOTE: For left sloping panels, add -L to the catalog number; for right sloping panels, add -R to the catalog number.

National Motor Freight Class: 85

## CORNER FILLERS



| FLAT TOP CORNER FILLERS (G) |   |    |   |     |                |  |
|-----------------------------|---|----|---|-----|----------------|--|
| CAT. NO.                    | W | D  | H | WT. | PRICE          |  |
| LFCF-12                     | — | 12 | — | 3.5 | <b>\$88.00</b> |  |
| LFCF-15                     | — | 15 | — | 4.5 | <b>90.00</b>   |  |
| LFCF-18                     | — | 18 | — | 5.3 | <b>80.00</b>   |  |
| LFCF-21                     | — | 21 | — | 6.2 | <b>97.00</b>   |  |
| LFCF-24                     | — | 24 | — | 7.2 | <b>95.00</b>   |  |



| SLOPING TOP CORNER FILLERS (H) |   |    |   |     |                |  |
|--------------------------------|---|----|---|-----|----------------|--|
| CAT. NO.                       | W | D  | H | WT. | PRICE          |  |
| LSCF-12                        | — | 12 | — | 3.5 | <b>\$86.00</b> |  |
| LSCF-15                        | — | 15 | — | 4.4 | <b>98.00</b>   |  |
| LSCF-18                        | — | 18 | — | 5.5 | <b>98.00</b>   |  |
| LSCF-21                        | — | 21 | — | 6.7 | <b>117.00</b>  |  |
| LSCF-24                        | — | 24 | — | 7.7 | <b>124.00</b>  |  |

National Motor Freight Class: 85

## SLOPING TOPS\*



| SLOPING TOP — ONE WIDE (I) |    |    |   |     |                |  |
|----------------------------|----|----|---|-----|----------------|--|
| CAT. NO.                   | W  | D  | H | WT. | PRICE          |  |
| KST-1212▲                  | 12 | 12 | — | 3.6 | <b>\$61.00</b> |  |
| KST-1215▲                  | 12 | 15 | — | 4.3 | <b>73.00</b>   |  |
| KST-1218▲                  | 12 | 18 | — | 5.0 | <b>72.00</b>   |  |
| KST-1518▲                  | 15 | 18 | — | 5.5 | <b>82.00</b>   |  |
| KST-1521                   | 15 | 21 | — | 7.6 | <b>129.00</b>  |  |
| KST-1821                   | 18 | 21 | — | 7.9 | <b>113.00</b>  |  |
| KST-2424                   | 24 | 24 | — | 9.1 | <b>165.00</b>  |  |



| SLOPING TOP — THREE WIDE (I) |    |    |   |      |                |  |
|------------------------------|----|----|---|------|----------------|--|
| CAT. NO.                     | W  | D  | H | WT.  | PRICE          |  |
| KST-3612▲                    | 36 | 12 | — | 7.7  | <b>\$87.00</b> |  |
| KST-3615▲                    | 36 | 15 | — | 9.0  | <b>91.00</b>   |  |
| KST-3618▲                    | 36 | 18 | — | 10.1 | <b>99.00</b>   |  |
| KST-4518▲                    | 45 | 18 | — | 13.4 | <b>112.00</b>  |  |
| KST-4521                     | 45 | 21 | — | 15.0 | <b>185.00</b>  |  |

\*All sloping tops are shipped unassembled only.

National Motor Freight Class: 85

## CORNER ANGLES



Corner Angles are a vertical product, but shown horizontal for clarity of detail.

National Motor Freight Class: 85

| CORNER ANGLE (J) |   |   |    |     |                |  |
|------------------|---|---|----|-----|----------------|--|
| CAT. NO.         | W | D | H  | WT. | PRICE          |  |
| LCAF-60          | — | — | 60 | 3.9 | <b>\$58.00</b> |  |
| LCAF-66          | — | — | 66 | 4.2 | <b>61.00</b>   |  |
| LCAF-72          | — | — | 72 | 4.6 | <b>57.00</b>   |  |
| LCAF-78          | — | — | 78 | 4.8 | <b>63.00</b>   |  |

## FILLER PANEL FRAMES



Filler Panel Frames are a vertical product, but shown horizontal for clarity of detail.

National Motor Freight Class: 85

| FILLER PANEL FRAMES (K) |   |   |    |     |                |  |
|-------------------------|---|---|----|-----|----------------|--|
| CAT. NO.                | W | D | H  | WT. | PRICE          |  |
| LFPF-60                 | — | — | 60 | 3.4 | <b>\$79.00</b> |  |
| LFPF-66                 | — | — | 66 | 3.7 | <b>80.00</b>   |  |
| LFPF-72                 | — | — | 72 | 4.0 | <b>82.00</b>   |  |
| LFPF-78                 | — | — | 78 | 4.4 | <b>83.00</b>   |  |

### Standard Colors



▲ Items with these symbols are available to ship in 2-3 days. Limited quantities and select colors.



# Locker Accessories

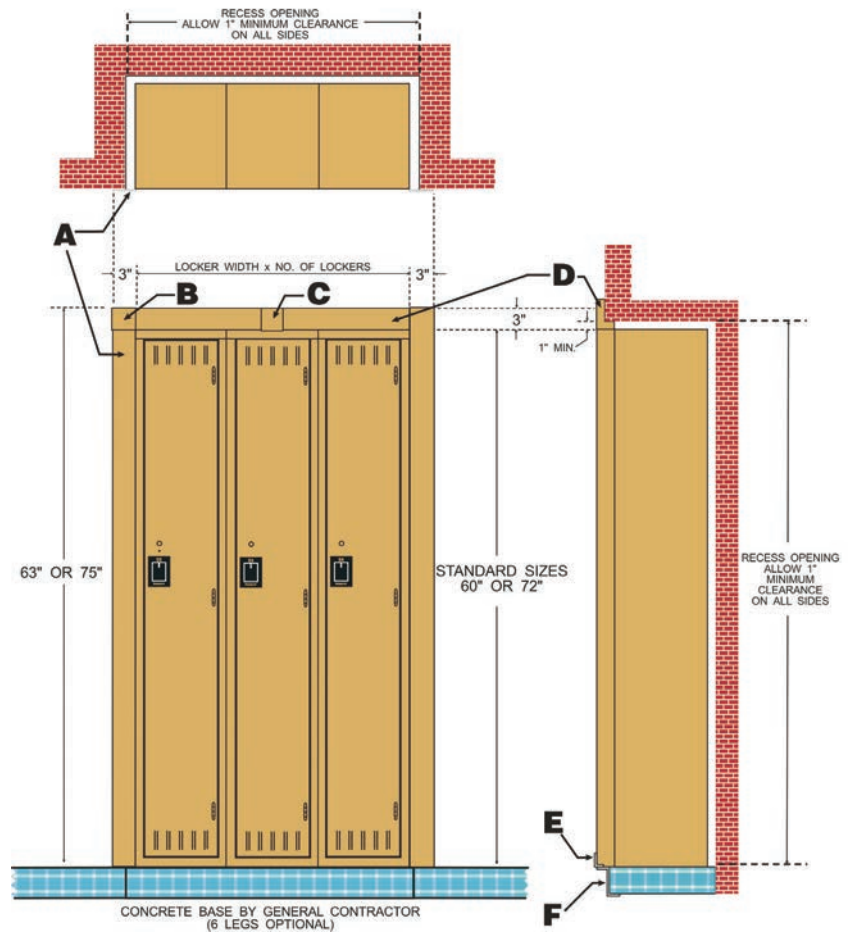

- A. VERTICAL TRIM
- B. CORNER SPLICE CAP
- C. SPLICE CAP
- D. HORIZONTAL TRIM
- E. BOTTOM ANGLE
- F. Z-BRACE

| CAT. NO. | DESCRIPTION     | W  | D | H  | WT. | PRICE   |
|----------|-----------------|----|---|----|-----|---------|
| LHT-72   | HORIZONTAL TRIM | 72 | — | 3  | 5.6 | \$79.00 |
| LVT-60L  | VERTICAL TRIM   | 3  | — | 60 | 6.2 | 82.00   |
| LVT-60R  | VERTICAL TRIM   | 3  | — | 60 | 6.2 | 82.00   |
| LVT-72L  | VERTICAL TRIM   | 3  | — | 72 | 7.4 | 82.00   |
| LVT-72R  | VERTICAL TRIM   | 3  | — | 72 | 7.4 | 82.00   |

National Motor Freight Class: 85

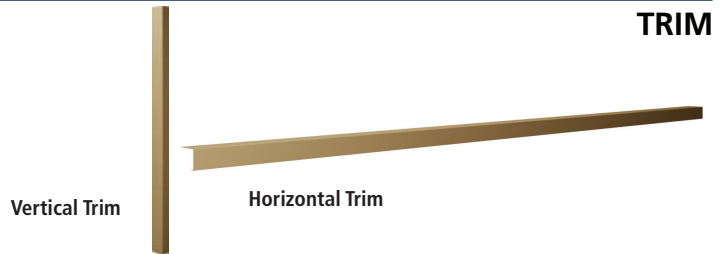

| CAT. NO. | DESCRIPTION        | W | D | H | WT. | PRICE   |
|----------|--------------------|---|---|---|-----|---------|
| LSC-1    | SPLICE CAP         | 3 | — | 3 | 0.2 | \$37.00 |
| LCSC-1   | CORNER SPLICE CAP  | 4 | — | 4 | 0.3 | 48.00   |
| LOCC-1   | OUTSIDE CORNER CAP | 3 | — | 6 | 0.3 | 35.00   |

National Motor Freight Class: 85



| CAT. NO. | DESCRIPTION  | W | D  | H | WT. | PRICE   |
|----------|--------------|---|----|---|-----|---------|
| LZB-12   | Z-BRACE      | — | 12 | 3 | 1.5 | \$34.00 |
| LZB-15   | Z-BRACE      | — | 15 | 3 | 1.9 | 49.00   |
| LZB-18   | Z-BRACE      | — | 18 | 3 | 2.2 | 50.00   |
| LBA-12   | BOTTOM ANGLE | 2 | 12 | — | 1.3 | 35.00   |
| LBA-15   | BOTTOM ANGLE | 2 | 15 | — | 1.6 | 48.00   |
| LBA-18   | BOTTOM ANGLE | 2 | 18 | — | 1.9 | 49.00   |

National Motor Freight Class: 85

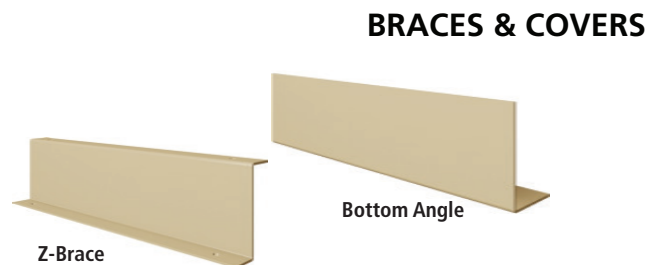

## Standard Colors



LOCKERS

# Locker Accessories

## ADA COMPLIANT LOCKERS



Tennsco ADA Compliant Lockers are specifically designed to provide easier access to contents from a seated position. This is achieved by adding a reduced-height upper shelf and coat hooks.

The special ADA compliant Key Cap increase the size of the key head making it easier to grip and turn allowing for single-handed operation.

The reduced height upper shelf and coat hooks bring items normally stored high in the locker down to a reachable level.

Tennsco will modify several of our standard lockers, offering a variety of choices. ADA Compliant Lockers are available for single tier, double tier (bottom locker only), and triple tier (bottom two lockers only) lockers, and can be custom ordered with the ADA features below. Call factory for details. You may also convert your existing lockers to be ADA compliant by ordering the options below.

All ADA Compliant Lockers are shipped with the universal handicap symbol.

Call factory for ADA Lock options.

## ADA REDUCED HEIGHT UPPER SHELVES



| CAT. NO.   | W  | D  | H | WT. | PRICE          |
|------------|----|----|---|-----|----------------|
| ADALS-1212 | 12 | 12 | — | 2.9 | <b>\$37.00</b> |
| ADALS-1215 | 12 | 15 | — | 3.3 | <b>\$34.00</b> |
| ADALS-1218 | 12 | 18 | — | 3.9 | <b>\$35.00</b> |
| ADALS-1518 | 15 | 18 | — | 4.6 | <b>\$45.00</b> |
| ADALS-1521 | 15 | 21 | — | 5.2 | <b>\$58.00</b> |

Shelf includes three coat hooks. May require drilling for installation.

National Motor Freight Class: 85

## ADA STICKER



| CAT. NO. | W | D | H | WT. | PRICE         |
|----------|---|---|---|-----|---------------|
| ADA-STK  | 2 | — | 2 | 0.1 | <b>\$7.60</b> |

Color options not available.

National Motor Freight Class: 85

### Standard Colors (Unless Otherwise Specified)



Sand (SND)    Champagne/ Putty (CPY)    Light Grey (LGY)    Medium Grey (MGY)    Black (BLK)



# Specialty Lockers

## CUBBIES

| CAT. NO.                                    | # OF OPENINGS | W       | D      | H     | WT.   | PRICE           |
|---|---------------|---------|--------|-------|-------|-----------------|
| CC-30                                       | 6             | 34 1/2  | 13 1/2 | 28    | 56.0  | <b>\$745.00</b> |
| CC-40                                       | 9             | 34 1/2  | 13 1/2 | 40    | 76.0  | <b>907.00</b>   |
| CC-52                                       | 12            | 34 1/2  | 13 1/2 | 52    | 97.0  | <b>1,121.00</b> |
| CC-66                                       | 15            | 34 1/2  | 13 1/2 | 66    | 120.0 | <b>1,310.00</b> |
| CC-78                                       | 18            | 34 1/2  | 13 1/2 | 78    | 140.0 | <b>1,436.00</b> |
| <b>CLEAR BINS FOR CUBBIES</b>               |               |         |        |       |       |                 |
| CCB-2                                       | -             | 10 3/32 | 13 3/4 | 2 1/4 | 3.8   | <b>\$60.00</b>  |
| CCB-4                                       | -             | 10 3/32 | 13 3/4 | 4 1/4 | 4.2   | <b>65.00</b>    |
| CCB-6                                       | -             | 10 3/32 | 13 3/4 | 6 1/4 | 4.5   | <b>73.00</b>    |
| CCB-8                                       | -             | 10 3/32 | 13 3/4 | 8 1/4 | 4.8   | <b>78.00</b>    |
| <b>EXTRA CUBBY SHELF WITH 4 SHELF CLIPS</b> |               |         |        |       |       |                 |
| ECS-1                                       | -             | 10      | 12 3/4 | 3/4   | 1.6   | <b>\$19.40</b>  |
| <b>EXTRA SHELF CLIP</b>                     |               |         |        |       |       |                 |
| CCC-1                                       | -             | -       | -      | -     | 0.1   | <b>\$1.10</b>   |
| <b>EXTRA COAT HOOK</b>                      |               |         |        |       |       |                 |
| LCH-2                                       | -             | -       | -      | -     | 0.2   | <b>\$5.20</b>   |

3 coat hooks included per unit. Shipped assembled.

National Motor Freight Class: 175



CC-78 with eight CCB-4



CC-66 with three CCB-6

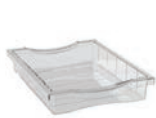

CCB-2



CCB-4



CCB-6



CCB-8



CC-30

LOCKERS

## CELL PHONE LOCKERS

| CATALOG NUMBER        | NO. OF COMPARTMENTS | OPENING                     |    |   | OVERALL UNIT |    |    | WEIGHT | PRICE             |  |
|-----------------------|---------------------|-----------------------------|----|---|--------------|----|----|--------|-------------------|--|
|                       |                     | W                           | D  | H | W            | D  | H  |        |                   |  |
| <b>10 DOORS HIGH</b>  |                     |                             |    |   |              |    |    |        |                   |  |
| CP10-091572-A         | 10                  | 9                           | 15 | 7 | 9            | 15 | 83 | 107    | <b>\$1,568.00</b> |  |
| CP10-091572-D         | 40                  | 9                           | 15 | 7 | 36           | 15 | 83 | 246    | <b>4,415.00</b>   |  |
| <b>12 DOORS HIGH</b>  |                     |                             |    |   |              |    |    |        |                   |  |
| CP12-091572-A         | 12                  | 9                           | 15 | 6 | 9            | 15 | 83 | 112    | <b>\$1,567.00</b> |  |
| CP12-091572-D         | 48                  | 9                           | 15 | 6 | 36           | 15 | 83 | 264    | <b>4,605.00</b>   |  |
| <b>NUMBER PLATES*</b> |                     |                             |    |   |              |    |    |        |                   |  |
| LNP-A                 |                     | ALUMINUM NUMBER PLATES (25) |    |   |              |    |    | 2.5    | <b>\$57.00</b>    |  |

\*Available only in series of 25 (example: 1-25, 26-50, 51-75, etc.) ranging from 1 through 1000. Must specify number groups when ordering. A pop rivet gun is needed for installation.

Shipped Assembled.

National Motor Freight Class: 175



CP10-091572-D



CP12-091572-A

### Standard Colors (Unless Otherwise Specified)



# Z-Line Low Profile & Long Span Units

## LOW PROFILE SHELVING



- Assembly required.  
National Motor Freight Class: 70

Starter units use four EUR uprights and six DRS end supports; adder units use two ZTP uprights and three DRS end supports. Particle board shelves are supported, on front and rear only, by low profile shelf supports (DRS-ww). 36" deep shelves are supported on all four sides.

| UNIT SIZE |    |    | SHELF LOAD CAPACITY* | STARTER UNITS  |       |          | ADDER UNITS    |       |          | EXTRA SHELF LEVEL |      |         |
|-----------|----|----|----------------------|----------------|-------|----------|----------------|-------|----------|-------------------|------|---------|
| W         | D  | H  |                      | CAT NO.        | WT.   | PRICE    | CAT NO.        | WT.   | PRICE    | CAT NO.           | WT.  | PRICE   |
| 36        | 12 | 84 | 600                  | ZA7-3612S-4D ▲ | 65.0  | \$263.00 | ZA7-3612A-4D ▲ | 63.0  | \$246.00 | ZAES-3612D ▲      | 10.9 | \$34.00 |
| 42        | 12 | 84 | 550                  | ZA7-4212S-4D ▲ | 73.0  | 289.00   | ZA7-4212A-4D ▲ | 71.0  | 272.00   | ZAES-4212D ▲      | 12.8 | 41.00   |
| 48        | 12 | 84 | 500                  | ZA7-4812S-4D ▲ | 80.0  | 304.00   | ZA7-4812A-4D ▲ | 78.0  | 287.00   | ZAES-4812D ▲      | 14.6 | 44.00   |
| 36        | 18 | 84 | 600                  | ZA7-3618S-4D ▲ | 83.0  | 302.00   | ZA7-3618A-4D ▲ | 80.0  | 280.00   | ZAES-3618D ▲      | 14.7 | 42.00   |
| 42        | 18 | 84 | 550                  | ZA7-4218S-4D ▲ | 93.0  | 332.00   | ZA7-4218A-4D ▲ | 89.0  | 310.00   | ZAES-4218D ▲      | 17.1 | 49.00   |
| 48        | 18 | 84 | 500                  | ZA7-4818S-4D ▲ | 103.0 | 349.00   | ZA7-4818A-4D ▲ | 99.0  | 327.00   | ZAES-4818D ▲      | 19.6 | 53.00   |
| 36        | 24 | 84 | 600                  | ZA7-3624S-4D ▲ | 99.0  | 334.00   | ZA7-3624A-4D ▲ | 95.0  | 312.00   | ZAES-3624D ▲      | 18.4 | 50.00   |
| 42        | 24 | 84 | 550                  | ZA7-4224S-4D ▲ | 111.0 | 372.00   | ZA7-4224A-4D ▲ | 107.0 | 350.00   | ZAES-4224D ▲      | 22.0 | 59.00   |
| 48        | 24 | 84 | 500                  | ZA7-4824S-4D ▲ | 124.0 | 389.00   | ZA7-4824A-4D ▲ | 120.0 | 367.00   | ZAES-4824D ▲      | 25.0 | 63.00   |
| 36        | 36 | 84 | 600                  | ZA7-3636S-4D ▲ | 136.0 | 425.00   | ZA7-3636A-4D ▲ | 135.0 | 423.00   | ZAES-3636D ▲      | 29.0 | 87.00   |
| 42        | 36 | 84 | 550                  | ZA7-4236S-4D ▲ | 154.0 | 462.00   | ZA7-4236A-4D ▲ | 153.0 | 460.00   | ZAES-4236D ▲      | 34.0 | 96.00   |
| 48        | 36 | 84 | 500                  | ZA7-4836S-4D ▲ | 175.0 | 500.00   | ZA7-4836A-4D ▲ | 174.0 | 498.00   | ZAES-4836D ▲      | 38.0 | 106.00  |

\*Load capacity in pounds per shelf level, evenly distributed. Total unit capacity, using four uprights, not to exceed 8,000 lbs., based on 24" centers or less.

## LONG SPAN SHELVING



- Assembly required.  
National Motor Freight Class: 70

Heavy duty long span units include 3 shelf levels. Units use SUR uprights. Shelves supported on all four sides with heavy duty profile shelf supports (LRA-xx).

| UNIT SIZE |    |    | SHELF LOAD CAPACITY* | REINFORCEMENTS PER LEVEL | UNITS WITH DECKING |       |          | EXTRA SHELF LEVEL |       |          |
|-----------|----|----|----------------------|--------------------------|--------------------|-------|----------|-------------------|-------|----------|
| W         | D  | H  |                      |                          | CAT NO.            | WT.   | PRICE    | CAT NO.           | WT.   | PRICE    |
| 48        | 24 | 84 | 2,250                | 1                        | ZL7-4824-3D ▲      | 125.0 | \$466.00 | ZLES-4824D ▲      | 33.0  | \$110.00 |
| 60        | 24 | 84 | 2,000                | 1                        | ZL7-6024-3D ▲      | 146.0 | 521.00   | ZLES-6024D ▲      | 40.0  | 128.00   |
| 72        | 24 | 84 | 1,750                | 2                        | ZL7-7224-3D ▲      | 173.0 | 635.00   | ZLES-7224D ▲      | 49.0  | 166.00   |
| 96        | 24 | 84 | 900                  | 3                        | ZL7-9624-3D ▲      | 220.0 | 782.00   | ZLES-9624D ▲      | 65.0  | 215.00   |
| 48        | 30 | 84 | 2,250                | 1                        | ZL7-4830-3D ▲      | 144.0 | 513.00   | ZLES-4830D ▲      | 39.0  | 126.00   |
| 60        | 30 | 84 | 2,000                | 1                        | ZL7-6030-3D ▲      | 169.0 | 577.00   | ZLES-6030D ▲      | 48.0  | 147.00   |
| 72        | 30 | 84 | 1,750                | 2                        | ZL7-7230-3D ▲      | 201.0 | 700.00   | ZLES-7230D ▲      | 58.0  | 188.00   |
| 96        | 30 | 84 | 900                  | 3                        | ZL7-9630-3D ▲      | 256.0 | 859.00   | ZLES-9630D ▲      | 77.0  | 241.00   |
| 48        | 36 | 84 | 2,250                | 1                        | ZL7-4836-3D ▲      | 166.0 | 559.00   | ZLES-4836D ▲      | 47.0  | 141.00   |
| 60        | 36 | 84 | 2,000                | 1                        | ZL7-6036-3D ▲      | 192.0 | 644.00   | ZLES-6036D ▲      | 55.0  | 169.00   |
| 72        | 36 | 84 | 1,750                | 2                        | ZL7-7236-3D ▲      | 229.0 | 757.00   | ZLES-7236D ▲      | 68.0  | 207.00   |
| 96        | 36 | 84 | 900                  | 3                        | ZL7-9636-3D ▲      | 293.0 | 954.00   | ZLES-9636D ▲      | 89.0  | 273.00   |
| 48        | 48 | 84 | 2,250                | 1                        | ZL7-4848-3D ▲      | 202.0 | 624.00   | ZLES-4848D ▲      | 59.0  | 150.00   |
| 60        | 48 | 84 | 2,000                | 1                        | ZL7-6048-3D ▲      | 238.0 | 727.00   | ZLES-6048D ▲      | 71.0  | 197.00   |
| 72        | 48 | 84 | 1,750                | 2                        | ZL7-7248-3D ▲      | 285.0 | 890.00   | ZLES-7248D ▲      | 86.0  | 251.00   |
| 96        | 48 | 84 | 900                  | 3                        | ZL7-9648-3D ▲      | 367.0 | 1,128.00 | ZLES-9648D ▲      | 114.0 | 331.00   |

\*Load capacity in pounds per shelf level, evenly distributed. Total unit capacity not to exceed 13,000 lbs. per unit (3,250 lbs. per post) based on 24" centers or less.

### Standard Colors



▲ Items with these symbols are available to ship in 2-3 days. Limited quantities and select colors.



# Steel Shelf Units



## SOLID STEEL SHELF UNITS

- Assembly required.  
National Motor Freight Class: 70

Starter and adder units include 5 shelf levels. Starter units use 4 EUR uprights; adder units use 2 ZTP uprights. Each unit is stabilized by VDRS shelf supports at both top and bottom. Intermediate shelves are attached by 4 ZSC-1 shelf clips. No sway braces required, allowing access from all 4 sides.

| UNIT SIZE |    |    | SHELF LOAD CAPACITY* | STARTER UNITS  |       |          | ADDER UNITS    |       |          | EXTRA SHELF LEVEL |      |         |
|-----------|----|----|----------------------|----------------|-------|----------|----------------|-------|----------|-------------------|------|---------|
| W         | D  | H  |                      | CAT NO.        | WT.   | PRICE    | CAT NO.        | WT.   | PRICE    | CAT NO.           | WT.  | PRICE   |
| 36        | 12 | 84 | 750                  | ZM7-3612S-5D ♣ | 61.0  | \$371.00 | ZM7-3612A-5D ♣ | 59.0  | \$359.00 | ZMS-3612 ♣        | 6.7  | \$44.00 |
| 42        | 12 | 84 | 600                  | ZM7-4212S-5D ♣ | 68.0  | 428.00   | ZM7-4212A-5D ♣ | 66.0  | 416.00   | ZMS-4212 ♣        | 7.7  | 54.00   |
| 48        | 12 | 84 | 500                  | ZM7-4812S-5D ♣ | 74.0  | 422.00   | ZM7-4812A-5D ♣ | 72.0  | 410.00   | ZMS-4812 ♣        | 8.7  | 52.00   |
| 36        | 18 | 84 | 750                  | ZM7-3618S-5D ♣ | 73.0  | 426.00   | ZM7-3618A-5D ♣ | 70.0  | 411.00   | ZMS-3618 ♣        | 8.8  | 54.00   |
| 42        | 18 | 84 | 600                  | ZM7-4218S-5D ♣ | 81.0  | 474.00   | ZM7-4218A-5D ♣ | 78.0  | 459.00   | ZMS-4218 ♣        | 10.1 | 62.00   |
| 48        | 18 | 84 | 500                  | ZM7-4818S-5D ♣ | 89.0  | 503.00   | ZM7-4818A-5D ♣ | 86.0  | 488.00   | ZMS-4818 ♣        | 11.4 | 67.00   |
| 36        | 24 | 84 | 700                  | ZM7-3624S-5D ♣ | 85.0  | 482.00   | ZM7-3624A-5D ♣ | 81.0  | 464.00   | ZMS-3624 ♣        | 10.9 | 64.00   |
| 42        | 24 | 84 | 550                  | ZM7-4224S-5D ♣ | 95.0  | 539.00   | ZM7-4224A-5D ♣ | 91.0  | 522.00   | ZMS-4224 ♣        | 12.5 | 74.00   |
| 48        | 24 | 84 | 450                  | ZM7-4824S-5D ♣ | 104.0 | 563.00   | ZM7-4824A-5D ♣ | 100.0 | 545.00   | ZMS-4824 ♣        | 14.1 | 78.00   |
| 36        | 36 | 84 | 600                  | ZM7-3636S-5D ♣ | 122.0 | 772.00   | ZM7-3636A-5D ♣ | 118.0 | 747.00   | ZMS-3636 ♣        | 17.9 | 119.00  |
| 42        | 36 | 84 | 550                  | ZM7-4236S-5D ♣ | 137.0 | 843.00   | ZM7-4236A-5D ♣ | 132.0 | 809.00   | ZMS-4236 ♣        | 21.0 | 130.00  |
| 48        | 36 | 84 | 450                  | ZM7-4836S-5D ♣ | 150.0 | 903.00   | ZM7-4836A-5D ♣ | 146.0 | 878.00   | ZMS-4836 ♣        | 23.0 | 143.00  |

\*Load capacity figures are calculated in pounds per shelf level, evenly distributed. Total unit capacity, using four EUR uprights, not to exceed 8,000 lbs., based on 24" centers or less.



## PERFORATED STEEL SHELF UNITS

- Assembly required.  
National Motor Freight Class: 70

SHELVING

Starter and adder units include 5 shelf levels. Starter units use 4 EUR uprights; adder units use 2 ZTP uprights. Each unit is stabilized by VDRS shelf supports at both top and bottom. Intermediate shelves are attached by 4 ZSC-1 shelf clips. No sway braces required, allowing access from all 4 sides.

| UNIT SIZE |    |    | SHELF LOAD CAPACITY* | STARTER UNITS |                 |       | ADDER UNITS |                 |       | EXTRA SHELF LEVEL |             |       |         |
|-----------|----|----|----------------------|---------------|-----------------|-------|-------------|-----------------|-------|-------------------|-------------|-------|---------|
| W         | D  | H  |                      | CAT NO.       | WT.             | PRICE | CAT NO.     | WT.             | PRICE | CAT NO.           | WT.         | PRICE |         |
| NEW       | 36 | 12 | 84                   | 450           | ZM7-3612S-5PD ♣ | 61.0  | \$395.00    | ZM7-3612A-5PD ♣ | 59.0  | \$395.00          | ZMPS-3612 ♣ | 6.7   | \$48.00 |
|           | 48 | 12 | 84                   | 300           | ZM7-4812S-5PD ♣ | 74.0  | 452.00      | ZM7-4812A-5PD ♣ | 72.0  | 453.00            | ZMPS-4812 ♣ | 8.7   | 58.00   |
| NEW       | 36 | 18 | 84                   | 450           | ZM7-3618S-5PD ♣ | 73.0  | 491.00      | ZM7-3618A-5PD ♣ | 70.0  | 496.00            | ZMPS-3618 ♣ | 8.8   | 67.00   |
|           | 42 | 18 | 84                   | 375           | ZM7-4218S-5PD ♣ | 81.0  | 494.00      | ZM7-4218A-5PD ♣ | 78.0  | 479.00            | ZMPS-4218 ♣ | 10.1  | 66.00   |
|           | 48 | 18 | 84                   | 300           | ZM7-4818S-5PD ♣ | 89.0  | 533.00      | ZM7-4818A-5PD ♣ | 86.0  | 534.00            | ZMPS-4818 ♣ | 11.4  | 73.00   |
| NEW       | 36 | 24 | 84                   | 450           | ZM7-3624S-5PD ♣ | 85.0  | 532.00      | ZM7-3624A-5PD ♣ | 81.0  | 514.00            | ZMPS-3624 ♣ | 10.9  | 74.00   |
|           | 42 | 24 | 84                   | 325           | ZM7-4224S-5PD ♣ | 95.0  | 549.00      | ZM7-4224A-5PD ♣ | 91.0  | 549.00            | ZMPS-4224 ♣ | 12.5  | 75.00   |
|           | 48 | 24 | 84                   | 250           | ZM7-4824S-5PD ♣ | 104.0 | 613.00      | ZM7-4824A-5PD ♣ | 100.0 | 615.00            | ZMPS-4824 ♣ | 14.1  | 88.00   |
| NEW       | 36 | 36 | 84                   | 400           | ZM7-3636S-5PD ♣ | 122.0 | 704.00      | ZM7-3636A-5PD ♣ | 118.0 | 722.00            | ZMPS-3636 ♣ | 17.9  | 108.00  |
|           | 42 | 36 | 84                   | 250           | ZM7-4236S-5PD ♣ | 137.0 | 780.00      | ZM7-4236A-5PD ♣ | 132.0 | 799.00            | ZMPS-4236 ♣ | 21.0  | 122.00  |
|           | 48 | 36 | 84                   | 175           | ZM7-4836S-5PD ♣ | 150.0 | 818.00      | ZM7-4836A-5PD ♣ | 146.0 | 822.00            | ZMPS-4836 ♣ | 23.0  | 126.00  |

\*Load capacity figures are calculated in pounds per shelf level, evenly distributed. Total unit capacity, using four EUR uprights, not to exceed 8,000 lbs., based on 24" centers or less.

### Standard Colors



♣ Items with these symbols are available to ship in 2-3 days. Limited quantities and select colors.



## RECORD ARCHIVE STORAGE RACKS

| UNIT SIZE |    |    | NO. OF OPENINGS | SHELF LOAD CAPACITY* | SHELVING UNITS |       |                 |
|-----------|----|----|-----------------|----------------------|----------------|-------|-----------------|
| W         | D  | H  |                 |                      | CAT NO.        | WT.   | PRICE           |
| 42        | 15 | 60 | 2               | 2,250                | ZA421560-3D ▲  | 73.0  | <b>\$286.00</b> |
| 69        | 15 | 60 | 2               | 1,800                | ZA691560-3D ▲  | 111.0 | <b>416.00</b>   |
| 42        | 15 | 84 | 3               | 2,250                | ZA421584-4D ▲  | 98.0  | <b>384.00</b>   |
| 69        | 15 | 84 | 3               | 1,800                | ZA691584-4D ▲  | 148.0 | <b>558.00</b>   |
| 42        | 30 | 60 | 2               | 2,250                | ZA423060-3D ▲  | 113.0 | <b>367.00</b>   |
| 69        | 30 | 60 | 2               | 1,800                | ZA693060-3D ▲  | 175.0 | <b>582.00</b>   |
| 42        | 30 | 84 | 3               | 2,250                | ZA423084-4D ▲  | 151.0 | <b>492.00</b>   |
| 69        | 30 | 84 | 3               | 1,800                | ZA693084-4D ▲  | 234.0 | <b>780.00</b>   |

\*Load capacity figures are calculated in pounds per shelf level, evenly distributed. Total unit capacity, using four EUR uprights, not to exceed 8,000 lbs., based on 24" centers or less.



ZA423084-4D

National Motor Freight Class: 70

- Assembly required.

## HEAVY-DUTY REINFORCED SHELVING (DIE RACK UNIT)



RXHS-602484

Die rack units include 5 shelf levels.

Available in Medium Grey only.

- Assembly required.

National Motor Freight Class: 70



RXHS-962484

| UNIT SIZE |    |    | SHELF LOAD CAPACITY* | REINFORCEMENTS PER LEVEL | SHELVING UNITS |       |                 | EXTRA SHELF LEVEL |       |                 |
|-----------|----|----|----------------------|--------------------------|----------------|-------|-----------------|-------------------|-------|-----------------|
| W         | D  | H  |                      |                          | CAT NO.        | WT.   | PRICE           | CAT NO.           | WT.   | PRICE           |
| 36        | 18 | 72 | 4,000                | 1                        | RXHS-361872 ♣  | 147.0 | <b>\$860.00</b> | RXHS-3618 ♣       | 25.0  | <b>\$162.00</b> |
| 48        | 18 | 72 | 4,000                | 1                        | RXHS-481872 ♣  | 181.0 | <b>1,053.00</b> | RXHS-4818 ♣       | 32.0  | <b>187.00</b>   |
| 36        | 18 | 84 | 4,000                | 1                        | RXHS-361884 ♣  | 151.0 | <b>884.00</b>   | RXHS-3618 ♣       | 25.0  | <b>162.00</b>   |
| 48        | 18 | 84 | 4,000                | 1                        | RXHS-481884 ♣  | 185.0 | <b>1,077.00</b> | RXHS-4818 ♣       | 32.0  | <b>187.00</b>   |
| 36        | 18 | 96 | 4,000                | 1                        | RXHS-361896 ♣  | 155.0 | <b>904.00</b>   | RXHS-3618 ♣       | 25.0  | <b>162.00</b>   |
| 48        | 18 | 96 | 4,000                | 1                        | RXHS-481896 ♣  | 189.0 | <b>1,097.00</b> | RXHS-4818 ♣       | 32.0  | <b>187.00</b>   |
| 36        | 24 | 72 | 4,000                | 1                        | RXHS-362472 ♣  | 202.0 | <b>988.00</b>   | RXHS-3624 ♣       | 32.0  | <b>174.00</b>   |
| 48        | 24 | 72 | 4,000                | 1                        | RXHS-482472 ♣  | 214.0 | <b>1,153.00</b> | RXHS-4824 ♣       | 40.0  | <b>212.00</b>   |
| 60        | 24 | 72 | 3,250                | 1                        | RXHS-602472 ♣  | 255.0 | <b>1,374.00</b> | RXHS-6024 ♣       | 47.0  | <b>273.00</b>   |
| 72        | 24 | 72 | 2,750                | 2                        | RXHS-722472 ♣  | 305.0 | <b>1,627.00</b> | RXHS-7224 ♣       | 57.0  | <b>330.00</b>   |
| 36        | 24 | 84 | 4,000                | 1                        | RXHS-362484 ♣  | 206.0 | <b>1,012.00</b> | RXHS-3624 ♣       | 32.0  | <b>174.00</b>   |
| 48        | 24 | 84 | 4,000                | 1                        | RXHS-482484 ♣  | 218.0 | <b>1,177.00</b> | RXHS-4824 ♣       | 40.0  | <b>212.00</b>   |
| 60        | 24 | 84 | 3,250                | 1                        | RXHS-602484 ♣  | 259.0 | <b>1,398.00</b> | RXHS-6024 ♣       | 47.0  | <b>273.00</b>   |
| 72        | 24 | 84 | 2,750                | 2                        | RXHS-722484 ♣  | 309.0 | <b>1,651.00</b> | RXHS-7224 ♣       | 57.0  | <b>330.00</b>   |
| 96        | 24 | 84 | 2,600                | 3                        | RXHS-962484 ♣  | 413.0 | <b>2,263.00</b> | RXHS-9624 ♣       | 78.0  | <b>432.00</b>   |
| 36        | 24 | 96 | 4,000                | 1                        | RXHS-362496 ♣  | 210.0 | <b>1,032.00</b> | RXHS-3624 ♣       | 32.0  | <b>174.00</b>   |
| 48        | 24 | 96 | 4,000                | 1                        | RXHS-482496 ♣  | 222.0 | <b>1,197.00</b> | RXHS-4824 ♣       | 40.0  | <b>212.00</b>   |
| 60        | 24 | 96 | 3,250                | 1                        | RXHS-602496 ♣  | 263.0 | <b>1,418.00</b> | RXHS-6024 ♣       | 47.0  | <b>273.00</b>   |
| 72        | 24 | 96 | 2,750                | 2                        | RXHS-722496 ♣  | 313.0 | <b>1,671.00</b> | RXHS-7224 ♣       | 57.0  | <b>330.00</b>   |
| 96        | 24 | 96 | 2,600                | 3                        | RXHS-962496 ♣  | 417.0 | <b>2,283.00</b> | RXHS-9624 ♣       | 78.0  | <b>432.00</b>   |
| 72        | 36 | 84 | 2,750                | 2                        | RXHS-723684 ♣  | 419.0 | <b>2,222.00</b> | RXHS-7236 ♣       | 79.0  | <b>423.00</b>   |
| 96        | 36 | 84 | 2,600                | 3                        | RXHS-963684 ♣  | 560.0 | <b>2,804.00</b> | RXHS-9636 ♣       | 108.0 | <b>541.00</b>   |
| 72        | 36 | 96 | 2,750                | 2                        | RXHS-723696 ♣  | 424.0 | <b>2,242.00</b> | RXHS-7236 ♣       | 79.0  | <b>423.00</b>   |
| 96        | 36 | 96 | 2,600                | 3                        | RXHS-963696 ♣  | 565.0 | <b>2,824.00</b> | RXHS-9636 ♣       | 108.0 | <b>541.00</b>   |

\*Load capacities are per shelf, evenly distributed. Weight not to exceed a total of 13,000 lbs. per unit and based on shelves spaced on 24" centers. Other heights are available; call factory for pricing.

### Standard Colors



▲ ♣  
Items with these symbols are available to ship in 2-3 days. Limited quantities and select colors.

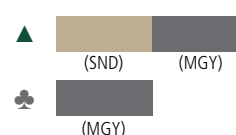

# Z-Line Sloping Shelf & Tire Rack Units

## SLOPING SHELF UNITS (FLAT SLOPE STYLE)



Includes 5 sloped shelves and one top shelf.



Units can be placed back to back for double entry (shown).

- Assembly required.  
National Motor Freight Class: 70

| UNIT SIZE |    |    | SHELF LOAD CAPACITY* | STARTER UNITS |       |                 | ADDER UNITS  |       |                 | EXTRA SHELF LEVEL |      |                 |
|-----------|----|----|----------------------|---------------|-------|-----------------|--------------|-------|-----------------|-------------------|------|-----------------|
| W         | D  | H  |                      | CAT NO.       | WT.   | PRICE           | CAT NO.      | WT.   | PRICE           | CAT NO.           | WT.  | PRICE           |
| 36        | 18 | 84 | 450                  | ZT7-3618S-5♣  | 137.0 | <b>\$931.00</b> | ZT7-3618A-5♣ | 136.0 | <b>\$929.00</b> | ZSSS-3618         | 17.9 | <b>\$142.00</b> |
| 48        | 18 | 84 | 350                  | ZT7-4818S-5♣  | 187.0 | <b>1,185.00</b> | ZT7-4818A-5♣ | 186.0 | <b>1,183.00</b> | ZSSS-4818         | 27.0 | <b>182.00</b>   |
| 36        | 24 | 84 | 450                  | ZT7-3624S-5♣  | 160.0 | <b>1,046.00</b> | ZT7-3624A-5♣ | 159.0 | <b>1,044.00</b> | ZSSS-3624         | 23.0 | <b>165.00</b>   |
| 48        | 24 | 84 | 350                  | ZT7-4824S-5♣  | 217.0 | <b>1,305.00</b> | ZT7-4824A-5♣ | 217.0 | <b>1,303.00</b> | ZSSS-4824         | 33.0 | <b>201.00</b>   |

\*Load capacities are per shelf, evenly distributed and based on shelves spaced on 24" centers. Weight not to exceed a total of 1,500 lbs. per unit.

## TIRE RACK



ZST-6084S



ZDT-6084S

NOT FOR USE WITH TIRES MOUNTED ON WHEELS

NOTE: Single Entry units must be tied to wall.

Single Entry units include one 12" deep unit and one 9" wall tie.

Double Entry units include two 12" deep units and one 18" deep cross aisle tie.

- Assembly required.

National Motor Freight Class: 70

| UNIT SIZE           |      |     | # OF OPENINGS | TIRE CAP. | STARTER UNITS |       |                 | ADDER UNITS |       |                 |
|---------------------|------|-----|---------------|-----------|---------------|-------|-----------------|-------------|-------|-----------------|
| W                   | D    | H   |               |           | CAT NO.       | WT.   | PRICE           | CAT NO.     | WT.   | PRICE           |
| <b>SINGLE ENTRY</b> |      |     |               |           |               |       |                 |             |       |                 |
| 60                  | 21*  | 60  | 2             | 16        | ZST-6060S▲    | 38.0  | <b>\$219.00</b> | ZST-6060A▲  | 34.0  | <b>\$199.00</b> |
| 60                  | 21*  | 84  | 3             | 24        | ZST-6084S▲    | 53.0  | <b>293.00</b>   | ZST-6084A▲  | 48.0  | <b>265.00</b>   |
| 60                  | 21*  | 120 | 4             | 32        | ZST-60120S▲   | 74.0  | <b>422.00</b>   | ZST-60120A▲ | 67.0  | <b>371.00</b>   |
| 60                  | 21*  | 144 | 5             | 40        | ZST-60144S▲   | 91.0  | <b>515.00</b>   | ZST-60144A▲ | 82.0  | <b>463.00</b>   |
| <b>DOUBLE ENTRY</b> |      |     |               |           |               |       |                 |             |       |                 |
| 60                  | 42** | 60  | 4             | 32        | ZDT-6060S▲    | 80.0  | <b>\$475.00</b> | ZDT-6060A▲  | 70.0  | <b>\$416.00</b> |
| 60                  | 42** | 84  | 6             | 48        | ZDT-6084S▲    | 108.0 | <b>624.00</b>   | ZDT-6084A▲  | 98.0  | <b>548.00</b>   |
| 60                  | 42** | 120 | 8             | 64        | ZDT-60120S▲   | 146.0 | <b>826.00</b>   | ZDT-60120A▲ | 133.0 | <b>733.00</b>   |
| 60                  | 42** | 144 | 10            | 80        | ZDT-60144S▲   | 178.0 | <b>1,012.00</b> | ZDT-60144A▲ | 172.0 | <b>984.00</b>   |

\*Single Entry units include one 12" deep unit and necessary 9" deep wall tie(s). Quantity depends on height.

\*\*Double Entry units include two 12" deep units and necessary 18" deep cross aisle tie(s). Quantity depends on height.

### Standard Colors



Sand (SND) Light Grey (LGY) Medium Grey (MGY)

▲ ♣  
Items with these symbols are available to ship in 2-3 days. Limited quantities and select colors.

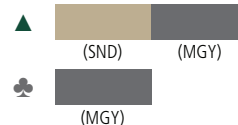

(SND) (MGY)  
(MGY)

## HORIZONTAL BAR RACK

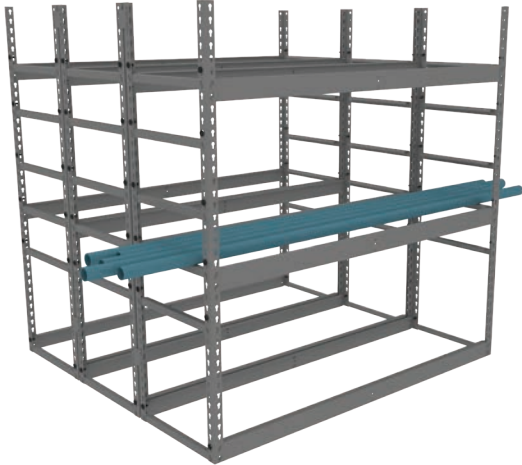

| UNIT SIZE<br>W D H  | NO. OF<br>BAYS | BAY<br>CAPACITY | SHELVING UNITS |                        |
|---------------------|----------------|-----------------|----------------|------------------------|
|                     |                |                 | CAT NO.        | WT. PRICE              |
| <b>NEW</b> 56 60 60 | 15             | 500*            | PR-601860-6    | 160.0 <b>\$1484.00</b> |

\*Load capacity per bay is based on evenly distributed loads. Overall unit capacity not to exceed 8,000 lbs.

Storage bays snap into place and adjust at 1 1/2" increments.

Available in Medium Grey only.

National Motor Freight Class: 70

- Assembly required.

## REEL RACK



| UNIT SIZE<br>W D H  | ROD<br>CAPACITY | UNIT<br>CAPACITY | CAT NO.           | SHELVING UNITS |                 |
|---------------------|-----------------|------------------|-------------------|----------------|-----------------|
|                     |                 |                  |                   | WT.            | PRICE           |
| <b>NEW</b> 36 24 84 | 150*            | 2,000            | REEL-362484-6-MGY | 84.0           | <b>\$814.00</b> |
| 48 24 84            | 100*            | 2,000            | REEL-482484-6-MGY | 93.0           | <b>\$14.00</b>  |
| <b>EXTRA RODS</b>   |                 |                  |                   |                |                 |
| 36 5/8 --           | 150*            | --               | 045CR-MGY         | 0.9            | <b>\$34.50</b>  |
| 48 5/8 --           | 100*            | --               | 055CR-MGY         | 1.3            | <b>\$4.50</b>   |

Levels adjust vertically in 1 1/2" increments to customize storage. Each level can hold up to 3 rods. Reel rack unit includes 6 rods.

\*Rod capacity is based on evenly distributed loads.

Available in Medium Grey only.

National Motor Freight Class: 70

- Assembly required.

## STUR-D-STOR SHELVING



May be configured as a five-shelf shelving unit or as a work table.



| CAT. NO.                              | SHELF LEV. CAP. | NO. OF OPENINGS | W      | D      | H   | WT.   | PRICE           |
|---------------------------------------|-----------------|-----------------|--------|--------|-----|-------|-----------------|
| <b>SHELVING PACKAGE</b>               |                 |                 |        |        |     |       |                 |
| LSS-361872                            | 1,000           | 4               | 36 1/2 | 18 1/2 | 72  | 88.0  | <b>\$397.00</b> |
| LSS-482484                            | 850             | 4               | 48 1/2 | 24 1/2 | 84  | 142.0 | <b>\$13.00</b>  |
| <b>HARD NYLON PROTECTIVE FOOT CAP</b> |                 |                 |        |        |     |       |                 |
| EURNF                                 | —               | —               | 1 1/2  | 1 1/2  | 3/4 | 0.1   | <b>\$1.40</b>   |

Includes 1/2" thick particleboard shelves and 8 plastic post caps. Ships in one pre-packaged box.

Shelving available in Sand only. Protective foot caps are available in Black only.

- Assembly required.

National Motor Freight Class: 70



EURNF

### Standard Colors (Unless Otherwise Specified)



Items with these symbols are available to ship in 2-3 days. Limited quantities and select colors.

■ ● ■ ●  
 (SND) (BLK)

# Z-Line Components: Posts & Supports

## UPRIGHT POSTS

| CAT. NO.                        | W       | D       | LENGTH | WT.  | PRICE   |
|---------------------------------|---------|---------|--------|------|---------|
| <b>STANDARD ANGLE POST</b>      |         |         |        |      |         |
| EUR-36 ▲                        | 1 15/32 | 1 15/32 | 36     | 2.0  | \$11.70 |
| EUR-48 ▲                        | 1 15/32 | 1 15/32 | 48     | 2.7  | 15.10   |
| EUR-60 ▲                        | 1 15/32 | 1 15/32 | 60     | 3.4  | 17.40   |
| EUR-72 ▲                        | 1 15/32 | 1 15/32 | 72     | 4.0  | 20.00   |
| EUR-84 ▲                        | 1 15/32 | 1 15/32 | 84     | 4.7  | 24.00   |
| EUR-96 ▲                        | 1 15/32 | 1 15/32 | 96     | 5.4  | 27.00   |
| EUR-108 ▲                       | 1 15/32 | 1 15/32 | 108    | 6.0  | 31.00   |
| EUR-120 ▲                       | 1 15/32 | 1 15/32 | 120    | 6.7  | 34.00   |
| EUR-132                         | 1 15/32 | 1 15/32 | 132    | 7.4  | 39.00   |
| EUR-144 ▲                       | 1 15/32 | 1 15/32 | 144    | 8.1  | 42.00   |
| <b>INTERMEDIATE "T" POST</b>    |         |         |        |      |         |
| ZTP-36                          | 3 3/8   | 1 15/32 | 36     | 3.9  | \$22.00 |
| ZTP-48 ▲                        | 3 3/8   | 1 15/32 | 48     | 5.1  | 30.00   |
| ZTP-60 ▲                        | 3 3/8   | 1 15/32 | 60     | 6.4  | 38.00   |
| ZTP-72 ▲                        | 3 3/8   | 1 15/32 | 72     | 7.7  | 43.00   |
| ZTP-84 ▲                        | 3 3/8   | 1 15/32 | 84     | 9.0  | 47.00   |
| ZTP-96 ▲                        | 3 3/8   | 1 15/32 | 96     | 10.3 | 57.00   |
| ZTP-108 ▲                       | 3 3/8   | 1 15/32 | 108    | 11.6 | 59.00   |
| ZTP-120 ▲                       | 3 3/8   | 1 15/32 | 120    | 12.8 | 66.00   |
| ZTP-132                         | 3 3/8   | 1 15/32 | 132    | 14.1 | 78.00   |
| ZTP-144 ▲                       | 3 3/8   | 1 15/32 | 144    | 15.4 | 85.00   |
| <b>HIGH CAPACITY ANGLE POST</b> |         |         |        |      |         |
| SUR-36                          | 2 1/16  | 2 1/16  | 36     | 2.8  | \$15.90 |
| SUR-48                          | 2 1/16  | 2 1/16  | 48     | 3.7  | 21.00   |
| SUR-60 ▲                        | 2 1/16  | 2 1/16  | 60     | 4.7  | 25.00   |
| SUR-72 ▲                        | 2 1/16  | 2 1/16  | 72     | 5.4  | 28.00   |
| SUR-84 ▲                        | 2 1/16  | 2 1/16  | 84     | 6.5  | 34.00   |
| SUR-96 ▲                        | 2 1/16  | 2 1/16  | 96     | 7.6  | 39.00   |
| SUR-108                         | 2 1/16  | 2 1/16  | 108    | 8.5  | 45.00   |
| SUR-120 ▲                       | 2 1/16  | 2 1/16  | 120    | 9.2  | 47.00   |
| SUR-132                         | 2 1/16  | 2 1/16  | 132    | 10.4 | 54.00   |
| SUR-144 ▲                       | 2 1/16  | 2 1/16  | 144    | 11.4 | 58.00   |
| SUR-168                         | 2 1/16  | 2 1/16  | 168    | 13.3 | 68.00   |
| SUR-181.5                       | 2 1/16  | 2 1/16  | 181.5  | 14.3 | 74.00   |



### STANDARD ANGLE POST (EUR)

Total weight capacity not to exceed 8,000 lbs. per unit (2,000 lbs. per post), based on 24" shelf centers or less.

### INTERMEDIATE "T" POST (ZTP)

Total weight capacity not to exceed 11,000 lbs. per unit (5,500 lbs. per post), based on 24" shelf centers or less.



### HIGH CAPACITY ANGLE POST (SUR)

Total weight capacity not to exceed 13,000 lbs. per unit (3,250 lbs. per post), based on 24" shelf centers or less.

All posts slotted for shelf adjustment on 1/2" centers.

National Motor Freight Class: 50

| CAT. NO.                          | LOAD CAP.* | GA. | LENGTH | WT. | PRICE  |
|-----------------------------------|------------|-----|--------|-----|--------|
| <b>LOW PROFILE SHELF SUPPORTS</b> |            |     |        |     |        |
| DRS-1214 ▲                        | 600        | 14  | 11.5   | 0.5 | \$5.10 |
| DRS-1514 ▲                        | 600        | 14  | 14.5   | 0.7 | 5.80   |
| DRS-1814 ▲                        | 600        | 14  | 17.5   | 0.8 | 6.60   |
| DRS-2414 ▲                        | 600        | 14  | 23.5   | 1.1 | 6.60   |
| DRS-3014 ▲                        | 600        | 14  | 29.5   | 1.4 | 8.00   |
| DRS-3611 ▲                        | 850        | 11  | 35.5   | 2.8 | 15.70  |
| DRS-3614 ▲                        | 600        | 14  | 35.5   | 1.7 | 9.30   |
| DRS-4211 ▲                        | 800        | 11  | 41.5   | 3.2 | 16.90  |
| DRS-4214 ▲                        | 550        | 14  | 41.5   | 2.0 | 10.50  |
| DRS-4811 ▲                        | 750        | 11  | 47.5   | 3.7 | 18.20  |
| DRS-4814 ▲                        | 500        | 14  | 47.5   | 2.3 | 11.70  |

## SHELF SUPPORTS

### LOW PROFILE SHELF SUPPORTS



Profile View



Shelf supports are 27/32" d x 11/8" h.

\*Load capacities are based on evenly distributed loads.

National Motor Freight Class: 70

| CAT. NO.                          | LOAD CAP.* | RECOMMENDED # REINFORCEMENTS | GA. | LENGTH | WT. | PRICE  |
|-----------------------------------|------------|------------------------------|-----|--------|-----|--------|
| <b>MEDIUM DUTY SHELF SUPPORTS</b> |            |                              |     |        |     |        |
| VDRS-1216                         | 1,000      | —                            | 16  | 11.5   | 0.6 | \$5.10 |
| VDRS-1516                         | 1,000      | —                            | 16  | 14.5   | 0.8 | 5.90   |
| VDRS-1816 ▲                       | 1,000      | —                            | 16  | 17.5   | 0.9 | 6.50   |
| VDRS-2416 ▲                       | 1,000      | —                            | 16  | 23.5   | 1.3 | 7.80   |
| VDRS-3016 ▲                       | 1,000      | —                            | 16  | 29.5   | 1.5 | 10.40  |
| VDRS-3616 ▲                       | 1,000      | 1                            | 16  | 35.5   | 1.8 | 11.60  |
| VDRS-4216 ▲                       | 900        | 1                            | 16  | 41.5   | 2.2 | 13.50  |
| VDRS-4814                         | 1,000      | 1                            | 14  | 47.5   | 3.6 | 23.00  |
| VDRS-4816 ▲                       | 850        | 1                            | 16  | 47.5   | 2.5 | 14.40  |
| VDRS-6014 ▲                       | 750        | 1                            | 14  | 59.5   | 4.6 | 27.00  |
| VDRS-6614                         | 700        | 1                            | 14  | 65.5   | 5.0 | 28.00  |
| VDRS-6914 ▲                       | 650        | 2                            | 14  | 68.5   | 5.2 | 30.00  |
| VDRS-7214 ▲                       | 600        | 2                            | 14  | 71.5   | 5.4 | 31.00  |

### MEDIUM DUTY SHELF SUPPORTS



14 Gauge Profile View



16 Gauge Profile View



Supports slotted for optional FBSV-dd front-to-back deck supports. Load capacities are based on recommended number of deck supports.

National Motor Freight Class: 70

### Standard Colors

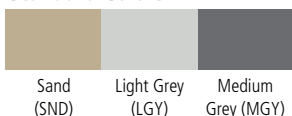

▲ Items with this symbol are available to ship in 2-3 days. Limited quantities and select colors.



## SHELF SUPPORTS

### HEAVY-DUTY SHELF SUPPORTS

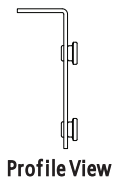

Profile View



Front-to-back shelf supports are 1" d x 2 3/4" h. Load capacities are based on width of shelf. Front-to-back deck supports do not have center rivets for shelf reinforcements.

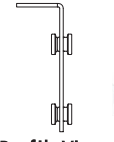

Profile View



Left-to-right shelf supports are 1" d x 2 3/4" h.

### EXTRA HEAVY-DUTY SHELF SUPPORTS

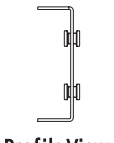

Profile View

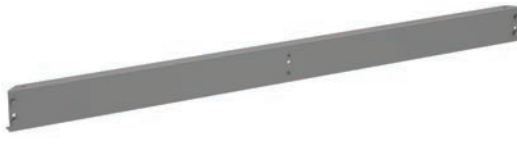

Shelf supports are 1" d x 3 1/4" h.

Use left to right only; not to be used front to back. Cannot be installed in bottom two keyholes of uprights; Will not sit flush on the floor.

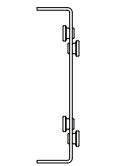

Profile View

### SEISMIC SUPPORT CHANNEL



Shelf supports are 1 1/2" d x 4 13/32" h.

Allows unit to be secured to floor in order to meet seismic requirements.

| CAT. NO.   | LOAD CAP.* | RECOMMENDED # REINFORCEMENTS | GA. | LENGTH | WT.  | PRICE   |
|--|------------|------------------------------|-----|--------|------|---------|
| <b>HEAVY-DUTY SHELF SUPPORTS (Front-to-Back)</b> |            |                              |     |        |      |         |
| LRA-12 ▲   | —          | —                            | 14  | 11.5   | 0.9  | \$6.60  |
| LRA-15 ▲   | —          | —                            | 14  | 14.5   | 1.2  | 8.40    |
| LRA-16   | —          | —                            | 14  | 15.5   | 1.3  | 8.50    |
| LRA-18 ▲   | —          | —                            | 14  | 17.5   | 1.4  | 8.50    |
| LRA-24 ▲   | —          | —                            | 14  | 23.5   | 1.9  | 10.70   |
| LRA-30 ▲   | —          | —                            | 14  | 29.5   | 2.3  | 12.40   |
| LRA-32   | —          | —                            | 14  | 31.5   | 2.5  | 15.10   |
| LRA-36G  | —          | —                            | 14  | 35.5   | 2.8  | 14.90   |
| LRA-42G  | —          | —                            | 14  | 41.5   | 3.3  | 16.60   |
| LRA-48G  | —          | —                            | 14  | 47.5   | 3.7  | 18.80   |
| <b>HEAVY-DUTY SHELF SUPPORTS (Left-to-Right)</b> |            |                              |     |        |      |         |
| LRA-36 ▲   | 2,250      | 1                            | 14  | 35.5   | 2.8  | \$15.10 |
| LRA-42 ▲   | 2,250      | 1                            | 14  | 41.5   | 3.3  | 17.70   |
| LRA-48 ▲   | 2,250      | 1                            | 14  | 47.5   | 3.7  | 19.80   |
| LRA-60 ▲   | 2,000      | 1                            | 14  | 59.5   | 4.7  | 24.00   |
| LRA-69 ▲   | 1,800      | 1                            | 14  | 68.5   | 5.4  | 27.00   |
| LRA-72 ▲   | 1,750      | 2                            | 14  | 71.5   | 5.7  | 31.00   |
| LRA-84 ▲   | 1,500      | 3                            | 14  | 83.5   | 6.6  | 39.00   |
| LRA-96 ▲   | 900        | 3                            | 14  | 95.5   | 7.5  | 43.00   |
| <b>EXTRA HEAVY-DUTY SHELF SUPPORTS</b>           |            |                              |     |        |      |         |
| LRC-48 ▲   | 2,500      | 1                            | 14  | 47.5   | 5.2  | \$25.00 |
| LRC-60   | 2,250      | 1                            | 14  | 59.5   | 6.2  | 32.00   |
| LRC-72 ▲   | 2,000      | 2                            | 14  | 71.5   | 7.4  | 38.00   |
| LRC-84 ▲   | 1,750      | 3                            | 14  | 83.5   | 8.7  | 46.00   |
| LRC-96 ▲   | 1,600      | 3                            | 14  | 95.5   | 9.9  | 50.00   |
| <b>SEISMIC SHELF SUPPORTS</b>                    |            |                              |     |        |      |         |
| SSC-36   | 2,750      | 1                            | 14  | 35.5   | 4.7  | \$30.00 |
| SSC-48   | 2,500      | 1                            | 14  | 47.5   | 6.3  | 36.00   |
| SSC-60   | 2,250      | 1                            | 14  | 59.5   | 7.9  | 46.00   |
| SSC-72   | 2,000      | 2                            | 14  | 71.5   | 9.5  | 51.00   |
| SSC-84   | 1,750      | 3                            | 14  | 83.5   | 11.1 | 59.00   |
| SSC-96   | 1,600      | 3                            | 14  | 95.5   | 12.7 | 69.00   |

\*Load capacities are based on evenly distributed loads with the recommended number of SDS-dd front-to-back deck reinforcements.

National Motor Freight Class: 70

## DECK REINFORCEMENTS

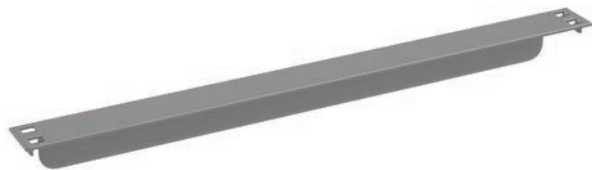

Medium duty provides center reinforcement for decking. Use with VDRS supports.



Heavy duty provides center reinforcement for decking. Use with LRA, LRC or SSC supports.

| CAT. NO.                               | W     | D  | H       | WT. | PRICE  |
|--|-------|----|---------|-----|--------|
| <b>MEDIUM DUTY DECK REINFORCEMENTS</b> |       |    |         |     |        |
| FBSV-12                                | 1 5/8 | 12 | 1 5/8   | 0.6 | \$6.60 |
| FBSV-15 ▲                              | 1 5/8 | 15 | 1 5/8   | 0.8 | 7.00   |
| FBSV-18 ▲                              | 1 5/8 | 18 | 1 5/8   | 0.9 | 7.40   |
| FBSV-24 ▲                              | 1 5/8 | 24 | 1 5/8   | 1.3 | 8.50   |
| FBSV-30 ▲                              | 1 5/8 | 30 | 1 5/8   | 1.6 | 9.70   |
| FBSV-36 ▲                              | 1 5/8 | 36 | 1 5/8   | 1.9 | 11.20  |
| FBSV-42                                | 1 5/8 | 42 | 1 5/8   | 2.2 | 16.20  |
| FBSV-48 ▲                              | 1 5/8 | 48 | 1 5/8   | 2.5 | 18.10  |
| <b>HEAVY DUTY DECK REINFORCEMENTS</b>  |       |    |         |     |        |
| SDS-12 ▲                               | 7/8   | 12 | 2 11/16 | 1.0 | \$5.40 |
| SDS-15 ▲                               | 7/8   | 15 | 2 11/16 | 1.2 | 6.60   |
| SDS-16                                 | 7/8   | 16 | 2 11/16 | 1.3 | 7.40   |
| SDS-18 ▲                               | 7/8   | 18 | 2 11/16 | 1.4 | 7.40   |
| SDS-24 ▲                               | 7/8   | 24 | 2 11/16 | 1.9 | 9.00   |
| SDS-30 ▲                               | 7/8   | 30 | 2 11/16 | 2.4 | 11.10  |
| SDS-32                                 | 7/8   | 32 | 2 11/16 | 2.5 | 12.60  |
| SDS-36 ▲                               | 7/8   | 36 | 2 11/16 | 2.8 | 12.60  |
| SDS-42                                 | 7/8   | 42 | 2 11/16 | 3.3 | 16.50  |
| SDS-48 ▲                               | 7/8   | 48 | 2 11/16 | 3.8 | 16.30  |

National Motor Freight Class: 70

### Standard Colors



▲ Items with this symbol are available to ship in 2-3 days. Limited quantities and select colors.





# Z-Line Components: Decking Options

## PARTICLEBOARD DECKING



Industrial grade 5/8" thick particleboard provides a sturdy work surface that is both strong and economical.

| CAT. NO. | W  | D  | H   | WT.  | PRICE   |
|----------|----|----|-----|------|---------|
| PB-3612  | 36 | 12 | 5/8 | 7.5  | \$15.50 |
| PB-3615  | 36 | 15 | 5/8 | 9.4  | 17.60   |
| PB-3618  | 36 | 18 | 5/8 | 11.3 | 23.00   |
| PB-3624  | 36 | 24 | 5/8 | 15.0 | 31.00   |
| PB-3630  | 36 | 30 | 5/8 | 18.8 | 38.00   |
| PB-3636  | 36 | 36 | 5/8 | 22.5 | 45.00   |
| PB-4212  | 42 | 12 | 5/8 | 8.8  | 19.60   |
| PB-4215  | 42 | 15 | 5/8 | 10.9 | 22.00   |
| PB-4218  | 42 | 18 | 5/8 | 13.1 | 28.00   |
| PB-4224  | 42 | 24 | 5/8 | 17.5 | 38.00   |
| PB-4230  | 42 | 30 | 5/8 | 21.9 | 41.00   |
| PB-4236  | 42 | 36 | 5/8 | 26.3 | 52.00   |
| PB-4812  | 48 | 12 | 5/8 | 10.0 | 21.00   |
| PB-4815  | 48 | 15 | 5/8 | 12.5 | 26.00   |
| PB-4818  | 48 | 18 | 5/8 | 15.0 | 30.00   |
| PB-4824  | 48 | 24 | 5/8 | 20.0 | 40.00   |
| PB-4830  | 48 | 30 | 5/8 | 25.0 | 50.00   |
| PB-4836  | 48 | 36 | 5/8 | 31.0 | 59.00   |
| PB-4842  | 48 | 42 | 5/8 | 35.0 | 97.00   |
| PB-4848  | 48 | 48 | 5/8 | 40.0 | 81.00   |
| PB-6024  | 60 | 24 | 5/8 | 25.0 | 50.00   |
| PB-6030  | 60 | 30 | 5/8 | 31.3 | 63.00   |
| PB-6036  | 60 | 36 | 5/8 | 37.5 | 79.00   |
| PB-6048  | 60 | 48 | 5/8 | 50.0 | 95.00   |
| PB-6915  | 69 | 15 | 5/8 | 18.0 | 38.00   |
| PB-6930  | 69 | 30 | 5/8 | 35.9 | 81.00   |
| PB-7224  | 72 | 24 | 5/8 | 30.0 | 65.00   |
| PB-7230  | 72 | 30 | 5/8 | 37.5 | 79.00   |
| PB-7236  | 72 | 36 | 5/8 | 45.0 | 90.00   |
| PB-7248  | 72 | 48 | 5/8 | 60.0 | 119.00  |
| PB-8424  | 84 | 24 | 5/8 | 35.0 | 81.00   |
| PB-8430  | 84 | 30 | 5/8 | 50.0 | 97.00   |
| PB-8436  | 84 | 36 | 5/8 | 52.5 | 119.00  |
| PB-8448  | 84 | 48 | 5/8 | 70.0 | 158.00  |
| PB-9624  | 96 | 24 | 5/8 | 40.0 | 81.00   |
| PB-9630  | 96 | 30 | 5/8 | 50.0 | 97.00   |
| PB-9636  | 96 | 36 | 5/8 | 60.0 | 119.00  |
| PB-9648  | 96 | 48 | 5/8 | 80.0 | 158.00  |

Available in Natural only.  
National Motor Freight Class: 55

## STEEL SHELVES

Attaches to upright posts with four shelf clips per shelf (included). Shelf clips allow for access from all four sides of the unit.

NOTE: When building your own unit with steel shelves, you MUST use VDRS supports at the top and bottom of the unit, on all four sides for stabilization. Shelf clips alone are NOT sufficient to stabilize unit.

In addition, units 96" and taller must use VDRS supports in the center of the unit, on all four sides.

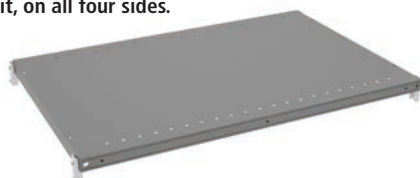

Shelf Clip

### Standard Colors (Unless Otherwise Specified)



## WIRE DECKING

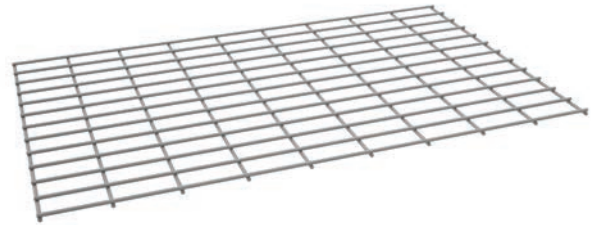

Wire decking uses 5 gauge wire & consists of a 2" x 4" mesh pattern. Additional sizes are available; contact factory for pricing. Wire decking is subject to longer than normal lead times; contact factory for specifics.

Not recommended for shelf levels with DRS supports deeper than 24".

| CAT. NO.  | W  | D  | H    | WT.  | PRICE   |
|-----------|----|----|------|------|---------|
| ZWD-3612  | 36 | 12 | 5/16 | 4.0  | \$54.00 |
| ZWD-3618  | 36 | 18 | 5/16 | 6.0  | 65.00   |
| ZWD-3624  | 36 | 24 | 5/16 | 8.0  | 73.00   |
| ZWD-3636  | 36 | 36 | 5/16 | 12.0 | 89.00   |
| ZWD-4218  | 42 | 18 | 5/16 | 7.1  | 89.00   |
| ZWD-4224  | 42 | 24 | 5/16 | 9.3  | 90.00   |
| ZWD-4230  | 42 | 30 | 5/16 | 11.7 | 112.00  |
| ZWD-4236  | 42 | 36 | 5/16 | 14.2 | 107.00  |
| ZWD-4812  | 48 | 12 | 5/16 | 5.4  | 57.00   |
| ZWD-4815  | 48 | 15 | 5/16 | 7.0  | 85.00   |
| ZWD-4818  | 48 | 18 | 5/16 | 8.0  | 70.00   |
| ZWD-4824  | 48 | 24 | 5/16 | 10.7 | 85.00   |
| ZWD-4836  | 48 | 36 | 5/16 | 16.0 | 116.00  |
| ZWD-4848  | 48 | 48 | 5/16 | 21.0 | 149.00  |
| ZWD-6030  | 60 | 30 | 5/16 | 13.3 | 153.00  |
| ZWD-6036  | 60 | 36 | 5/16 | 20.0 | 153.00  |
| ZWD-6048  | 60 | 48 | 5/16 | 27.0 | 211.00  |
| ZWD-6930  | 69 | 30 | 5/16 | 19.2 | 132.00  |
| ZWD-7224  | 72 | 24 | 5/16 | 16.0 | 131.00  |
| ZWD-7236  | 72 | 36 | 5/16 | 24.0 | 161.00  |
| ZWD-7248  | 72 | 48 | 5/16 | 32.0 | 190.00  |
| ZWD-8424* | 84 | 24 | 5/16 | 19.0 | 154.00  |
| ZWD-8436* | 84 | 36 | 5/16 | 28.0 | 193.00  |
| ZWD-8448* | 84 | 48 | 5/16 | 37.0 | 230.00  |
| ZWD-9624* | 96 | 24 | 5/16 | 21.0 | 170.00  |
| ZWD-9636* | 96 | 36 | 5/16 | 32.0 | 232.00  |
| ZWD-9648* | 96 | 48 | 5/16 | 42.0 | 298.00  |

\*84" w and 96" w are shipped as two pieces and should be tied together with zip ties.

NOTE: Price shown is for Medium Grey. For price of Sand or Light Grey, add a 10% upcharge.

National Motor Freight Class: 70

| CAT. NO.                       | Load Cap. | W  | D  | H      | WT.  | PRICE    |
|--------------------------------|-----------|----|----|--------|------|----------|
| <b>22 Gauge</b>                |           |    |    |        |      |          |
| ZMS-3612                       | 750       | 36 | 12 | 1 5/16 | 6.7  | \$44.00  |
| ZMS-3618                       | 750       | 36 | 18 | 1 5/16 | 8.8  | 54.00    |
| ZMS-3624                       | 700       | 36 | 24 | 1 5/16 | 10.9 | 64.00    |
| ZMS-4212                       | 600       | 42 | 12 | 1 5/16 | 7.7  | 54.00    |
| ZMS-4218                       | 600       | 42 | 18 | 1 5/16 | 7.7  | 62.00    |
| ZMS-4224                       | 550       | 42 | 24 | 1 5/16 | 10.1 | 74.00    |
| ZMS-4812                       | 500       | 48 | 12 | 1 5/16 | 8.7  | 52.00    |
| ZMS-4818                       | 500       | 48 | 18 | 1 5/16 | 11.4 | 67.00    |
| ZMS-4824                       | 450       | 48 | 24 | 1 5/16 | 14.1 | 78.00    |
| <b>20 Gauge</b>                |           |    |    |        |      |          |
| ZMS-3636                       | 600       | 36 | 36 | 1 5/16 | 17.9 | \$119.00 |
| ZMS-4236                       | 550       | 42 | 36 | 1 5/16 | 21.0 | 130.00   |
| ZMS-4836                       | 450       | 48 | 36 | 1 5/16 | 23.0 | 143.00   |
| <b>REPLACEMENT SHELF CLIPS</b> |           |    |    |        |      |          |
| ZSC-1                          | —         | —  | —  | —      | 0.1  | \$1.50   |

National Motor Freight Class: 70

■ ♣ ▼  
 Items with these symbols are available to ship in 2-3 days. Limited quantities and select colors.



SHELVING

# Z-Line Components: Accessories

## SIDE AND BACK PANELS

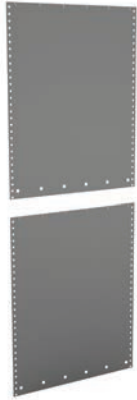

**BACK PANEL**  
Back panels fit units with EUR and ZTP posts. Back consists of two pieces. Includes 10 attachment clips. Other sizes available; contact factory.



**SIDE PANEL**  
Side panels fit starter units with EUR posts only. Side consists of two pieces. Includes 10 attachment clips. Other sizes available; contact factory.

| CAT. NO.                | W  | D  | H  | WT.  | PRICE    |
|-------------------------|----|----|----|------|----------|
| <b>SIDE PANELS</b>      |    |    |    |      |          |
| ZLEP-1284               | —  | 12 | 84 | 11.5 | \$110.00 |
| ZLEP-1584               | —  | 15 | 84 | 14.0 | 114.00   |
| ZLEP-1884               | —  | 18 | 84 | 16.6 | 127.00   |
| ZLEP-2484               | —  | 24 | 84 | 22.0 | 150.00   |
| ZLEP-3084               | —  | 30 | 84 | 27.0 | 291.00   |
| <b>BACK PANELS</b>      |    |    |    |      |          |
| ZLBP-3684               | 36 | —  | 84 | 35.0 | \$225.00 |
| ZLBP-4284               | 42 | —  | 84 | 42.0 | 239.00   |
| ZLBP-4884               | 48 | —  | 84 | 48.0 | 260.00   |
| <b>CLIPS FOR PANELS</b> |    |    |    |      |          |
| Z-CLIP*                 | —  | —  | —  | 0.1  | \$2.40   |

\*Zinc plated.

National Motor Freight Class: 70

## SHELF DIVIDER

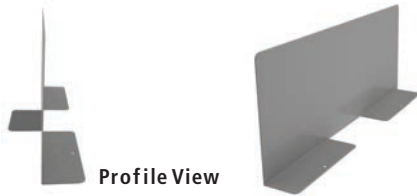

Profile View

| CAT. NO. | W | D  | H  | WT. | PRICE   |
|----------|---|----|----|-----|---------|
| DIV2410  | — | 24 | 10 | 4.4 | \$31.00 |

Use on particleboard, front-to-back, to subdivide shelf into several storage areas.

National Motor Freight Class: 70

## CASTER KITS

Load capacity for caster kit is 1,000 lbs. Casters should not be used with units over 96" tall, or on units less than 18" deep. Maximum unit size is 60" wide by 30" deep.



| CAT. NO. | CASTERS           | W      | D     | H    | WT.  | PRICE    |
|----------|-------------------|--------|-------|------|------|----------|
| ZLCK-1   | 2 Fixed, 2 Swivel | 1 1/2  | 1 1/2 | 7/16 | 12.8 | \$231.00 |
| ZLCK-2   | 4 Swivel          | 3 7/16 | 2     | 7/16 | 13.0 | 235.00   |

National Motor Freight Class: 70

## HANG RODS

Used for hanging items left-to-right on a Z-Line unit. Attaches between two LRA shelf supports.



| CAT. NO.                        | LOAD CAP. | W      | D      | H      | WT. | PRICE   |
|---------------------------------|-----------|--------|--------|--------|-----|---------|
| <b>FOR LRA OR LRC SUPPORTS</b>  |           |        |        |        |     |         |
| <b>Channel-Shaped Hang Rods</b> |           |        |        |        |     |         |
| PHR-36♣                         | 150       | 36 1/4 | 1 5/16 | 1 1/16 | 2.9 | \$14.60 |
| PHR-48♣                         | 150       | 48 1/4 | 1 5/16 | 1 1/16 | 3.8 | 18.50   |

National Motor Freight Class: 70

## PROTECTIVE CAPS

Place top edge caps over top of uprights to protect from sharp edges. Place foot caps beneath uprights as a floor protector.



Hard Nylon Foot Caps

Soft Top Edge Caps

| CAT. NO.                    | Use With     | W      | D     | H    | WT. | PRICE  |
|-----------------------------|--------------|--------|-------|------|-----|--------|
| <b>SOFT TOP EDGE CAPS</b>   |              |        |       |      |     |        |
| EURPC •                     | EUR Uprights | 1 1/2  | 1 1/2 | 7/16 | 0.1 | \$1.50 |
| ZTPPC •                     | ZTP Uprights | 3 7/16 | 2     | 7/16 | 0.1 | 2.40   |
| SURPC •                     | SUR Uprights | 2 3/4  | 2 3/4 | 7/16 | 0.1 | 1.10   |
| <b>HARD NYLON FOOT CAPS</b> |              |        |       |      |     |        |
| EURNF •                     | EUR Uprights | 1 1/2  | 1 1/2 | 3/4  | 0.1 | \$1.40 |
| ZTPNF •                     | ZTP Uprights | 3 7/16 | 2     | 3/4  | 0.2 | 2.70   |
| SURNF •                     | SUR Uprights | 2 1/4  | 2 1/4 | 3/4  | 0.2 | 2.00   |

Available in Black only.

National Motor Freight Class: 70

### Standard Colors (Unless Otherwise Specified)



♣ •  
Items with these symbols are available to ship in 2-3 days. Limited quantities and select colors.

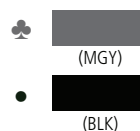

# Z-Line Components: Accessories

## CROSS AISLE TIES

| CAT. NO. | W     | D  | H     | WT. | PRICE   |
|----------|-------|----|-------|-----|---------|
| CAT-18♣  | 1 3/8 | 18 | 2 3/8 | 1.4 | \$16.10 |
| CAT-24   | 1 3/8 | 24 | 2 3/8 | 1.9 | 19.70   |
| CAT-30   | 1 3/8 | 30 | 2 3/8 | 2.4 | 23.00   |
| CAT-36♣  | 1 3/8 | 36 | 2 3/8 | 2.8 | 23.00   |
| CAT-42   | 1 3/8 | 42 | 2 3/8 | 3.3 | 27.00   |
| CAT-48   | 1 3/8 | 48 | 2 3/8 | 3.8 | 34.00   |

Used to link across an aisle for extra stability.  
National Motor Freight Class: 70

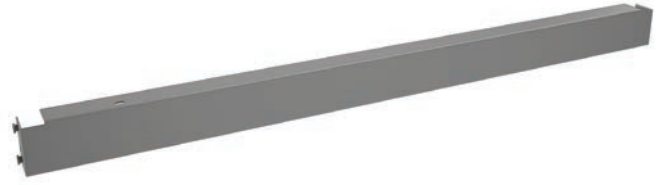

## ADJUSTABLE AISLE TIE

| CAT. NO. | W | D | H | WT. | PRICE   |
|----------|---|---|---|-----|---------|
| KCAT-1   | 3 | * | 1 | 6.0 | \$53.00 |

\*Depth adjusts from 36" to 60"

Links units across an aisle at adjustable distances.  
National Motor Freight Class: 70



## POST SPLICE ANGLE

| CAT. NO. | W      | D      | H     | WT. | PRICE   |
|----------|--------|--------|-------|-----|---------|
| PSA-2    | 1 9/16 | 1 9/16 | 6 1/2 | 1.1 | \$14.60 |

National Motor Freight Class: 70



Includes hardware. Used for splicing EUR, SUR and ZTP upright posts. When splicing ZTP uprights, two post splice angles are required per post.

## WALL TIE

| CAT. NO. | W     | D     | H     | WT. | PRICE  |
|----------|-------|-------|-------|-----|--------|
| WT-9♣    | 9 1/4 | 1 3/8 | 2 3/8 | .7  | \$6.80 |

National Motor Freight Class: 70



Used to secure a unit to a wall, with a 9" gap between the unit and the wall.

## TIE PLATE

| CAT. NO. | W | D | H     | WT. | PRICE  |
|----------|---|---|-------|-----|--------|
| TP-1▲    | 3 | — | 2 3/4 | .2  | \$2.70 |

National Motor Freight Class: 70



Used to secure two angle posts together front-to-back or side-by-side.

## ANCHOR PLATE

| CAT. NO. | W     | D     | H     | WT. | PRICE  |
|----------|-------|-------|-------|-----|--------|
| ZFA-1▲   | 1 3/8 | 1 1/2 | 2 3/8 | .2  | \$4.70 |

National Motor Freight Class: 70



Attaches to uprights to allow anchoring uprights to the floor.

## FOOT PLATES

| CAT. NO. | W     | D     | H     | WT. | PRICE  |
|----------|-------|-------|-------|-----|--------|
| ZFP-L♣   | 1 3/8 | 1 1/2 | 2 3/8 | .2  | \$3.20 |
| ZFP-R♣   | 1 3/8 | 1 1/2 | 2 3/8 | .2  | \$3.20 |
| DZFP♣    | 2 3/4 | 1 1/2 | 2 3/8 | .5  | \$6.60 |

National Motor Freight Class: 70



Attaches to uprights to allow anchoring uprights to the floor.

### Standard Colors



♣ ▲  
Items with these symbols are available to ship in 2-3 days. Limited quantities and select colors.

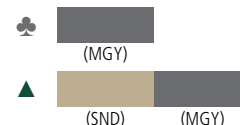

# Bulk Storage Racks

## BULK STORAGE RACKS - 24" DEEP

\*Load capacities are based on evenly distributed loads.



STARTER



ADDER

\*\*Wire Decking available in Medium Grey only.

National Motor Freight Class: 70

Units are intended to be hand loaded only.

| UNIT SIZE                    |    |     | SHELF LOAD CAPACITY* | REINFORCEMENTS PER LEVEL | STARTER UNITS |     |          | ADDER UNITS  |     |          | EXTRA SHELF LEVEL |      |          |
|------------------------------|----|-----|----------------------|--------------------------|---------------|-----|----------|--------------|-----|----------|-------------------|------|----------|
| W                            | D  | H   |                      |                          | CAT NO.       | WT. | PRICE    | CAT NO.      | WT. | PRICE    | CAT NO.           | WT.  | PRICE    |
| <b>Particleboard Decking</b> |    |     |                      |                          |               |     |          |              |     |          |                   |      |          |
| 48                           | 24 | 72  | 4,150                | 2                        | BU-482472PS   | 154 | \$660.00 | BU-482472PA  | 134 | \$537.00 | BU-4824P          | 38.0 | \$138.00 |
| 72                           | 24 | 72  | 2,750                | 3                        | BU-722472PS   | 205 | 837.00   | BU-722472PA  | 185 | 714.00   | BU-7224P          | 55.0 | 197.00   |
| 96                           | 24 | 72  | 2,150                | 4                        | BU-962472PS   | 262 | 993.00   | BU-962472PA  | 242 | 870.00   | BU-9624P          | 74.0 | 249.00   |
| 48                           | 24 | 84  | 4,150                | 2                        | BU-482484PS   | 162 | 750.00   | BU-482484PA  | 138 | 582.00   | BU-4824P          | 38.0 | 138.00   |
| 72                           | 24 | 84  | 2,750                | 3                        | BU-722484PS   | 213 | 927.00   | BU-722484PA  | 189 | 759.00   | BU-7224P          | 55.0 | 197.00   |
| 96                           | 24 | 84  | 2,150                | 4                        | BU-962484PS   | 270 | 1,083.00 | BU-962484PA  | 246 | 915.00   | BU-9624P          | 74.0 | 249.00   |
| 48                           | 24 | 96  | 4,150                | 2                        | BU-482496PS   | 170 | 742.00   | BU-482496PA  | 142 | 578.00   | BU-4824P          | 38.0 | 138.00   |
| 72                           | 24 | 96  | 2,750                | 3                        | BU-722496PS   | 221 | 919.00   | BU-722496PA  | 193 | 755.00   | BU-7224P          | 55.0 | 197.00   |
| 96                           | 24 | 96  | 2,150                | 4                        | BU-962496PS   | 278 | 1,075.00 | BU-962496PA  | 250 | 911.00   | BU-9624P          | 74.0 | 249.00   |
| 48                           | 24 | 120 | 4,150                | 2                        | BU-4824120PS  | 180 | 814.00   | BU-4824120PA | 147 | 614.00   | BU-4824P          | 38.0 | 138.00   |
| 72                           | 24 | 120 | 2,750                | 3                        | BU-7224120PS  | 231 | 991.00   | BU-7224120PA | 198 | 791.00   | BU-7224P          | 55.0 | 197.00   |
| 96                           | 24 | 120 | 2,150                | 4                        | BU-9624120PS  | 288 | 1,147.00 | BU-9624120PA | 255 | 947.00   | BU-9624P          | 74.0 | 249.00   |
| <b>Corrugated Decking</b>    |    |     |                      |                          |               |     |          |              |     |          |                   |      |          |
| 48                           | 24 | 72  | 4,150                | 2                        | BU-482472CS   | 136 | \$795.00 | BU-482472CA  | 116 | \$672.00 | BU-4824C          | 32.0 | \$183.00 |
| 72                           | 24 | 72  | 2,750                | 3                        | BU-722472CS   | 178 | 1,011.00 | BU-722472CA  | 158 | 888.00   | BU-7224C          | 46.0 | 255.00   |
| 96                           | 24 | 72  | 2,150                | 4                        | BU-962472CS   | 226 | 1,224.00 | BU-962472CA  | 206 | 1,101.00 | BU-9624C          | 62.0 | 326.00   |
| 48                           | 24 | 84  | 4,150                | 2                        | BU-482484CS   | 144 | 885.00   | BU-482484CA  | 120 | 717.00   | BU-4824C          | 32.0 | 183.00   |
| 72                           | 24 | 84  | 2,750                | 3                        | BU-722484CS   | 186 | 1,101.00 | BU-722484CA  | 162 | 933.00   | BU-7224C          | 46.0 | 255.00   |
| 96                           | 24 | 84  | 2,150                | 4                        | BU-962484CS   | 234 | 1,314.00 | BU-962484CA  | 210 | 1,146.00 | BU-9624C          | 62.0 | 326.00   |
| 48                           | 24 | 96  | 4,150                | 2                        | BU-482496CS   | 152 | 877.00   | BU-482496CA  | 124 | 713.00   | BU-4824C          | 32.0 | 183.00   |
| 72                           | 24 | 96  | 2,750                | 3                        | BU-722496CS   | 194 | 1,093.00 | BU-722496CA  | 166 | 929.00   | BU-7224C          | 46.0 | 255.00   |
| 96                           | 24 | 96  | 2,150                | 4                        | BU-962496CS   | 242 | 1,306.00 | BU-962496CA  | 214 | 1,142.00 | BU-9624C          | 62.0 | 326.00   |
| 48                           | 24 | 120 | 4,150                | 2                        | BU-4824120CS  | 162 | 949.00   | BU-4824120CA | 129 | 749.00   | BU-4824C          | 32.0 | 183.00   |
| 72                           | 24 | 120 | 2,750                | 3                        | BU-7224120CS  | 204 | 1,165.00 | BU-7224120CA | 171 | 965.00   | BU-7224C          | 46.0 | 255.00   |
| 96                           | 24 | 120 | 2,150                | 4                        | BU-9624120CS  | 252 | 1,378.00 | BU-9624120CA | 219 | 1,178.00 | BU-9624C          | 62.0 | 326.00   |
| <b>Wire Decking**</b>        |    |     |                      |                          |               |     |          |              |     |          |                   |      |          |
| 48                           | 24 | 72  | 4,150                | 2                        | BU-482472WS   | 126 | \$795.00 | BU-482472WA  | 106 | \$672.00 | BU-4824W          | 29.0 | \$183.00 |
| 72                           | 24 | 72  | 2,750                | 3                        | BU-722472WS   | 163 | 1,035.00 | BU-722472WA  | 143 | 912.00   | BU-7224W          | 41.0 | 263.00   |
| 96                           | 24 | 72  | 2,150                | 4                        | BU-962472WS   | 206 | 1,260.00 | BU-962472WA  | 186 | 1,137.00 | BU-9624W          | 55.0 | 338.00   |
| 48                           | 24 | 84  | 4,150                | 2                        | BU-482484WS   | 134 | 885.00   | BU-482484WA  | 110 | 717.00   | BU-4824W          | 29.0 | 183.00   |
| 72                           | 24 | 84  | 2,750                | 3                        | BU-722484WS   | 171 | 1,125.00 | BU-722484WA  | 147 | 957.00   | BU-7224W          | 41.0 | 263.00   |
| 96                           | 24 | 84  | 2,150                | 4                        | BU-962484WS   | 213 | 1,350.00 | BU-962484WA  | 189 | 1,182.00 | BU-9624W          | 55.0 | 338.00   |
| 48                           | 24 | 96  | 4,150                | 2                        | BU-482496WS   | 142 | 877.00   | BU-482496WA  | 114 | 713.00   | BU-4824W          | 29.0 | 183.00   |
| 72                           | 24 | 96  | 2,750                | 3                        | BU-722496WS   | 179 | 1,117.00 | BU-722496WA  | 151 | 953.00   | BU-7224W          | 41.0 | 263.00   |
| 96                           | 24 | 96  | 2,150                | 4                        | BU-962496WS   | 222 | 1,342.00 | BU-962496WA  | 194 | 1,178.00 | BU-9624W          | 55.0 | 338.00   |
| 48                           | 24 | 120 | 4,150                | 2                        | BU-4824120WS  | 152 | 949.00   | BU-4824120WA | 119 | 749.00   | BU-4824W          | 29.0 | 183.00   |
| 72                           | 24 | 120 | 2,750                | 3                        | BU-7224120WS  | 189 | 1,189.00 | BU-7224120WA | 156 | 989.00   | BU-7224W          | 41.0 | 263.00   |
| 96                           | 24 | 120 | 2,150                | 4                        | BU-9624120WS  | 232 | 1,414.00 | BU-9624120WA | 199 | 1,214.00 | BU-9624W          | 55.0 | 338.00   |

- Assembly required.

Standard Colors (Unless Otherwise Specified)



☛ Items with this symbol are available to ship in 2-3 days. ☛ Limited quantities and select colors. (MGY)

# Bulk Storage Racks

## BULK STORAGE RACKS - 36" DEEP

\*Load capacities are based on evenly distributed loads.

\*\*Wire Decking available in Medium Grey only.

National Motor Freight Class: 70

Units are intended to be hand loaded only.

To reach 4,150 lbs. shelf level capacity on 48" wide units, two additional BPS are required. Must be purchased separately.



STARTER



ADDER

| UNIT SIZE<br>W D H           | SHELF LOAD<br>CAPACITY* | REINFORCEMENTS<br>PER LEVEL | STARTER UNITS |     |          | ADDER UNITS   |     |          | EXTRA SHELF LEVEL |      |          |
|------------------------------|-------------------------|-----------------------------|---------------|-----|----------|---------------|-----|----------|-------------------|------|----------|
|                              |                         |                             | CAT NO.       | WT. | PRICE    | CAT NO.       | WT. | PRICE    | CAT NO.           | WT.  | PRICE    |
| <b>Particleboard Decking</b> |                         |                             |               |     |          |               |     |          |                   |      |          |
| 48 36 72                     | 3,000                   | 2                           | BU-483672PS♣  | 193 | \$758.00 | BU-483672PA♣  | 171 | \$625.00 | BU-4836P♣         | 50.0 | \$164.00 |
| 72 36 72                     | 2,750                   | 3                           | BU-723672PS♣  | 260 | 953.00   | BU-723672PA♣  | 238 | 820.00   | BU-7236P♣         | 72.0 | 229.00   |
| 96 36 72                     | 2,150                   | 4                           | BU-963672PS♣  | 335 | 1,160.00 | BU-963672PA♣  | 313 | 1,027.00 | BU-9636P♣         | 97.0 | 298.00   |
| 48 36 84                     | 3,000                   | 2                           | BU-483684PS♣  | 198 | 850.00   | BU-483684PA♣  | 173 | 701.00   | BU-4836P♣         | 50.0 | 164.00   |
| 72 36 84                     | 2,750                   | 3                           | BU-723684PS♣  | 266 | 1,045.00 | BU-723684PA♣  | 241 | 866.00   | BU-7236P♣         | 72.0 | 229.00   |
| 96 36 84                     | 2,150                   | 4                           | BU-963684PS♣  | 341 | 1,252.00 | BU-963684PA♣  | 316 | 1,073.00 | BU-9636P♣         | 97.0 | 298.00   |
| 48 36 96                     | 3,000                   | 2                           | BU-483696PS♣  | 209 | 858.00   | BU-483696PA♣  | 179 | 675.00   | BU-4836P♣         | 50.0 | 164.00   |
| 72 36 96                     | 2,750                   | 3                           | BU-723696PS♣  | 276 | 1,053.00 | BU-723696PA♣  | 246 | 870.00   | BU-7236P♣         | 72.0 | 229.00   |
| 96 36 96                     | 2,150                   | 4                           | BU-963696PS♣  | 351 | 1,260.00 | BU-963696PA♣  | 321 | 1,077.00 | BU-9636P♣         | 97.0 | 298.00   |
| 48 36 120                    | 3,000                   | 2                           | BU-4836120PS♣ | 221 | 924.00   | BU-4836120PA♣ | 185 | 708.00   | BU-4836P♣         | 50.0 | 164.00   |
| 72 36 120                    | 2,750                   | 3                           | BU-7236120PS♣ | 288 | 1,119.00 | BU-7236120PA♣ | 252 | 903.00   | BU-7236P♣         | 72.0 | 229.00   |
| 96 36 120                    | 2,150                   | 4                           | BU-9636120PS♣ | 363 | 1,326.00 | BU-9636120PA♣ | 327 | 1,110.00 | BU-9636P♣         | 97.0 | 298.00   |
| <b>Corrugated Decking</b>    |                         |                             |               |     |          |               |     |          |                   |      |          |
| 48 36 72                     | 3,000                   | 2                           | BU-483672CS♣  | 163 | \$956.00 | BU-483672CA♣  | 141 | \$823.00 | BU-4836C♣         | 40.0 | \$230.00 |
| 72 36 72                     | 2,750                   | 3                           | BU-723672CS♣  | 218 | 1,217.00 | BU-723672CA♣  | 196 | 1,084.00 | BU-7236C♣         | 58.0 | 317.00   |
| 96 36 72                     | 2,150                   | 4                           | BU-963672CS♣  | 275 | 1,493.00 | BU-963672CA♣  | 253 | 1,360.00 | BU-9636C♣         | 77.0 | 409.00   |
| 48 36 84                     | 3,000                   | 2                           | BU-483684CS♣  | 168 | 1,108.00 | BU-483684CA♣  | 143 | 869.00   | BU-4836C♣         | 40.0 | 230.00   |
| 72 36 84                     | 2,750                   | 3                           | BU-723684CS♣  | 224 | 1,309.00 | BU-723684CA♣  | 199 | 1,130.00 | BU-7236C♣         | 58.0 | 317.00   |
| 96 36 84                     | 2,150                   | 4                           | BU-963684CS♣  | 281 | 1,585.00 | BU-963684CA♣  | 256 | 1,406.00 | BU-9636C♣         | 77.0 | 409.00   |
| 48 36 96                     | 3,000                   | 2                           | BU-483696CS♣  | 179 | 1,056.00 | BU-483696CA♣  | 149 | 873.00   | BU-4836C♣         | 40.0 | 230.00   |
| 72 36 96                     | 2,750                   | 3                           | BU-723696CS♣  | 234 | 1,317.00 | BU-723696CA♣  | 204 | 1,134.00 | BU-7236C♣         | 58.0 | 317.00   |
| 96 36 96                     | 2,150                   | 4                           | BU-963696CS♣  | 291 | 1,593.00 | BU-963696CA♣  | 261 | 1,410.00 | BU-9636C♣         | 77.0 | 409.00   |
| 48 36 120                    | 3,000                   | 2                           | BU-4836120CS♣ | 191 | 1,122.00 | BU-4836120CA♣ | 155 | 906.00   | BU-4836C♣         | 40.0 | 230.00   |
| 72 36 120                    | 2,750                   | 3                           | BU-7236120CS♣ | 246 | 1,383.00 | BU-7236120CA♣ | 210 | 1,167.00 | BU-7236C♣         | 58.0 | 317.00   |
| 96 36 120                    | 2,150                   | 4                           | BU-9636120CS♣ | 303 | 1,659.00 | BU-9636120CA♣ | 267 | 1,443.00 | BU-9636C♣         | 77.0 | 409.00   |
| <b>Wire Decking**</b>        |                         |                             |               |     |          |               |     |          |                   |      |          |
| 48 36 72                     | 3,000                   | 2                           | BU-483672WS♣  | 148 | \$929.00 | BU-483672WA♣  | 126 | \$796.00 | BU-4836W♣         | 35.0 | \$221.00 |
| 72 36 72                     | 2,750                   | 3                           | BU-723672WS♣  | 197 | 1,166.00 | BU-723672WA♣  | 175 | 1,033.00 | BU-7236W♣         | 51.0 | 300.00   |
| 96 36 72                     | 2,150                   | 4                           | BU-963672WS♣  | 251 | 1,499.00 | BU-963672WA♣  | 229 | 1,366.00 | BU-9636W♣         | 69.0 | 411.00   |
| 48 36 84                     | 3,000                   | 2                           | BU-483684WS♣  | 153 | 1,021.00 | BU-483684WA♣  | 128 | 842.00   | BU-4836W♣         | 35.0 | 221.00   |
| 72 36 84                     | 2,750                   | 3                           | BU-723684WS♣  | 203 | 1,258.00 | BU-723684WA♣  | 178 | 1,079.00 | BU-7236W♣         | 51.0 | 300.00   |
| 96 36 84                     | 2,150                   | 4                           | BU-963684WS♣  | 257 | 1,591.00 | BU-963684WA♣  | 232 | 1,419.00 | BU-9636W♣         | 69.0 | 411.00   |
| 48 36 96                     | 3,000                   | 2                           | BU-483696WS♣  | 164 | 1,029.00 | BU-483696WA♣  | 134 | 846.00   | BU-4836W♣         | 35.0 | 221.00   |
| 72 36 96                     | 2,750                   | 3                           | BU-723696WS♣  | 213 | 1,266.00 | BU-723696WA♣  | 183 | 1,083.00 | BU-7236W♣         | 51.0 | 300.00   |
| 96 36 96                     | 2,150                   | 4                           | BU-963696WS♣  | 267 | 1,599.00 | BU-963696WA♣  | 237 | 1,416.00 | BU-9636W♣         | 69.0 | 411.00   |
| 48 36 120                    | 3,000                   | 2                           | BU-4836120WS♣ | 176 | 1,095.00 | BU-4836120WA♣ | 140 | 879.00   | BU-4836W♣         | 35.0 | 221.00   |
| 72 36 120                    | 2,750                   | 3                           | BU-7236120WS♣ | 225 | 1,332.00 | BU-7236120WA♣ | 189 | 1,116.00 | BU-7236W♣         | 51.0 | 300.00   |
| 96 36 120                    | 2,150                   | 4                           | BU-9636120WS♣ | 279 | 1,665.00 | BU-9636120WA♣ | 243 | 1,449.00 | BU-9636W♣         | 69.0 | 411.00   |

- Assembly required.

### Standard Colors (Unless Otherwise Specified)



♣ Items with this symbol are available to ship in 2-3 days. Limited quantities and select colors. (MGY)

# Bulk Storage Racks

## BULK STORAGE RACKS - 48" DEEP

\*Load capacities are based on evenly distributed loads.



STARTER



ADDER

\*\*Wire Decking available in Medium Grey only.

National Motor Freight Class: 70

Units are intended to be hand loaded only.

To reach 4,150 lbs. shelf level capacity on 48" wide units, two additional BPS are required. Must be purchased separately.

| UNIT SIZE<br>W D H           | SHELF LOAD<br>CAPACITY* | REINFORCEMENTS<br>PER LEVEL | STARTER UNITS |     |            | ADDER UNITS   |     |          | EXTRA SHELF LEVEL |       |          |
|------------------------------|-------------------------|-----------------------------|---------------|-----|------------|---------------|-----|----------|-------------------|-------|----------|
|                              |                         |                             | CAT NO.       | WT. | PRICE      | CAT NO.       | WT. | PRICE    | CAT NO.           | WT.   | PRICE    |
| <b>Particleboard Decking</b> |                         |                             |               |     |            |               |     |          |                   |       |          |
| 48 48 72                     | 1,500                   | 2                           | BU-484872PS♣  | 229 | \$873.00   | BU-484872PA♣  | 206 | \$726.00 | BU-4848P♣         | 61.0  | \$193.00 |
| 72 48 72                     | 2,750                   | 3                           | BU-724872PS♣  | 319 | 1,110.00   | BU-724872PA♣  | 296 | 963.00   | BU-7248P♣         | 91.0  | 272.00   |
| 96 48 72                     | 2,150                   | 4                           | BU-964872PS♣  | 397 | 1,359.00   | BU-964872PA♣  | 374 | 1,047.00 | BU-9648P♣         | 117.0 | 355.00   |
| 48 48 84                     | 1,500                   | 2                           | BU-484884PS♣  | 237 | 997.00     | BU-484884PA♣  | 210 | 788.00   | BU-4848P♣         | 61.0  | 193.00   |
| 72 48 84                     | 2,750                   | 3                           | BU-724884PS♣  | 327 | 1,234.00   | BU-724884PA♣  | 300 | 1,016.00 | BU-7248P♣         | 91.0  | 272.00   |
| 96 48 84                     | 2,150                   | 4                           | BU-964884PS♣  | 405 | 1,483.00   | BU-964884PA♣  | 378 | 1,274.00 | BU-9648P♣         | 117.0 | 355.00   |
| 48 48 96                     | 1,500                   | 2                           | BU-484896PS♣  | 249 | 979.00     | BU-484896PA♣  | 216 | 779.00   | BU-4848P♣         | 61.0  | 193.00   |
| 72 48 96                     | 2,750                   | 3                           | BU-724896PS♣  | 339 | 1,216.00   | BU-724896PA♣  | 306 | 1,016.00 | BU-7248P♣         | 91.0  | 272.00   |
| 96 48 96                     | 2,150                   | 4                           | BU-964896PS♣  | 417 | 1,465.00   | BU-964896PA♣  | 384 | 1,265.00 | BU-9648P♣         | 117.0 | 355.00   |
| 48 48 120                    | 1,500                   | 2                           | BU-4848120PS♣ | 259 | 1,047.00   | BU-4848120PA♣ | 221 | 813.00   | BU-4848P♣         | 61.0  | 193.00   |
| 72 48 120                    | 2,750                   | 3                           | BU-7248120PS♣ | 349 | 1,284.00   | BU-7248120PA♣ | 311 | 1,050.00 | BU-7248P♣         | 91.0  | 272.00   |
| 96 48 120                    | 2,150                   | 4                           | BU-9648120PS♣ | 427 | 1,533.00   | BU-9648120PA♣ | 389 | 1,299.00 | BU-9648P♣         | 117.0 | 355.00   |
| <b>Corrugated Decking</b>    |                         |                             |               |     |            |               |     |          |                   |       |          |
| 48 48 72                     | 1,500                   | 2                           | BU-484872CS♣  | 193 | \$1,092.00 | BU-484872CA♣  | 170 | 945.00   | BU-4848C♣         | 49.0  | \$266.00 |
| 72 48 72                     | 2,750                   | 3                           | BU-724872CS♣  | 265 | 1,422.00   | BU-724872CA♣  | 242 | 1,275.00 | BU-7248C♣         | 73.0  | 376.00   |
| 96 48 72                     | 2,150                   | 4                           | BU-964872CS♣  | 331 | 1,764.00   | BU-964872CA♣  | 308 | 1,617.00 | BU-9648C♣         | 95.0  | 490.00   |
| 48 48 84                     | 1,500                   | 2                           | BU-484884CS♣  | 201 | 1,216.00   | BU-484884CA♣  | 174 | 1,007.00 | BU-4848C♣         | 49.0  | 266.00   |
| 72 48 84                     | 2,750                   | 3                           | BU-724884CS♣  | 246 | 1,546.00   | BU-724884CA♣  | 273 | 1,337.00 | BU-7248C♣         | 73.0  | 376.00   |
| 96 48 84                     | 2,150                   | 4                           | BU-964884CS♣  | 339 | 1,888.00   | BU-964884CA♣  | 312 | 1,670.00 | BU-9648C♣         | 95.0  | 490.00   |
| 48 48 96                     | 1,500                   | 2                           | BU-484896CS♣  | 213 | 1,198.00   | BU-484896CA♣  | 180 | 998.00   | BU-4848C♣         | 49.0  | 266.00   |
| 72 48 96                     | 2,750                   | 3                           | BU-724896CS♣  | 285 | 1,528.00   | BU-724896CA♣  | 252 | 1,328.00 | BU-7248C♣         | 73.0  | 376.00   |
| 96 48 96                     | 2,150                   | 4                           | BU-964896CS♣  | 351 | 1,870.00   | BU-964896CA♣  | 318 | 1,670.00 | BU-9648C♣         | 95.0  | 490.00   |
| 48 48 120                    | 1,500                   | 2                           | BU-4848120CS♣ | 223 | 1,266.00   | BU-4848120CA♣ | 185 | 1,032.00 | BU-4848C♣         | 49.0  | 266.00   |
| 72 48 120                    | 2,750                   | 3                           | BU-7248120CS♣ | 295 | 1,596.00   | BU-7248120CA♣ | 257 | 1,362.00 | BU-7248C♣         | 73.0  | 376.00   |
| 96 48 120                    | 2,150                   | 4                           | BU-9648120CS♣ | 361 | 1,938.00   | BU-9648120CA♣ | 323 | 1,704.00 | BU-9648C♣         | 95.0  | 490.00   |
| <b>Wire Decking**</b>        |                         |                             |               |     |            |               |     |          |                   |       |          |
| 48 48 72                     | 1,500                   | 2                           | BU-484872WS♣  | 172 | \$1,077.00 | BU-484872WA♣  | 149 | \$930.00 | BU-4848W♣         | 42.0  | \$261.00 |
| 72 48 72                     | 2,750                   | 3                           | BU-724872WS♣  | 235 | 1,323.00   | BU-724872WA♣  | 212 | 1,176.00 | BU-7248W♣         | 63.0  | 343.00   |
| 96 48 72                     | 2,150                   | 4                           | BU-964872WS♣  | 283 | 1,779.00   | BU-964872WA♣  | 260 | 1,632.00 | BU-9648W♣         | 79.0  | 495.00   |
| 48 48 84                     | 1,500                   | 2                           | BU-484884WS♣  | 180 | 1,172.00   | BU-484884WA♣  | 153 | 992.00   | BU-4848W♣         | 42.0  | 261.00   |
| 72 48 84                     | 2,750                   | 3                           | BU-724884WS♣  | 243 | 1,447.00   | BU-724884WA♣  | 216 | 1,238.00 | BU-7248W♣         | 63.0  | 343.00   |
| 96 48 84                     | 2,150                   | 4                           | BU-964884WS♣  | 291 | 1,903.00   | BU-964884WA♣  | 264 | 1,694.00 | BU-9648W♣         | 79.0  | 495.00   |
| 48 48 96                     | 1,500                   | 2                           | BU-484896WS♣  | 192 | 1,183.00   | BU-484896WA♣  | 159 | 984.00   | BU-4848W♣         | 42.0  | 261.00   |
| 72 48 96                     | 2,750                   | 3                           | BU-724896WS♣  | 255 | 1,429.00   | BU-724896WA♣  | 222 | 1,229.00 | BU-7248W♣         | 63.0  | 343.00   |
| 96 48 96                     | 2,150                   | 4                           | BU-964896WS♣  | 303 | 1,885.00   | BU-964896WA♣  | 270 | 1,685.00 | BU-9648W♣         | 79.0  | 495.00   |
| 48 48 120                    | 1,500                   | 2                           | BU-4848120WS♣ | 202 | 1,251.00   | BU-4848120WA♣ | 164 | 1,017.00 | BU-4848W♣         | 42.0  | 261.00   |
| 72 48 120                    | 2,750                   | 3                           | BU-7248120WS♣ | 265 | 1,497.00   | BU-7248120WA♣ | 227 | 1,265.00 | BU-7248W♣         | 63.0  | 343.00   |
| 96 48 120                    | 2,150                   | 4                           | BU-9648120WS♣ | 313 | 1,953.00   | BU-9648120WA♣ | 275 | 1,719.00 | BU-9648W♣         | 79.0  | 495.00   |

- Assembly required.

**Standard Colors (Unless Otherwise Specified)**



♣ Items with this symbol are available to ship in 2-3 days. Limited quantities and select colors. ♣ (MGY)

SHELVING

# Bulk Storage: Components

## BULK UPRIGHTS

| CAT. NO.         | W     | D  | H   | WT. | PRICE    |
|------------------|-------|----|-----|-----|----------|
| <b>72" High</b>  |       |    |     |     |          |
| BUF-2472♣        | 1 3/4 | 24 | 72  | 20  | \$123.00 |
| BUF-3672♣        | 1 3/4 | 36 | 72  | 22  | 133.00   |
| BUF-4272*        | 1 3/4 | 42 | 72  | 22  | 192.00   |
| BUF-4872♣        | 1 3/4 | 48 | 72  | 23  | 147.00   |
| <b>84" High</b>  |       |    |     |     |          |
| BUF-2484♣        | 1 3/4 | 24 | 84  | 24  | \$168.00 |
| BUF-3684♣        | 1 3/4 | 36 | 84  | 25  | 179.00   |
| BUF-4884♣        | 1 3/4 | 48 | 84  | 27  | 209.00   |
| <b>96" High</b>  |       |    |     |     |          |
| BUF-2496♣        | 1 3/4 | 24 | 96  | 28  | \$164.00 |
| BUF-3696♣        | 1 3/4 | 36 | 96  | 30  | 183.00   |
| BUF-4296*        | 1 3/4 | 42 | 96  | 32  | 225.00   |
| BUF-4896♣        | 1 3/4 | 48 | 96  | 33  | 200.00   |
| <b>120" High</b> |       |    |     |     |          |
| BUF-24120♣       | 1 3/4 | 24 | 120 | 33  | \$200.00 |
| BUF-36120♣       | 1 3/4 | 36 | 120 | 36  | 216.00   |
| BUF-42120*       | 1 3/4 | 42 | 120 | 37  | 305.00   |
| BUF-48120♣       | 1 3/4 | 48 | 120 | 38  | 234.00   |
| <b>144" High</b> |       |    |     |     |          |
| BUF-24144*       | 1 3/4 | 24 | 144 | 40  | \$305.00 |
| BUF-36144*       | 1 3/4 | 36 | 144 | 43  | 319.00   |
| BUF-48144*       | 1 3/4 | 48 | 144 | 46  | 319.00   |
| <b>168" High</b> |       |    |     |     |          |
| BUF-24168*       | 1 3/4 | 24 | 168 | 46  | \$379.00 |
| BUF-36168*       | 1 3/4 | 36 | 168 | 50  | 371.00   |
| BUF-48168*       | 1 3/4 | 48 | 168 | 53  | 402.00   |
| <b>192" High</b> |       |    |     |     |          |
| BUF-24192*       | 1 3/4 | 24 | 192 | 53  | \$385.00 |
| BUF-36192*       | 1 3/4 | 36 | 192 | 57  | 395.00   |
| BUF-48192*       | 1 3/4 | 48 | 192 | 64  | 414.00   |

\*Set-up charges will be applied, contact factory for pricing.  
Other sizes available, contact factory for pricing.

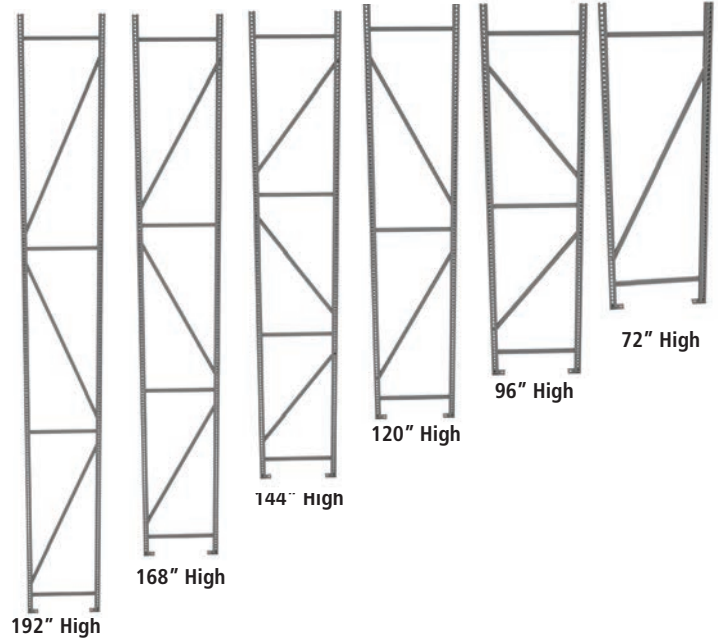

For uprights without feet, add "NFP" to the catalog number, i.e. BUF-2472NFP.  
17,000 lbs. capacity based on maximum vertical distance of 24" between any two beams on floor.

National Motor Freight Class: 70

## RACK SPACER

| CAT. NO. | W       | D | H       | WT. | PRICE   |
|----------|---------|---|---------|-----|---------|
| BRS-6    | 8 29/32 | 1 | 5 13/16 | 1.0 | \$13.90 |

Mounting hardware is included with part.

National Motor Freight Class: 70

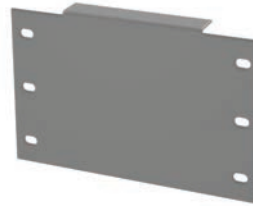

Used to attach back-to-back units.  
Maintains a 6" gap to meet fire codes.

## BULK UPRIGHT EXTENSION

| CAT. NO. | W       | D     | H       | WT. | PRICE   |
|----------|---------|-------|---------|-----|---------|
| SPBUF-10 | 8 29/32 | 1 1/2 | 5 13/16 | 3.3 | \$22.00 |

National Motor Freight Class: 70



Used to splice two bulk frames together for additional height.

Top upright must be ordered without welded feet.

## SAFETY PLUGS

| CAT. NO. | W | D | H | WT. | PRICE  |
|----------|---|---|---|-----|--------|
| BSP-4*   | — | — | — | 0.4 | \$2.70 |

\*Plastic plugs come in a pack of 4.

National Motor Freight Class: 70

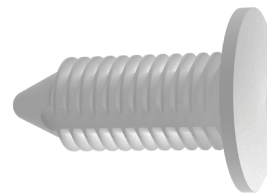

### Standard Colors (Unless Otherwise Specified)



♣  
Items with these symbols are available to ship in 2-3 days. Limited quantities and select colors.



## DECKING TYPES



Units are intended to be hand loaded only.

\*Wire decking uses 5 gauge wire and consists of a 2" x 4" mesh pattern. Price shown for wire decking is for Medium Grey. For price of Sand or Light Grey, add a 10% upcharge.

\*\*All corrugated decking comes in 12" wide sections

National Motor Freight Class: 70

| CAT. NO.                          | W  | D  | H    | WT.  | PRICE          |
|-----------------------------------|----|----|------|------|----------------|
| <b>Wire Decking*</b>              |    |    |      |      |                |
| ZWD-4824♣                         | 48 | 24 | 5/16 | 10.7 | <b>\$85.00</b> |
| ZWD-4836♣                         | 48 | 36 | 5/16 | 16.0 | <b>116.00</b>  |
| ZWD-4848♣                         | 48 | 48 | 5/16 | 21.0 | <b>149.00</b>  |
| ZWD-6024                          | 60 | 24 | 5/16 | 13.3 | <b>139.00</b>  |
| ZWD-6036♣                         | 60 | 36 | 5/16 | 20.0 | <b>153.00</b>  |
| ZWD-6048                          | 60 | 48 | 5/16 | 27.0 | <b>211.00</b>  |
| ZWD-7224♣                         | 72 | 24 | 5/16 | 16.0 | <b>131.00</b>  |
| ZWD-7236♣                         | 72 | 36 | 5/16 | 24.0 | <b>161.00</b>  |
| ZWD-7248♣                         | 72 | 48 | 5/16 | 32.0 | <b>190.00</b>  |
| ZWD-9624♣♣                        | 96 | 24 | 5/16 | 21.0 | <b>170.00</b>  |
| ZWD-9636♣♣                        | 96 | 36 | 5/16 | 32.0 | <b>232.00</b>  |
| ZWD-9648♣♣                        | 96 | 48 | 5/16 | 42.0 | <b>298.00</b>  |
| <b>Corrugated Steel Decking**</b> |    |    |      |      |                |
| BSD-4824♣                         | 48 | 24 | 9/16 | 14.0 | <b>\$85.00</b> |
| BSD-4836♣                         | 48 | 36 | 9/16 | 21.0 | <b>125.00</b>  |
| BSD-4848♣                         | 48 | 48 | 9/16 | 28.0 | <b>154.00</b>  |
| BSD-6024♣                         | 60 | 24 | 9/16 | 17.9 | <b>105.00</b>  |
| BSD-6036♣                         | 60 | 36 | 9/16 | 26.0 | <b>151.00</b>  |
| BSD-6048♣                         | 60 | 48 | 9/16 | 36.0 | <b>189.00</b>  |
| BSD-7224♣                         | 72 | 24 | 9/16 | 21.0 | <b>123.00</b>  |
| BSD-7236♣                         | 72 | 36 | 9/16 | 31.0 | <b>178.00</b>  |
| BSD-7248♣                         | 72 | 48 | 9/16 | 42.0 | <b>223.00</b>  |
| BSD-9624♣                         | 96 | 24 | 9/16 | 28.0 | <b>158.00</b>  |
| BSD-9636♣                         | 96 | 36 | 9/16 | 40.0 | <b>230.00</b>  |
| BSD-9648♣                         | 96 | 48 | 9/16 | 58.0 | <b>293.00</b>  |
| <b>Particleboard Decking</b>      |    |    |      |      |                |
| PB-4824□                          | 48 | 24 | 5/8  | 20.0 | <b>\$40.00</b> |
| PB-4836□                          | 48 | 36 | 5/8  | 31.0 | <b>59.00</b>   |
| PB-4848□                          | 48 | 48 | 5/8  | 40.0 | <b>81.00</b>   |
| PB-6024□                          | 60 | 24 | 5/8  | 25.0 | <b>50.00</b>   |
| PB-6036□                          | 60 | 36 | 5/8  | 37.5 | <b>79.00</b>   |
| PB-6048□                          | 60 | 48 | 5/8  | 50.0 | <b>95.00</b>   |
| PB-7224□                          | 72 | 24 | 5/8  | 30.0 | <b>65.00</b>   |
| PB-7236□                          | 72 | 36 | 5/8  | 45.0 | <b>90.00</b>   |
| PB-7248□                          | 72 | 48 | 5/8  | 60.0 | <b>119.00</b>  |
| PB-9624□                          | 96 | 24 | 5/8  | 40.0 | <b>81.00</b>   |
| PB-9636□                          | 96 | 36 | 5/8  | 60.0 | <b>119.00</b>  |
| PB-9648□                          | 96 | 48 | 5/8  | 80.0 | <b>158.00</b>  |

†Comes in two 48" wide sections.

## DECK LEVELS

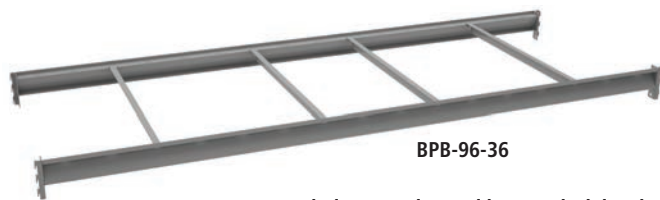

Includes two plywood beams, deck level reinforcements and safety plugs.

Additional Deck Level Reinforcements (BPS-dd) can be added for extra deck support and weight capacity.

National Motor Freight Class: 70

| CAT. NO.   | Reinforcements Included | Load Cap. | WT.  | PRICE          |
|------------|-------------------------|-----------|------|----------------|
| BPB-48-24♣ | 2                       | 4,150     | 18.1 | <b>\$98.00</b> |
| BPB-48-36♣ | 2                       | 3,000     | 18.5 | <b>105.00</b>  |
| BPB-48-48♣ | 2                       | 1,500     | 21.0 | <b>112.00</b>  |
| BPB-60-24♣ | 2                       | 3,800     | 21.0 | <b>111.00</b>  |
| BPB-60-36♣ | 2                       | 3,800     | 23.0 | <b>116.00</b>  |
| BPB-60-48♣ | 2                       | 3,800     | 23.0 | <b>125.00</b>  |
| BPB-72-24♣ | 3                       | 2,750     | 25.0 | <b>132.00</b>  |
| BPB-72-36♣ | 3                       | 2,750     | 27.0 | <b>139.00</b>  |
| BPB-72-48♣ | 3                       | 2,750     | 31.0 | <b>153.00</b>  |
| BPB-96-24♣ | 4                       | 2,150     | 34.0 | <b>168.00</b>  |
| BPB-96-36♣ | 4                       | 2,150     | 37.0 | <b>179.00</b>  |
| BPB-96-48♣ | 4                       | 2,150     | 37.0 | <b>197.00</b>  |

## DECK LEVEL REINFORCEMENTS



National Motor Freight Class: 70

| CAT. NO. | W | D  | H       | WT. | PRICE         |
|----------|---|----|---------|-----|---------------|
| BPS-24♣  | 1 | 24 | 1 15/16 | 1.3 | <b>\$8.10</b> |
| BPS-36♣  | 1 | 36 | 1 15/16 | 2.1 | <b>10.90</b>  |
| BPS-48♣  | 1 | 48 | 1 15/16 | 2.7 | <b>15.00</b>  |

### Standard Colors (Unless Otherwise Specified)



Items with these symbols are available to ship in 2-3 days. Limited quantities and select colors.





# Q-Line Industrial Clip Shelving

\*Load capacities are based on evenly distributed loads.

## OPEN STYLE SHELVING



**Starter Units Include:**

- 4 Offset Angle Posts
- 2 Sets of Side Sway Braces
- 1 Set of Back Sway Braces
- 5 Steel Shelves

National Motor  
Freight Class: 70

- Assembly required.

QOH5-3618S



**"AB" Adder Units Include:**

- 2 Offset Angle Posts
- 1 Beaded Post
- 1 Set of Side Sway Braces
- 1 Set of Back Sway Braces
- 5 Steel Shelves

National Motor  
Freight Class: 70

- Assembly required.

QOH5-3618AB



**"A" Adder Units Include:**

- 4 Offset Angle Posts
- 1 Set of Side Sway Braces
- 1 Set of Back Sway Braces
- 5 Steel Shelves

National Motor  
Freight Class: 70

- Assembly required.

QOH5-3618A

| UNIT SIZE                  |    |    | SHELF CAP.* | STARTER UNITS |     |          | ADDER UNITS |     |          | EXTRA SHELF |     |          |         |      |         |
|----------------------------|----|----|-------------|---------------|-----|----------|-------------|-----|----------|-------------|-----|----------|---------|------|---------|
| W                          | D  | H  |             | CAT. NO.      | WT. | PRICE    | CAT. NO.    | WT. | PRICE    | CAT. NO.    | WT. | PRICE    |         |      |         |
| <b>20 Gauge, 5 Shelves</b> |    |    |             |               |     |          |             |     |          |             |     |          |         |      |         |
| 36                         | 12 | 87 | 1,000       | QOH5-3612S    | 69  | \$387.00 | QOH5-3612AB | 62  | \$360.00 | QOH5-3612A  | 66  | \$376.00 | Q-3612  | 8.0  | \$49.00 |
| 48                         | 12 | 87 | 650         | QOH5-4812S    | 82  | 464.00   | QOH5-4812AB | 75  | 437.00   | QOH5-4812A  | 79  | 453.00   | Q-4812  | 10.4 | 64.00   |
| 36                         | 18 | 87 | 850         | QOH5-3618S    | 82  | 447.00   | QOH5-3618AB | 75  | 420.00   | QOH5-3618A  | 79  | 436.00   | Q-3618  | 10.5 | 61.00   |
| 48                         | 18 | 87 | 550         | QOH5-4818S    | 98  | 554.00   | QOH5-4818AB | 91  | 527.00   | QOH5-4818A  | 95  | 543.00   | Q-4818  | 13.6 | 82.00   |
| 36                         | 24 | 87 | 800         | QOH5-3624S    | 94  | 522.00   | QOH5-3624AB | 87  | 495.00   | QOH5-3624A  | 91  | 508.00   | Q-3624  | 13.0 | 76.00   |
| 48                         | 24 | 87 | 550         | QOH5-4824S    | 114 | 589.00   | QOH5-4824AB | 107 | 562.00   | QOH5-4824A  | 111 | 578.00   | Q-4824  | 16.8 | 89.00   |
| <b>22 Gauge, 5 Shelves</b> |    |    |             |               |     |          |             |     |          |             |     |          |         |      |         |
| 36                         | 12 | 87 | 750         | QO5-3612S     | 63  | \$347.00 | QO5-3612AB  | 56  | \$320.00 | QO5-3612A   | 60  | \$333.00 | Q2-3612 | 6.7  | \$41.00 |
| 48                         | 12 | 87 | 500         | QO5-4812S     | 73  | 389.00   | QO5-4812AB  | 66  | 362.00   | QO5-4812A   | 71  | 375.00   | Q2-4812 | 8.7  | 49.00   |
| 36                         | 18 | 87 | 750         | QO5-3618S     | 73  | 397.00   | QO5-3618AB  | 66  | 370.00   | QO5-3618A   | 71  | 383.00   | Q2-3618 | 8.8  | 51.00   |
| 48                         | 18 | 87 | 500         | QO5-4818S     | 87  | 464.00   | QO5-4818AB  | 80  | 437.00   | QO5-4818A   | 84  | 450.00   | Q2-4818 | 11.4 | 64.00   |
| 36                         | 24 | 87 | 700         | QO5-3624S     | 84  | 447.00   | QO5-3624AB  | 77  | 420.00   | QO5-3624A   | 81  | 433.00   | Q2-3624 | 10.9 | 61.00   |
| 48                         | 24 | 87 | 450         | QO5-4824S     | 100 | 519.00   | QO5-4824AB  | 93  | 492.00   | QO5-4824A   | 98  | 505.00   | Q2-4824 | 14.1 | 75.00   |

\*Load capacities are based on evenly distributed loads.

## CLOSED STYLE SHELVING



**Starter Units Include:**

- 4 Offset Angle Posts
- 2 Side Panels
- 1 Back Panel
- 5 Steel Shelves

National Motor  
Freight Class: 70

- Assembly required.

QCH5-3618S



**"AB" Adder Units Include:**

- 2 Offset Angle Posts
- 1 Beaded Post
- 1 Side Panel
- 1 Back Panel
- 5 Steel Shelves

National Motor  
Freight Class: 70

- Assembly required.

QCH5-3618AB



**"A" Adder Units Include:**

- 4 Offset Angle Posts
- 1 Side Panel
- 1 Back Panel
- 5 Steel Shelves

National Motor  
Freight Class: 70

- Assembly required.

QCH5-3618A

| UNIT SIZE                  |    |    | SHELF CAP.* | STARTER UNITS |     |          | ADDER UNITS |     |          | EXTRA SHELF |     |          |         |      |         |
|----------------------------|----|----|-------------|---------------|-----|----------|-------------|-----|----------|-------------|-----|----------|---------|------|---------|
| W                          | D  | H  |             | CAT. NO.      | WT. | PRICE    | CAT. NO.    | WT. | PRICE    | CAT. NO.    | WT. | PRICE    |         |      |         |
| <b>20 Gauge, 5 Shelves</b> |    |    |             |               |     |          |             |     |          |             |     |          |         |      |         |
| 36                         | 12 | 87 | 1,000       | QCH5-3612S    | 95  | \$573.00 | QCH5-3612AB | 85  | \$518.00 | QCH5-3612A  | 90  | \$531.00 | Q-3612  | 8.0  | \$49.00 |
| 48                         | 12 | 87 | 650         | QCH5-4812S    | 116 | 691.00   | QCH5-4812AB | 106 | 636.00   | QCH5-4812A  | 111 | 649.00   | Q-4812  | 10.4 | 64.00   |
| 36                         | 18 | 87 | 850         | QCH5-3618S    | 116 | 675.00   | QCH5-3618AB | 101 | 599.00   | QCH5-3618A  | 111 | 612.00   | Q-3618  | 10.5 | 61.00   |
| 48                         | 18 | 87 | 550         | QCH5-4818S    | 140 | 823.00   | QCH5-4818AB | 126 | 747.00   | QCH5-4818A  | 132 | 760.00   | Q-4818  | 13.6 | 82.00   |
| 36                         | 24 | 87 | 800         | QCH5-3624S    | 135 | 788.00   | QCH5-3624AB | 117 | 693.00   | QCH5-3624A  | 123 | 706.00   | Q-3624  | 13.0 | 76.00   |
| 48                         | 24 | 87 | 550         | QCH5-4824S    | 163 | 896.00   | QCH5-4824AB | 145 | 801.00   | QCH5-4824A  | 152 | 814.00   | Q-4824  | 16.8 | 89.00   |
| <b>22 Gauge, 5 Shelves</b> |    |    |             |               |     |          |             |     |          |             |     |          |         |      |         |
| 36                         | 12 | 87 | 750         | QC5-3612S     | 89  | \$533.00 | QC5-3612AB  | 78  | \$478.00 | QC5-3612A   | 83  | \$491.00 | Q2-3612 | 6.7  | \$41.00 |
| 48                         | 12 | 87 | 500         | QC5-4812S     | 108 | 616.00   | QC5-4812AB  | 97  | 561.00   | QC5-4812A   | 102 | 574.00   | Q2-4812 | 8.7  | 49.00   |
| 36                         | 18 | 87 | 750         | QC5-3618S     | 107 | 625.00   | QC5-3618AB  | 93  | 549.00   | QC5-3618A   | 97  | 562.00   | Q2-3618 | 8.8  | 51.00   |
| 48                         | 18 | 87 | 500         | QC5-4818S     | 129 | 733.00   | QC5-4818AB  | 115 | 657.00   | QC5-4818A   | 119 | 670.00   | Q2-4818 | 11.4 | 64.00   |
| 36                         | 24 | 87 | 700         | QC5-3624S     | 125 | 713.00   | QC5-3624AB  | 107 | 618.00   | QC5-3624A   | 111 | 631.00   | Q2-3624 | 10.9 | 61.00   |
| 48                         | 24 | 87 | 450         | QC5-4824S     | 150 | 826.00   | QC5-4824AB  | 132 | 731.00   | QC5-4824A   | 136 | 744.00   | Q2-4824 | 14.1 | 75.00   |

**Standard Colors**



Items with this symbol are available to ship in 2-3 days. Limited quantities and select colors. (MGY)

# Q-Line Shelving: Components

## UPRIGHT POSTS



OFFSET  
ANGLE POST



INTERMEDIATE  
BEADED POST



HEAVY-DUTY  
INTERMEDIATE  
BEADED POST

Post slotted for shelf adjustment on 1" centers. Total weight capacity not to exceed 5,000 lbs. per unit for OAP and HBP posts. Weight capacity not to exceed 3,500 lbs per unit for BTP posts. Capacities based upon 24" shelf centers or less.

National Motor Freight Class: 70

| CAT. NO.                        | W   | D     | H   | WT.  | PRICE   |
|---------------------------------|-----|-------|-----|------|---------|
| <b>Offset Angle Post</b>        |     |       |     |      |         |
| OAP-39                          | 1   | 1 7/8 | 39  | 2.4  | \$11.00 |
| OAP-48                          | 1   | 1 7/8 | 48  | 2.9  | 13.30   |
| OAP-51                          | 1   | 1 7/8 | 51  | 3.1  | 14.40   |
| OAP-75♣                         | 1   | 1 7/8 | 75  | 4.6  | 20.00   |
| OAP-84♣                         | 1   | 1 7/8 | 84  | 5.1  | 23.00   |
| OAP-87♣                         | 1   | 1 7/8 | 87  | 5.3  | 24.00   |
| OAP-96                          | 1   | 1 7/8 | 96  | 5.9  | 27.00   |
| OAP-99                          | 1   | 1 7/8 | 99  | 6.0  | 29.00   |
| OAP-108                         | 1   | 1 7/8 | 108 | 6.8  | 31.00   |
| OAP-111                         | 1   | 1 7/8 | 111 | 6.8  | 31.00   |
| OAP-123                         | 1   | 1 7/8 | 123 | 7.5  | 35.00   |
| <b>Beaded T-Post</b>            |     |       |     |      |         |
| BTP-39*                         | 3/8 | 1 7/8 | 39  | 2.7  | \$24.00 |
| BTP-48*                         | 3/8 | 1 7/8 | 48  | 3.4  | 29.00   |
| BTP-51*                         | 3/8 | 1 7/8 | 51  | 3.6  | 30.00   |
| BTP-75♣                         | 3/8 | 1 7/8 | 75  | 5.3  | 31.00   |
| BTP-84♣                         | 3/8 | 1 7/8 | 84  | 5.9  | 35.00   |
| BTP-87♣                         | 3/8 | 1 7/8 | 87  | 6.1  | 35.00   |
| <b>Heavy Duty Beaded T-Post</b> |     |       |     |      |         |
| HBP-39*                         | 3/4 | 2 7/8 | 39  | 4.4  | \$54.00 |
| HBP-48*                         | 3/4 | 2 7/8 | 48  | 5.4  | 57.00   |
| HBP-51*                         | 3/4 | 2 7/8 | 51  | 5.7  | 68.00   |
| HBP-75*                         | 3/4 | 2 7/8 | 75  | 8.4  | 80.00   |
| HBP-84*                         | 3/4 | 2 7/8 | 84  | 9.4  | 85.00   |
| HBP-87♣                         | 3/4 | 2 7/8 | 87  | 9.8  | 85.00   |
| HBP-99*                         | 3/4 | 2 7/8 | 99  | 11.1 | 90.00   |
| HBP-111*                        | 3/4 | 2 7/8 | 111 | 12.5 | 75.00   |
| HBP-123*                        | 3/4 | 2 7/8 | 123 | 13.9 | 87.00   |

\*Set-up charges will be applied, contact factory for pricing.

## WELDED UPRIGHTS



These are panels welded to OAP style posts. Set-up charges will be applied, contact factory for pricing on intermediate welded uprights.

| DEPTH    | CAT. NO. | H  | WT.  | PRICE   |
|----------|----------|----|------|---------|
| 12" DEEP | WU-1239  | 39 | 7.1  | \$68.00 |
|          | WU-1251  | 51 | 9.3  | 80.00   |
|          | WU-1275  | 75 | 13.7 | 95.00   |
|          | WU-1284  | 84 | 15.3 | 102.00  |
|          | WU-1287  | 87 | 15.8 | 107.00  |
| 15" DEEP | WU-1539  | 39 | 8.0  | 68.00   |
|          | WU-1551  | 51 | 10.5 | 80.00   |
|          | WU-1575  | 75 | 15.5 | 102.00  |
|          | WU-1584  | 84 | 17.3 | 113.00  |
| 18" DEEP | WU-1587  | 87 | 17.9 | 114.00  |
|          | WU-1839  | 39 | 9.1  | 75.00   |
|          | WU-1851  | 51 | 11.9 | 92.00   |
| 24" DEEP | WU-1875  | 75 | 17.3 | 107.00  |
|          | WU-1884  | 84 | 19.6 | 128.00  |
|          | WU-1887  | 87 | 20.3 | 124.00  |
|          | WU-2439  | 39 | 10.3 | 83.00   |
| 30" DEEP | WU-2451  | 51 | 13.4 | 102.00  |
|          | WU-2475  | 75 | 19.7 | 131.00  |
|          | WU-2484  | 84 | 22.1 | 151.00  |
|          | WU-2487  | 87 | 22.9 | 150.00  |
| 36" DEEP | WU-3039  | 39 | 11.5 | 90.00   |
|          | WU-3051  | 51 | 15.1 | 110.00  |
|          | WU-3075  | 75 | 22.1 | 159.00  |
|          | WU-3084  | 84 | 24.8 | 173.00  |
| 36" DEEP | WU-3087  | 87 | 25.7 | 177.00  |
|          | WU-3639  | 39 | 13.0 | 101.00  |
|          | WU-3651  | 51 | 17.0 | 121.00  |
|          | WU-3675  | 75 | 25.0 | 175.00  |
| 36" DEEP | WU-3684  | 84 | 28.0 | 190.00  |
|          | WU-3687  | 87 | 29.0 | 197.00  |

National Motor Freight Class: 70

### Standard Colors



Items with this symbol are available to ship in 2-3 days. Limited quantities and select colors.



(MGY)

# Q-Line Shelving: Components

## BACK PANELS







| CAT. NO.         | H  | WT.  | PRICE           |
|------------------|----|------|-----------------|
| <b>36" Wide</b>  |    |      |                 |
| BP-3639          | 39 | 9.8  | <b>\$75.00</b>  |
| BP-3648          | 48 | 12.1 | <b>88.00</b>    |
| BP-3651          | 51 | 12.9 | <b>94.00</b>    |
| BP-3675♣         | 75 | 18.9 | <b>129.00</b>   |
| BP-3684♣         | 84 | 21.0 | <b>140.00</b>   |
| BP-3687♣         | 87 | 22.0 | <b>147.00</b>   |
| <b>42" Wide*</b> |    |      |                 |
| BP-4239          | 39 | 11.8 | <b>\$95.00</b>  |
| BP-4248          | 48 | 14.5 | <b>109.00</b>   |
| BP-4251          | 51 | 15.4 | <b>117.00</b>   |
| BP-4275          | 75 | 23.0 | <b>155.00</b>   |
| BP-4284          | 84 | 25.0 | <b>170.00</b>   |
| BP-4287          | 87 | 26.0 | <b>171.00</b>   |
| <b>48" Wide*</b> |    |      |                 |
| BP-4839          | 39 | 14.0 | <b>\$106.00</b> |
| BP-4848          | 48 | 17.0 | <b>120.00</b>   |
| BP-4851          | 51 | 18.1 | <b>128.00</b>   |
| BP-4875          | 75 | 27.0 | <b>171.00</b>   |
| BP-4884          | 84 | 30.0 | <b>188.00</b>   |
| BP-4887♣         | 87 | 31.0 | <b>190.00</b>   |

\*NOTE: 42" & 48" backs consist of two pieces.

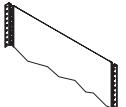

National Motor Freight Class: 70

## END PANELS

| DEPTH   | CAT. NO. | H  | WT.  | PRICE          |
|---|----------|----|------|----------------|
| 12" DEEP<br>  | EP-1239  | 39 | 2.7  | <b>\$30.00</b> |
|   | EP-1248  | 48 | 3.3  | <b>32.00</b>   |
|   | EP-1251  | 51 | 3.5  | <b>33.00</b>   |
|   | EP-1275  | 75 | 5.1  | <b>42.00</b>   |
|   | EP-1284  | 84 | 5.7  | <b>45.00</b>   |
|   | EP-1287♣ | 87 | 6.0  | <b>42.00</b>   |
| 15" DEEP<br> | EP-1539  | 39 | 3.7  | <b>34.00</b>   |
|   | EP-1548  | 48 | 4.5  | <b>38.00</b>   |
|   | EP-1551  | 51 | 4.8  | <b>39.00</b>   |
|   | EP-1575  | 75 | 7.1  | <b>52.00</b>   |
|   | EP-1584  | 84 | 7.9  | <b>56.00</b>   |
|   | EP-1587  | 87 | 8.2  | <b>56.00</b>   |
| 18" DEEP<br> | EP-1839  | 39 | 4.5  | <b>38.00</b>   |
|   | EP-1848  | 48 | 5.5  | <b>41.00</b>   |
|   | EP-1851  | 51 | 5.9  | <b>45.00</b>   |
|   | EP-1875♣ | 75 | 8.6  | <b>60.00</b>   |
|   | EP-1884♣ | 84 | 9.6  | <b>61.00</b>   |
|   | EP-1887♣ | 87 | 10.0 | <b>63.00</b>   |
| 24" DEEP<br> | EP-2439  | 39 | 6.8  | <b>46.00</b>   |
|   | EP-2448  | 48 | 7.5  | <b>53.00</b>   |
|   | EP-2451  | 51 | 8.0  | <b>54.00</b>   |
|   | EP-2475  | 75 | 11.7 | <b>75.00</b>   |
|   | EP-2484  | 84 | 13.1 | <b>80.00</b>   |
|   | EP-2487♣ | 87 | 13.6 | <b>82.00</b>   |
| 30" DEEP<br> | EP-3039  | 39 | 7.9  | <b>53.00</b>   |
|   | EP-3048  | 48 | 9.7  | <b>65.00</b>   |
|   | EP-3051  | 51 | 10.3 | <b>69.00</b>   |
|   | EP-3075  | 75 | 15.2 | <b>94.00</b>   |
|   | EP-3084  | 84 | 17.0 | <b>102.00</b>  |
|   | EP-3087  | 87 | 17.6 | <b>105.00</b>  |
| 36" DEEP<br> | EP-3639  | 39 | 9.8  | <b>67.00</b>   |
|   | EP-3648  | 48 | 12.1 | <b>75.00</b>   |
|   | EP-3651  | 51 | 12.9 | <b>83.00</b>   |
|   | EP-3675  | 75 | 18.9 | <b>114.00</b>  |
|   | EP-3684  | 84 | 21.0 | <b>124.00</b>  |
|   | EP-3687  | 87 | 22.0 | <b>126.00</b>  |

National Motor Freight Class: 70



### Standard Colors



♣  
Items with these symbols are available to ship in 2-3 days. Limited quantities and select colors.



# Q-Line Shelving: Components

## SHELVES

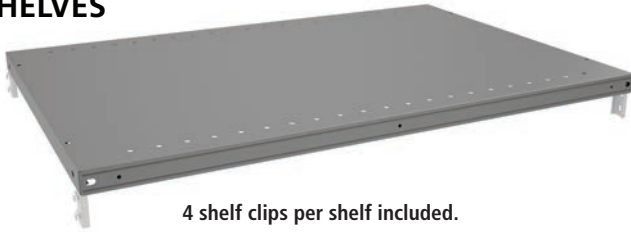

4 shelf clips per shelf included.



Shelves have a welded box formed construction with lapped and welded corners.

| CAT. NO.                          | Load Cap. | W  | D  | H      | WT.  | PRICE           |
|-----------------------------------|-----------|----|----|--------|------|-----------------|
| <b>20 Gauge With Stiffeners**</b> |           |    |    |        |      |                 |
| Q-3624-S*                         | 1,000     | 36 | 24 | 1 5/16 | 15.4 | <b>\$106.00</b> |
| Q-3630-S*                         | 1,000     | 36 | 30 | 1 5/16 | 18.1 | <b>\$129.00</b> |
| Q-3636-S*                         | 750       | 36 | 36 | 1 5/16 | 21.0 | <b>\$129.00</b> |
| Q-4224-S*                         | 800       | 42 | 24 | 1 5/16 | 17.6 | <b>\$117.00</b> |
| Q-4230-S*                         | 750       | 42 | 30 | 1 5/16 | 21.0 | <b>\$118.00</b> |
| Q-4236-S*                         | 700       | 42 | 36 | 1 5/16 | 24.0 | <b>\$132.00</b> |
| Q-4824-S*                         | 700       | 48 | 24 | 1 5/16 | 19.8 | <b>\$129.00</b> |
| Q-4830-S*                         | 650       | 48 | 30 | 1 5/16 | 23.0 | <b>\$159.00</b> |
| Q-4836-S*                         | 600       | 48 | 36 | 1 5/16 | 27.0 | <b>\$181.00</b> |

\*Set-up charges will be applied, contact factory for pricing.  
\*\*Bin dividers cannot be used on shelves with stiffeners.

National Motor Freight Class: 70

| CAT. NO.        | Load Cap. | W  | D  | H      | WT.  | PRICE           |
|-----------------|-----------|----|----|--------|------|-----------------|
| <b>22 Gauge</b> |           |    |    |        |      |                 |
| Q2-3612♣        | 750       | 36 | 12 | 1 5/16 | 6.7  | <b>\$41.00</b>  |
| Q2-3615♣        | 750       | 36 | 15 | 1 5/16 | 7.8  | <b>\$49.00</b>  |
| Q2-3618♣        | 750       | 36 | 18 | 1 5/16 | 8.8  | <b>\$51.00</b>  |
| Q2-3624♣        | 700       | 36 | 24 | 1 5/16 | 10.9 | <b>\$61.00</b>  |
| Q2-3630*♣       | 600       | 36 | 30 | 1 5/16 | 12.9 | <b>\$78.00</b>  |
| Q2-4212♣        | 600       | 42 | 12 | 1 5/16 | 7.7  | <b>\$51.00</b>  |
| Q2-4215♣        | 600       | 42 | 15 | 1 5/16 | 8.9  | <b>\$57.00</b>  |
| Q2-4218♣        | 600       | 42 | 18 | 1 5/16 | 10.1 | <b>\$59.00</b>  |
| Q2-4224♣        | 550       | 42 | 24 | 1 5/16 | 12.5 | <b>\$71.00</b>  |
| Q2-4230*♣       | 500       | 42 | 30 | 1 5/16 | 14.8 | <b>\$86.00</b>  |
| Q2-4812♣        | 500       | 48 | 12 | 1 5/16 | 8.7  | <b>\$49.00</b>  |
| Q2-4815♣        | 500       | 48 | 15 | 1 5/16 | 10.1 | <b>\$63.00</b>  |
| Q2-4818♣        | 500       | 48 | 18 | 1 5/16 | 11.4 | <b>\$64.00</b>  |
| Q2-4824♣        | 450       | 48 | 24 | 1 5/16 | 14.1 | <b>\$75.00</b>  |
| Q2-4830*♣       | 400       | 48 | 30 | 1 5/16 | 16.7 | <b>\$102.00</b> |
| <b>20 Gauge</b> |           |    |    |        |      |                 |
| Q-3612♣         | 1,000     | 36 | 12 | 1 5/16 | 8.0  | <b>\$49.00</b>  |
| Q-3615*         | 900       | 36 | 15 | 1 5/16 | 9.3  | <b>\$55.00</b>  |
| Q-3618♣         | 850       | 36 | 18 | 1 5/16 | 10.5 | <b>\$61.00</b>  |
| Q-3624♣         | 800       | 36 | 24 | 1 5/16 | 13.0 | <b>\$76.00</b>  |
| Q-3630*         | 800       | 36 | 30 | 1 5/16 | 15.4 | <b>\$98.00</b>  |
| Q-3636*         | 600       | 36 | 36 | 1 5/16 | 17.9 | <b>\$116.00</b> |
| Q-4212*         | 800       | 42 | 12 | 1 5/16 | 9.2  | <b>\$57.00</b>  |
| Q-4215*         | 700       | 42 | 15 | 1 5/16 | 10.6 | <b>\$64.00</b>  |
| Q-4218          | 650       | 42 | 18 | 1 5/16 | 12.0 | <b>\$71.00</b>  |
| Q-4224          | 650       | 42 | 24 | 1 5/16 | 14.9 | <b>\$83.00</b>  |
| Q-4230*         | 600       | 42 | 30 | 1 5/16 | 17.7 | <b>\$109.00</b> |
| Q-4236*         | 550       | 42 | 36 | 1 5/16 | 20.5 | <b>\$127.00</b> |
| Q-4812♣         | 650       | 48 | 12 | 1 5/16 | 10.4 | <b>\$64.00</b>  |
| Q-4815*         | 600       | 48 | 15 | 1 5/16 | 12.0 | <b>\$76.00</b>  |
| Q-4818♣         | 550       | 48 | 18 | 1 5/16 | 13.6 | <b>\$82.00</b>  |
| Q-4824♣         | 550       | 48 | 24 | 1 5/16 | 16.8 | <b>\$89.00</b>  |
| Q-4830*         | 500       | 48 | 30 | 1 5/16 | 19.9 | <b>\$123.00</b> |
| Q-4836*         | 450       | 48 | 36 | 1 5/16 | 23.0 | <b>\$140.00</b> |

## PERFORATED SHELVES



4 shelf clips per shelf included.

National Motor Freight Class: 70

| CAT. NO.  | Load Cap. | W  | D  | H      | WT.  | PRICE           |
|-----------|-----------|----|----|--------|------|-----------------|
| PQ2-3612P | 450       | 36 | 12 | 1 5/16 | 5.8  | <b>\$45.00</b>  |
| PQ2-3615P | 450       | 36 | 15 | 1 5/16 | 6.7  | <b>\$63.00</b>  |
| PQ2-3618P | 450       | 36 | 18 | 1 5/16 | 7.5  | <b>\$64.00</b>  |
| PQ2-3624P | 450       | 36 | 24 | 1 5/16 | 9.2  | <b>\$71.00</b>  |
| PQ2-3630P | 450       | 36 | 30 | 1 5/16 | 9.4  | <b>\$78.00</b>  |
| PQ2-4215P | 375       | 42 | 15 | 1 5/16 | 7.6  | <b>\$56.00</b>  |
| PQ2-4224P | 325       | 42 | 24 | 1 5/16 | 10.5 | <b>\$72.00</b>  |
| PQ2-4230P | 275       | 42 | 30 | 1 5/16 | 12.9 | <b>\$95.00</b>  |
| PQ2-4812P | 300       | 48 | 12 | 1 5/16 | 7.4  | <b>\$55.00</b>  |
| PQ2-4815P | 300       | 48 | 15 | 1 5/16 | 8.5  | <b>\$61.00</b>  |
| PQ2-4818P | 300       | 48 | 18 | 1 5/16 | 9.6  | <b>\$70.00</b>  |
| PQ2-4824P | 250       | 48 | 24 | 1 5/16 | 11.7 | <b>\$85.00</b>  |
| PQ2-4830P | 200       | 48 | 30 | 1 5/16 | 13.9 | <b>\$95.00</b>  |
| PQ2-4836P | 175       | 48 | 36 | 1 5/16 | 16.2 | <b>\$123.00</b> |

## SHELF LABEL HOLDERS



Attachment plugs included.

National Motor Freight Class: 70

| CAT. NO. | W  | D    | H   | WT. | PRICE         |
|----------|----|------|-----|-----|---------------|
| LH-36♣   | 36 | 3/16 | 7/8 | 0.3 | <b>\$4.60</b> |
| LH-42    | 42 | 3/16 | 7/8 | 0.4 | <b>4.80</b>   |
| LH-48♣   | 48 | 3/16 | 7/8 | 0.5 | <b>5.30</b>   |

## REPLACEMENT SHELF CLIPS

Attaches shelves to uprights. Shelf clips are Zinc Plated.

National Motor Freight Class: 70



| CAT. NO. | W | D   | H     | WT. | PRICE         |
|----------|---|-----|-------|-----|---------------|
| T-1      | 1 | 1/2 | 2 3/4 | 0.1 | <b>\$0.78</b> |

### Standard Colors (Unless Otherwise Specified)



♣ Items with these symbols are available to ship in 2-3 days. Limited quantities and select colors.



# Q-Line Shelving: Components

## BIN DIVIDERS

| CAT. NO.        | W    | D  | H  | WT. | PRICE          |
|-----------------|------|----|----|-----|----------------|
| <b>12" Deep</b> |      |    |    |     |                |
| BD-1206         | 7/32 | 12 | 6  | 0.6 | <b>\$11.50</b> |
| BD-1209         | 7/32 | 12 | 9  | 1.0 | <b>13.40</b>   |
| BD-1212         | 7/32 | 12 | 12 | 1.3 | <b>15.90</b>   |
| BD-1215*        | 7/32 | 12 | 15 | 1.6 | <b>17.70</b>   |
| BD-1218         | 7/32 | 12 | 18 | 1.9 | <b>19.00</b>   |
| <b>15" Deep</b> |      |    |    |     |                |
| BD-1506*        | 7/32 | 15 | 6  | 1.0 | <b>\$14.40</b> |
| BD-1509*        | 7/32 | 15 | 9  | 1.3 | <b>16.50</b>   |
| BD-1512*        | 7/32 | 15 | 12 | 1.8 | <b>20.00</b>   |
| BD-1515*        | 7/32 | 15 | 15 | 2.0 | <b>22.00</b>   |
| BD-1518*        | 7/32 | 15 | 18 | 2.7 | <b>24.00</b>   |
| <b>18" Deep</b> |      |    |    |     |                |
| BD-1806         | 7/32 | 18 | 6  | 1.2 | <b>\$14.40</b> |
| BD-1809         | 7/32 | 18 | 9  | 1.5 | <b>16.50</b>   |
| BD-1812♣        | 7/32 | 18 | 12 | 2.0 | <b>20.00</b>   |
| BD-1815         | 7/32 | 18 | 15 | 2.5 | <b>22.00</b>   |
| BD-1818         | 7/32 | 18 | 18 | 3.0 | <b>24.00</b>   |

National Motor Freight Class: 70



\*Set-up charges will be applied, contact factory for pricing.

## BIN FRONTS

| CAT. NO. | W  | D    | H | WT. | PRICE          |
|----------|----|------|---|-----|----------------|
| BF-362♣  | 36 | 3/64 | 2 | 1.3 | <b>\$14.30</b> |
| BF-422♣  | 42 | 3/64 | 2 | 1.5 | <b>16.90</b>   |
| BF-482♣  | 48 | 3/64 | 2 | 1.7 | <b>17.50</b>   |

National Motor Freight Class: 70

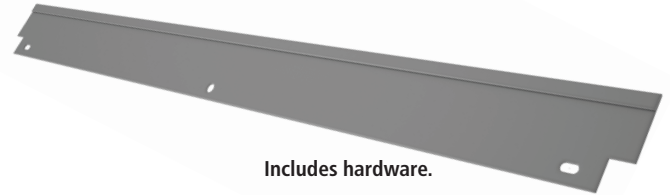

Includes hardware.

## END SWAY PLATES

| CAT. NO. | W | D      | H | WT. | PRICE          |
|----------|---|--------|---|-----|----------------|
| ESP-12   | — | 12 5/8 | 5 | 1.2 | <b>\$12.00</b> |
| ESP-18   | — | 18 5/8 | 5 | 2.0 | <b>15.40</b>   |
| ESP-24   | — | 24 5/8 | 5 | 2.8 | <b>18.60</b>   |

National Motor Freight Class: 70  
Available in Medium Grey only.

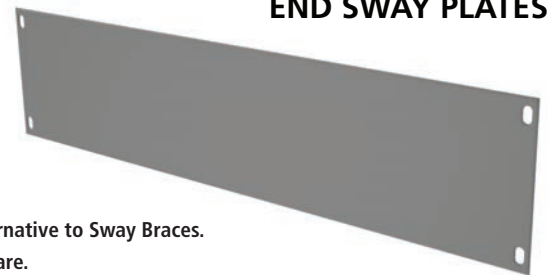

Used as an alternative to Sway Braces.  
Includes hardware.

## FOOT PLATE

| CAT. NO. | W     | D    | H     | WT. | PRICE         |
|----------|-------|------|-------|-----|---------------|
| FP-1     | 1 1/2 | 1/16 | 2 1/4 | 0.1 | <b>\$1.30</b> |

National Motor Freight Class: 70

Used to secure uprights to the floor.  
For units 120" and under in height.



## SEISMIC FOOT PLATE

| CAT. NO. | W     | D     | H     | WT. | PRICE         |
|----------|-------|-------|-------|-----|---------------|
| IFP-1    | 3 1/4 | 1 5/8 | 2 1/2 | 0.4 | <b>\$6.30</b> |

For units over 120" in height.  
Order one foot plate for each OAP upright and two foot plates back-to-back for each HBP upright, as shown.  
When seismic foot is used, bottom shelf is 6 9/32" above floor.  
National Motor Freight Class: 70



Single Foot Plate for OAP

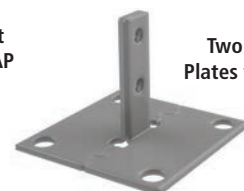

Two Foot Plates for HBP

### Standard Colors



♣ Items with these symbols are available to ship in 2-3 days. Limited quantities and select colors.



# Q-Line Shelving: Components

## SLIDING DIVIDERS



| CAT. NO.        | H     | WT. | PRICE          |
|-----------------|-------|-----|----------------|
| <b>12" Deep</b> |       |     |                |
| SD-1230         | 3     | 0.7 | <b>\$13.50</b> |
| SD-1245         | 4 1/2 | 0.9 | <b>14.70</b>   |
| SD-1260         | 6     | 1.0 | <b>15.60</b>   |
| <b>18" Deep</b> |       |     |                |
| SD-1830         | 3     | 1.1 | <b>\$16.50</b> |
| SD-1845         | 4 1/2 | 1.4 | <b>18.00</b>   |
| SD-1860         | 6     | 1.6 | <b>19.60</b>   |
| <b>24" Deep</b> |       |     |                |
| SD-2430         | 3     | 1.5 | <b>\$18.10</b> |
| SD-2445         | 4 1/2 | 1.8 | <b>20.00</b>   |
| SD-2460         | 6     | 2.0 | <b>22.00</b>   |

National Motor Freight Class: 70

## FRONT BASE STRIPS



| CAT. NO.  | W  | D   | H     | WT. | PRICE          |
|-----------|----|-----|-------|-----|----------------|
| FBS-362 ♣ | 36 | 1/2 | 1 7/8 | 1.2 | <b>\$16.50</b> |
| FBS-422   | 42 | 1/2 | 1 7/8 | 1.5 | <b>22.00</b>   |
| FBS-482 ♣ | 48 | 1/2 | 1 7/8 | 1.7 | <b>20.00</b>   |

National Motor Freight Class: 70

## MEZZANINE BRACKETS



MB-3



BMB-3

Includes hardware.

| CAT. NO.                          | W      | D       | H | WT. | PRICE         |
|-----------------------------------|--------|---------|---|-----|---------------|
| <b>For Offset Angle Post</b>      |        |         |   |     |               |
| MB-3                              | 1 1/16 | 2 1/4   | 3 | 0.5 | <b>\$6.30</b> |
| <b>For Heavy Duty Beaded Post</b> |        |         |   |     |               |
| BMB-3                             | 15/32  | 3 13/16 | 3 | 0.5 | <b>\$7.60</b> |

National Motor Freight Class: 70

## SPLICE PLATES

Includes hardware.



SPOA-4



SPBT-5

| CAT. NO.                          | W     | D      | H | WT. | PRICE          |
|-----------------------------------|-------|--------|---|-----|----------------|
| <b>For Offset Angle Post</b>      |       |        |   |     |                |
| SPOA-4                            | 27/32 | 1 1/8  | 4 | 0.3 | <b>\$6.50</b>  |
| <b>For Heavy Duty Beaded Post</b> |       |        |   |     |                |
| SPBT-5                            | 5/8   | 2 7/16 | 5 | 0.5 | <b>\$16.50</b> |

National Motor Freight Class: 70

## SHELF BOXES



\*Dividers are galvanized, not painted.

Available in Medium Grey only.

| CAT. NO.                   | W      | D    | H      | WT. | PRICE          |
|----------------------------|--------|------|--------|-----|----------------|
| <b>Shelf Boxes</b>         |        |      |        |     |                |
| BX-512                     | 5 5/8  | 11   | 4 9/16 | 2.5 | <b>\$26.00</b> |
| BX-518                     | 5 5/8  | 17   | 4 9/16 | 3.3 | <b>30.00</b>   |
| BX-812                     | 8 3/8  | 11   | 4 9/16 | 3.5 | <b>30.00</b>   |
| BX-818                     | 8 3/8  | 17   | 4 9/16 | 4.3 | <b>38.00</b>   |
| BX-1112                    | 11 1/4 | 11   | 4 9/16 | 4.5 | <b>41.00</b>   |
| BX-1118                    | 11 1/4 | 17   | 4 9/16 | 5.3 | <b>45.00</b>   |
| <b>Shelf Box Dividers*</b> |        |      |        |     |                |
| BXD-5                      | 5 3/16 | 1/32 | 4 1/2  | 0.2 | <b>\$1.60</b>  |
| BXD-8                      | 8      | 1/32 | 4 1/2  | 0.3 | <b>2.00</b>    |
| BXD-11                     | 10 7/8 | 1/32 | 4 1/2  | 0.4 | <b>3.10</b>    |

National Motor Freight Class: 70

### Standard Colors (Unless Otherwise Specified)



Sand (SND) Light Grey (LGY) Medium Grey (MGY)



Items with these symbols are available to ship in 2-3 days. Limited quantities and select colors.



(MGY)

# Sway Braces & Hinged Doors

## END SWAY BRACES (Sold in Pairs)

| CAT. NO.  | Shelf Depth | WT. | PRICE   |
|-----------|-------------|-----|---------|
| ESB-1224♣ | 12" to 24"  | 2.4 | \$14.10 |
| ESB-3036♣ | 30" to 36"  | 3.1 | 16.30   |

NOTE: Use two pair for uprights 96"-137"  
and three pair for uprights 138" and higher.

National Motor Freight Class: 70

Includes hardware.

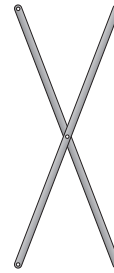

## REAR SWAY BRACES (Sold in Pairs)

| CAT. NO. | Unit Length | WT. | PRICE   |
|----------|-------------|-----|---------|
| RSBU♣    | 36" to 42"  | 3.2 | \$17.50 |
| RSB-48♣  | 48"         | 3.7 | 19.50   |

NOTE: Use two pair for uprights 96"-137"  
and three pair for uprights 138" and higher.

National Motor Freight Class: 70

Includes hardware.

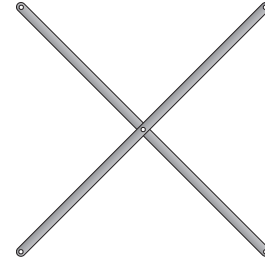

## HINGED DOOR SHELVING UNITS (8 Shelves, 7 Openings)

| CAT. NO.        | W  | D   | H  | WT. | PRICE      |
|-----------------|----|-----|----|-----|------------|
| HDS-8712RH-MGY♣ | 36 | 12* | 87 | 172 | \$1,224.00 |
| HDS-8718RH-MGY♣ | 36 | 18* | 87 | 197 | 1,346.00   |
| HDS-8724RH-MGY♣ | 36 | 24* | 87 | 221 | 1,464.00   |

\*Unit depth does not include 1 1/4" depth  
of door frame or 1/2" depth of handle.

NOTE: Hinged door shelving units available in Medium Grey only.

Hinged doors come standard with one recessed handle.

- Assembly required.

National Motor Freight Class: 70



## HINGED DOORS

| CAT. NO.                        | W  | D      | H  | WT. | PRICE    |
|---------------------------------|----|--------|----|-----|----------|
| <b>Full-Height Hinged Doors</b> |    |        |    |     |          |
| HD-3687RH-MGY♣                  | 36 | 1 1/4* | 87 | 63  | \$568.00 |

\* Depth does not include 1/2" depth of handle.

NOTE: Hinged doors available in medium grey only.

Hinged doors come standard with one recessed handle.

Assembly Required.

National Motor Freight Class: 70



SHELVING

### Standard Colors (Unless Otherwise Specified)



♣  
Items with this symbol are  
available to ship in 2-3 days.  
Limited quantities  
and select colors.



# L&T Preconfigured Units - 76" High

## 8 SHELVES, 7 OPENINGS

- Includes: Uprights (Two Closed "L" for Starter Units)  
OR (One Open "T" for Adder Units)  
Slotted steel shelves (22 gauge)  
Plain top shelf (22 gauge)  
Shelf supports  
Reinforcements (where noted)  
Backstops or centerstops  
Adjustable dividers  
Front base(s)  
Optional back available on page 90



Height to top of bottom shelf: 3"; shelf spaced 10 1/2" on center with 9 3/4" vertical filing space/opening.

- Assembly required.

| UNIT SIZE           |    |        | REINFORCEMENTS PER LEVEL | SHELF LOAD CAPACITY | NO. OF DIVIDERS/ OPENINGS | TOTAL FILING INCHES | STARTER UNITS |     |                   | ADDER UNITS  |     |                   |
|---------------------|----|--------|--------------------------|---------------------|---------------------------|---------------------|---------------|-----|-------------------|--------------|-----|-------------------|
| W                   | D  | H      |                          |                     |                           |                     | CAT NO.       | WT. | PRICE             | CAT NO.      | WT. | PRICE             |
| <b>Single Entry</b> |    |        |                          |                     |                           |                     |               |     |                   |              |     |                   |
| 30                  | 12 | 76 1/4 | —                        | 600                 | 4                         | 196                 | LCT-8-3012-6  | 110 | <b>\$807.00</b>   | TOT-8-3012-6 | 97  | <b>\$711.00</b>   |
| 36                  | 12 | 76 1/4 | —                        | 600                 | 4                         | 238                 | LCT-8-3612-6  | 122 | <b>809.00</b>     | TOT-8-3612-6 | 109 | <b>713.00</b>     |
| 42                  | 12 | 76 1/4 | —                        | 600                 | 4                         | 280                 | LCT-8-4212-6  | 151 | <b>991.00</b>     | TOT-8-4212-6 | 138 | <b>895.00</b>     |
| 48                  | 12 | 76 1/4 | —                        | 550                 | 5                         | 322                 | LCT-8-4812-6  | 170 | <b>1,077.00</b>   | TOT-8-4812-6 | 157 | <b>981.00</b>     |
| 30                  | 15 | 76 1/4 | —                        | 500                 | 4                         | 196                 | LCT-8-3015-6  | 120 | <b>877.00</b>     | TOT-8-3015-6 | 104 | <b>763.00</b>     |
| 36                  | 15 | 76 1/4 | —                        | 500                 | 4                         | 238                 | LCT-8-3615-6  | 132 | <b>879.00</b>     | TOT-8-3615-6 | 116 | <b>765.00</b>     |
| 42                  | 15 | 76 1/4 | —                        | 500                 | 4                         | 280                 | LCT-8-4215-6  | 162 | <b>1,073.00</b>   | TOT-8-4215-6 | 146 | <b>959.00</b>     |
| 48                  | 15 | 76 1/4 | —                        | 400                 | 5                         | 322                 | LCT-8-4815-6  | 183 | <b>1,168.00</b>   | TOT-8-4815-6 | 167 | <b>1,054.00</b>   |
| <b>Double Entry</b> |    |        |                          |                     |                           |                     |               |     |                   |              |     |                   |
| 30                  | 24 | 76 1/4 | 1                        | 400                 | 8                         | 392                 | LCT-8-3024-6  | 187 | <b>\$1,306.00</b> | TOT-8-3024-6 | 161 | <b>\$1,137.00</b> |
| 36                  | 24 | 76 1/4 | 1                        | 400                 | 8                         | 476                 | LCT-8-3624-6  | 205 | <b>1,313.00</b>   | TOT-8-3624-6 | 179 | <b>1,139.00</b>   |
| 42                  | 24 | 76 1/4 | 2                        | 500                 | 8                         | 560                 | LCT-8-4224-6  | 247 | <b>1,580.00</b>   | TOT-8-4224-6 | 221 | <b>1,406.00</b>   |
| 48                  | 24 | 76 1/4 | 2                        | 450                 | 10                        | 644                 | LCT-8-4824-6  | 278 | <b>1,723.00</b>   | TOT-8-4824-6 | 252 | <b>1,549.00</b>   |
| 30                  | 30 | 76 1/4 | 2                        | 400                 | 8                         | 392                 | LCT-8-3030-6  | 217 | <b>1,490.00</b>   | TOT-8-3030-6 | 186 | <b>1,291.00</b>   |
| 36                  | 30 | 76 1/4 | 2                        | 400                 | 8                         | 476                 | LCT-8-3630-6  | 239 | <b>1,558.00</b>   | TOT-8-3630-6 | 208 | <b>1,358.00</b>   |
| 42                  | 30 | 76 1/4 | 2                        | 450                 | 8                         | 560                 | LCT-8-4230-6  | 275 | <b>1,757.00</b>   | TOT-8-4230-6 | 245 | <b>1,557.00</b>   |
| 48                  | 30 | 76 1/4 | 2                        | 400                 | 10                        | 644                 | LCT-8-4830-6  | 310 | <b>1,942.00</b>   | TOT-8-4830-6 | 279 | <b>1,737.00</b>   |

No reinforcements are used on the top shelf.

## 7 SHELVES, 6 OPENINGS

- Includes: Uprights (Two Closed "L" for Starter Units)  
OR (One Open "T" for Adder Units)  
Slotted steel shelves (22 gauge)  
Plain top shelf (22 gauge)  
Shelf supports  
Reinforcements (where noted)  
Backstops or centerstops  
Adjustable dividers  
Front base(s)  
Optional back available on page 90

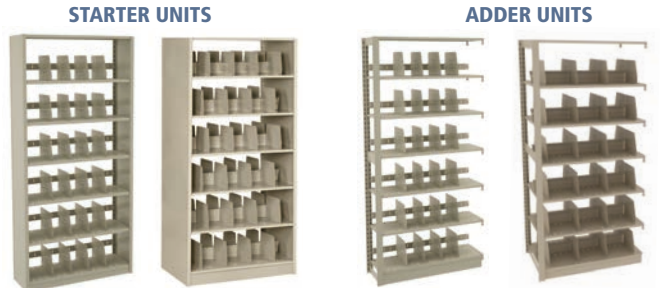

Height to top of bottom shelf: 4 1/2"; shelf spaced 12" on center with 11 1/4" vertical filing space/opening.

- Assembly required.

| UNIT SIZE           |    |        | REINFORCEMENTS PER LEVEL | SHELF LOAD CAPACITY | NO. OF DIVIDERS/ OPENINGS | TOTAL FILING INCHES | STARTER UNITS |     |                   | ADDER UNITS  |     |                   |
|---------------------|----|--------|--------------------------|---------------------|---------------------------|---------------------|---------------|-----|-------------------|--------------|-----|-------------------|
| W                   | D  | H      |                          |                     |                           |                     | CAT NO.       | WT. | PRICE             | CAT NO.      | WT. | PRICE             |
| <b>Single Entry</b> |    |        |                          |                     |                           |                     |               |     |                   |              |     |                   |
| 30                  | 12 | 76 1/4 | —                        | 600                 | 4                         | 168                 | LCT-7-3012-6  | 100 | <b>\$733.00</b>   | TOT-7-3012-6 | 86  | <b>\$637.00</b>   |
| 36                  | 12 | 76 1/4 | —                        | 600                 | 4                         | 204                 | LCT-7-3612-6  | 111 | <b>734.00</b>     | TOT-7-3612-6 | 97  | <b>638.00</b>     |
| 42                  | 12 | 76 1/4 | —                        | 600                 | 4                         | 240                 | LCT-7-4212-6  | 136 | <b>893.00</b>     | TOT-7-4212-6 | 122 | <b>797.00</b>     |
| 48                  | 12 | 76 1/4 | —                        | 550                 | 5                         | 276                 | LCT-7-4812-6  | 152 | <b>972.00</b>     | TOT-7-4812-6 | 139 | <b>876.00</b>     |
| 30                  | 15 | 76 1/4 | —                        | 500                 | 4                         | 168                 | LCT-7-3015-6  | 109 | <b>797.00</b>     | TOT-7-3015-6 | 92  | <b>679.00</b>     |
| 36                  | 15 | 76 1/4 | —                        | 500                 | 4                         | 204                 | LCT-7-3615-6  | 120 | <b>798.00</b>     | TOT-7-3615-6 | 103 | <b>684.00</b>     |
| 42                  | 15 | 76 1/4 | —                        | 500                 | 4                         | 240                 | LCT-7-4215-6  | 146 | <b>967.00</b>     | TOT-7-4215-6 | 130 | <b>853.00</b>     |
| 48                  | 15 | 76 1/4 | —                        | 400                 | 5                         | 276                 | LCT-7-4815-6  | 164 | <b>1,054.00</b>   | TOT-7-4815-6 | 148 | <b>940.00</b>     |
| <b>Double Entry</b> |    |        |                          |                     |                           |                     |               |     |                   |              |     |                   |
| 30                  | 24 | 76 1/4 | 1                        | 400                 | 8                         | 336                 | LCT-7-3024-6  | 169 | <b>\$1,181.00</b> | TOT-7-3024-6 | 143 | <b>\$1,007.00</b> |
| 36                  | 24 | 76 1/4 | 1                        | 400                 | 8                         | 408                 | LCT-7-3624-6  | 185 | <b>1,188.00</b>   | TOT-7-3624-6 | 159 | <b>1,014.00</b>   |
| 42                  | 24 | 76 1/4 | 2                        | 500                 | 8                         | 480                 | LCT-7-4224-6  | 221 | <b>1,417.00</b>   | TOT-7-4224-6 | 195 | <b>1,243.00</b>   |
| 48                  | 24 | 76 1/4 | 2                        | 450                 | 10                        | 552                 | LCT-7-4824-6  | 249 | <b>1,552.00</b>   | TOT-7-4824-6 | 223 | <b>1,369.00</b>   |
| 30                  | 30 | 76 1/4 | 2                        | 400                 | 8                         | 336                 | LCT-7-3030-6  | 195 | <b>1,404.00</b>   | TOT-7-3030-6 | 165 | <b>1,147.00</b>   |
| 36                  | 30 | 76 1/4 | 2                        | 400                 | 8                         | 408                 | LCT-7-3630-6  | 215 | <b>1,406.00</b>   | TOT-7-3630-6 | 184 | <b>1,206.00</b>   |
| 42                  | 30 | 76 1/4 | 2                        | 450                 | 8                         | 480                 | LCT-7-4230-6  | 247 | <b>1,579.00</b>   | TOT-7-4230-6 | 216 | <b>1,379.00</b>   |
| 48                  | 30 | 76 1/4 | 2                        | 400                 | 10                        | 552                 | LCT-7-4830-6  | 277 | <b>1,688.00</b>   | TOT-7-4830-6 | 246 | <b>1,538.00</b>   |

No reinforcements are used on the top shelf.

### Standard Colors



**Mobile Ready Units** - Any unit can be converted by substituting an "M" for the final dash in the catalog number. Example: LCT-8-3012-6 becomes LCT-8-3012M6. Pricing is identical; weight may vary slightly

SHELVING



# L&T Preconfigured Units - 88" High

## STARTER UNITS



## ADDER UNITS



## 9 SHELVES, 8 OPENINGS

- Includes:
- Uprights (Two Closed "L" for Starter Units)  
OR (One Open "T" for Adder Units)
  - Slotted steel shelves (22 gauge)
  - Plain top shelf (22 gauge)
  - Shelf supports
  - Reinforcements (where noted)
  - Backstops or centerstops
  - Adjustable dividers
  - Front base(s)
  - Optional back available on page 90

Height to top of bottom shelf: 4 1/2"; shelf spaced 10 1/2" on center with 9 3/4" vertical filing space/opening. - Assembly required.

| UNIT SIZE           |    | REINFORCEMENTS PER LEVEL | SHELF LOAD CAPACITY | NO. OF DIVIDERS/ OPENINGS | TOTAL FILING INCHES | STARTER UNITS |              |     | ADDER UNITS       |              |     |                   |
|---------------------|----|--------------------------|---------------------|---------------------------|---------------------|---------------|--------------|-----|-------------------|--------------|-----|-------------------|
| W                   | D  |                          |                     |                           |                     | H             | CAT NO.      | WT. | PRICE             | CAT NO.      | WT. | PRICE             |
| <b>Single Entry</b> |    |                          |                     |                           |                     |               |              |     |                   |              |     |                   |
| 30                  | 12 | 88 1/4                   | —                   | 600                       | 4                   | 224           | LCT-9-3012-7 | 126 | <b>\$921.00</b>   | TOT-9-3012-7 | 109 | <b>\$803.00</b>   |
| 36                  | 12 | 88 1/4                   | —                   | 600                       | 4                   | 272           | LCT-9-3612-7 | 140 | <b>923.00</b>     | TOT-9-3612-7 | 123 | <b>805.00</b>     |
| 42                  | 12 | 88 1/4                   | —                   | 600                       | 4                   | 320           | LCT-9-4212-7 | 172 | <b>1,126.00</b>   | TOT-9-4212-7 | 155 | <b>1,008.00</b>   |
| 48                  | 12 | 88 1/4                   | —                   | 550                       | 5                   | 368           | LCT-9-4812-7 | 194 | <b>1,228.00</b>   | TOT-9-4812-7 | 177 | <b>1,110.00</b>   |
| 30                  | 15 | 88 1/4                   | —                   | 500                       | 4                   | 224           | LCT-9-3015-7 | 136 | <b>1,007.00</b>   | TOT-9-3015-7 | 118 | <b>871.00</b>     |
| 36                  | 15 | 88 1/4                   | —                   | 500                       | 4                   | 272           | LCT-9-3615-7 | 150 | <b>1,009.00</b>   | TOT-9-3615-7 | 132 | <b>873.00</b>     |
| 42                  | 15 | 88 1/4                   | —                   | 500                       | 4                   | 320           | LCT-9-4215-7 | 184 | <b>1,226.00</b>   | TOT-9-4215-7 | 166 | <b>1,090.00</b>   |
| 48                  | 15 | 88 1/4                   | —                   | 400                       | 5                   | 368           | LCT-9-4815-7 | 208 | <b>1,338.00</b>   | TOT-9-4815-7 | 190 | <b>1,202.00</b>   |
| <b>Double Entry</b> |    |                          |                     |                           |                     |               |              |     |                   |              |     |                   |
| 30                  | 24 | 88 1/4                   | 1                   | 400                       | 8                   | 448           | LCT-9-3024-7 | 213 | <b>\$1,491.00</b> | TOT-9-3024-7 | 183 | <b>\$1,348.00</b> |
| 36                  | 24 | 88 1/4                   | 1                   | 400                       | 8                   | 544           | LCT-9-3624-7 | 233 | <b>1,492.00</b>   | TOT-9-3624-7 | 203 | <b>1,297.00</b>   |
| 42                  | 24 | 88 1/4                   | 2                   | 500                       | 8                   | 640           | LCT-9-4224-7 | 281 | <b>1,791.00</b>   | TOT-9-4224-7 | 251 | <b>1,596.00</b>   |
| 48                  | 24 | 88 1/4                   | 2                   | 450                       | 10                  | 736           | LCT-9-4824-7 | 316 | <b>1,964.00</b>   | TOT-9-4824-7 | 286 | <b>1,769.00</b>   |
| 30                  | 30 | 88 1/4                   | 2                   | 400                       | 8                   | 448           | LCT-9-3030-7 | 245 | <b>1,773.00</b>   | TOT-9-3030-7 | 212 | <b>1,536.00</b>   |
| 36                  | 30 | 88 1/4                   | 2                   | 400                       | 8                   | 544           | LCT-9-3630-7 | 270 | <b>1,775.00</b>   | TOT-9-3630-7 | 237 | <b>1,538.00</b>   |
| 42                  | 30 | 88 1/4                   | 2                   | 450                       | 8                   | 640           | LCT-9-4230-7 | 311 | <b>1,996.00</b>   | TOT-9-4230-7 | 278 | <b>1,759.00</b>   |
| 48                  | 30 | 88 1/4                   | 2                   | 400                       | 10                  | 736           | LCT-9-4830-7 | 350 | <b>2,216.00</b>   | TOT-9-4830-7 | 317 | <b>1,979.00</b>   |

No reinforcements are used on the top shelf.

## 8 SHELVES, 7 OPENINGS

### STARTER UNITS

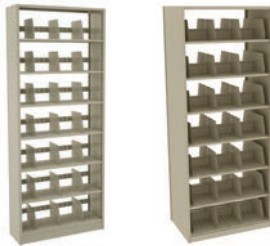

### ADDER UNITS

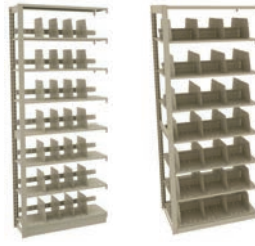

- Includes:
- Uprights (Two Closed "L" for Starter Units)  
OR (One Open "T" for Adder Units)
  - Slotted steel shelves (22 gauge)
  - Plain top shelf (22 gauge)
  - Shelf supports
  - Reinforcements (where noted)
  - Backstops or centerstops
  - Adjustable dividers
  - Front base(s)
  - Optional back available on page 90

Height to top of bottom shelf: 4 1/2"; shelf spaced 12" on center with 11 1/4" vertical filing space/opening. - Assembly required.

| UNIT SIZE           |    | REINFORCEMENTS PER LEVEL | SHELF LOAD CAPACITY | NO. OF DIVIDERS/ OPENINGS | TOTAL FILING INCHES | STARTER UNITS |              |     | ADDER UNITS       |              |     |                   |
|---------------------|----|--------------------------|---------------------|---------------------------|---------------------|---------------|--------------|-----|-------------------|--------------|-----|-------------------|
| W                   | D  |                          |                     |                           |                     | H             | CAT NO.      | WT. | PRICE             | CAT NO.      | WT. | PRICE             |
| <b>Single Entry</b> |    |                          |                     |                           |                     |               |              |     |                   |              |     |                   |
| 30                  | 12 | 88 1/4                   | —                   | 600                       | 4                   | 196           | LCT-8-3012-7 | 115 | <b>\$843.00</b>   | TOT-8-3012-7 | 98  | <b>\$725.00</b>   |
| 36                  | 12 | 88 1/4                   | —                   | 600                       | 4                   | 238           | LCT-8-3612-7 | 128 | <b>845.00</b>     | TOT-8-3612-7 | 111 | <b>727.00</b>     |
| 42                  | 12 | 88 1/4                   | —                   | 600                       | 4                   | 280           | LCT-8-4212-7 | 156 | <b>1,026.00</b>   | TOT-8-4212-7 | 139 | <b>908.00</b>     |
| 48                  | 12 | 88 1/4                   | —                   | 550                       | 5                   | 322           | LCT-8-4812-7 | 175 | <b>1,116.00</b>   | TOT-8-4812-7 | 158 | <b>998.00</b>     |
| 30                  | 15 | 88 1/4                   | —                   | 500                       | 4                   | 196           | LCT-8-3015-7 | 124 | <b>923.00</b>     | TOT-8-3015-7 | 106 | <b>787.00</b>     |
| 36                  | 15 | 88 1/4                   | —                   | 500                       | 4                   | 238           | LCT-8-3615-7 | 137 | <b>925.00</b>     | TOT-8-3615-7 | 119 | <b>789.00</b>     |
| 42                  | 15 | 88 1/4                   | —                   | 500                       | 4                   | 280           | LCT-8-4215-7 | 167 | <b>1,118.00</b>   | TOT-8-4215-7 | 149 | <b>982.00</b>     |
| 48                  | 15 | 88 1/4                   | —                   | 400                       | 5                   | 322           | LCT-8-4815-7 | 188 | <b>1,217.00</b>   | TOT-8-4815-7 | 170 | <b>1,081.00</b>   |
| <b>Double Entry</b> |    |                          |                     |                           |                     |               |              |     |                   |              |     |                   |
| 30                  | 24 | 88 1/4                   | 1                   | 400                       | 8                   | 392           | LCT-8-3024-7 | 194 | <b>\$1,353.00</b> | TOT-8-3024-7 | 164 | <b>\$1,159.00</b> |
| 36                  | 24 | 88 1/4                   | 1                   | 400                       | 8                   | 476           | LCT-8-3624-7 | 212 | <b>1,360.00</b>   | TOT-8-3624-7 | 182 | <b>1,165.00</b>   |
| 42                  | 24 | 88 1/4                   | 2                   | 500                       | 8                   | 560           | LCT-8-4224-7 | 254 | <b>1,626.00</b>   | TOT-8-4224-7 | 224 | <b>1,431.00</b>   |
| 48                  | 24 | 88 1/4                   | 2                   | 450                       | 10                  | 644           | LCT-8-4824-7 | 285 | <b>1,778.00</b>   | TOT-8-4824-7 | 255 | <b>1,583.00</b>   |
| 30                  | 30 | 88 1/4                   | 2                   | 400                       | 8                   | 392           | LCT-8-3030-7 | 223 | <b>1,548.00</b>   | TOT-8-3030-7 | 190 | <b>1,164.00</b>   |
| 36                  | 30 | 88 1/4                   | 2                   | 400                       | 8                   | 476           | LCT-8-3630-7 | 245 | <b>1,615.00</b>   | TOT-8-3630-7 | 212 | <b>1,378.00</b>   |
| 42                  | 30 | 88 1/4                   | 2                   | 450                       | 8                   | 560           | LCT-8-4230-7 | 282 | <b>1,813.00</b>   | TOT-8-4230-7 | 249 | <b>1,576.00</b>   |
| 48                  | 30 | 88 1/4                   | 2                   | 400                       | 10                  | 644           | LCT-8-4830-7 | 316 | <b>2,007.00</b>   | TOT-8-4830-7 | 283 | <b>1,770.00</b>   |

No reinforcements are used on the top shelf.

### Standard Colors



**Mobile Ready Units** - Any unit can be converted by substituting an "M" for the final dash in the catalog number. Example: LCT-8-3012-6 becomes LCT-8-3012M6. Pricing is identical; weight may vary slightly

# Open Uprights

## USE FOR ROW ENDS

## USE FOR INTERMEDIATE POSTS

All open "L" uprights are 1 1/8" wide.

All open "T" uprights are 2" wide.



| CAT. NO. | PCS/CTN | D  | H      | WT.  | PRICE   |
|----------|---------|----|--------|------|---------|
| 1240LO   | 4       | 12 | 40 1/4 | 5.8  | \$67.00 |
| 1540LO   | 4       | 15 | 40 1/4 | 6.4  | 67.00   |
| 0964LO   | 6       | 9  | 64 1/4 | 8.5  | 84.00   |
| 1264LO   | 4       | 12 | 64 1/4 | 8.9  | 84.00   |
| 1564LO   | 4       | 15 | 64 1/4 | 9.7  | 89.00   |
| 1864LO   | 4       | 18 | 64 1/4 | 10.0 | 89.00   |
| 2464LO   | 4       | 24 | 64 1/4 | 11.0 | 92.00   |
| 3064LO   | 4       | 30 | 64 1/4 | 12.0 | 91.00   |
| 3664LO   | 4       | 36 | 64 1/4 | 13.0 | 97.00   |
| 0976LO   | 4       | 9  | 76 1/4 | 9.6  | 91.00   |
| 1076LO   | 4       | 10 | 76 1/4 | 9.7  | 92.00   |
| 1276LO   | 6       | 12 | 76 1/4 | 9.9  | 92.00   |
| 1376LO   | 4       | 13 | 76 1/4 | 9.9  | 92.00   |
| 1576LO   | 6       | 15 | 76 1/4 | 10.0 | 92.00   |
| 1676LO   | 4       | 16 | 76 1/4 | 10.3 | 95.00   |
| 1876LO   | 4       | 18 | 76 1/4 | 11.0 | 95.00   |
| 2076LO   | 4       | 20 | 76 1/4 | 11.3 | 99.00   |
| 2476LO   | 4       | 24 | 76 1/4 | 12.0 | 99.00   |
| 2676LO   | 4       | 26 | 76 1/4 | 12.4 | 111.00  |
| 3076LO   | 4       | 30 | 76 1/4 | 13.3 | 111.00  |
| 3276LO   | 4       | 32 | 76 1/4 | 14.0 | 119.00  |
| 3676LO   | 4       | 36 | 76 1/4 | 14.0 | 119.00  |
| 0985LO   | 4       | 9  | 85 1/4 | 10.0 | 108.00  |
| 1085LO   | 4       | 10 | 85 1/4 | 10.3 | 102.00  |
| 1285LO   | 6       | 12 | 85 1/4 | 11.0 | 102.00  |
| 1385LO   | 4       | 13 | 85 1/4 | 11.0 | 102.00  |
| 1585LO   | 6       | 15 | 85 1/4 | 11.0 | 102.00  |
| 1685LO   | 4       | 16 | 85 1/4 | 11.3 | 108.00  |
| 1885LO   | 4       | 18 | 85 1/4 | 12.0 | 108.00  |
| 2085LO   | 4       | 20 | 85 1/4 | 12.3 | 116.00  |
| 2485LO   | 4       | 24 | 85 1/4 | 13.0 | 116.00  |
| 2685LO   | 4       | 26 | 85 1/4 | 13.3 | 124.00  |
| 3085LO   | 4       | 30 | 85 1/4 | 14.0 | 124.00  |
| 3285LO   | 4       | 32 | 85 1/4 | 14.3 | 154.00  |
| 3685LO   | 4       | 36 | 85 1/4 | 15.0 | 154.00  |
| 0988LO   | 4       | 9  | 88 1/4 | 11.0 | 102.00  |
| 1088LO   | 4       | 10 | 88 1/4 | 11.0 | 102.00  |
| 1288LO   | 6       | 12 | 88 1/4 | 11.0 | 102.00  |
| 1388LO   | 4       | 13 | 88 1/4 | 11.0 | 104.00  |
| 1588LO   | 6       | 15 | 88 1/4 | 11.0 | 104.00  |
| 1688LO   | 4       | 16 | 88 1/4 | 13.0 | 105.00  |
| 1888LO   | 4       | 18 | 88 1/4 | 13.0 | 105.00  |
| 2088LO   | 4       | 20 | 88 1/4 | 13.3 | 115.00  |
| 2488LO   | 4       | 24 | 88 1/4 | 14.0 | 115.00  |
| 2688LO   | 4       | 26 | 88 1/4 | 14.3 | 122.00  |
| 3088LO   | 4       | 30 | 88 1/4 | 15.0 | 122.00  |
| 3288LO   | 4       | 32 | 88 1/4 | 16.0 | 136.00  |
| 3688LO   | 4       | 36 | 88 1/4 | 16.0 | 136.00  |
| 0997LO   | 4       | 9  | 97 1/4 | 12.0 | 115.00  |
| 1297LO   | 4       | 12 | 97 1/4 | 13.0 | 111.00  |
| 1597LO   | 4       | 15 | 97 1/4 | 14.0 | 124.00  |
| 1897LO   | 4       | 18 | 97 1/4 | 15.0 | 131.00  |
| 2497LO   | 4       | 24 | 97 1/4 | 17.0 | 132.00  |
| 3097LO   | 4       | 30 | 97 1/4 | 17.0 | 148.00  |
| 3697LO   | 4       | 36 | 97 1/4 | 18.0 | 165.00  |

| CAT. NO. | PCS/CTN | D  | H      | WT.  | PRICE   |
|----------|---------|----|--------|------|---------|
| 1240TO   | 3       | 12 | 40 1/4 | 7.9  | \$80.00 |
| 1540TO   | 3       | 15 | 40 1/4 | 8.6  | 82.00   |
| 0964TO   | 6       | 9  | 64 1/4 | 11.0 | 99.00   |
| 1264TO   | 3       | 12 | 64 1/4 | 12.0 | 102.00  |
| 1564TO   | 3       | 15 | 64 1/4 | 13.0 | 108.00  |
| 1864TO   | 3       | 18 | 64 1/4 | 14.0 | 109.00  |
| 2464TO   | 3       | 24 | 64 1/4 | 14.7 | 118.00  |
| 3064TO   | 3       | 30 | 64 1/4 | 15.0 | 122.00  |
| 3664TO   | 3       | 36 | 64 1/4 | 16.0 | 114.00  |
| 0976TO   | 6       | 9  | 76 1/4 | 13.4 | 104.00  |
| 1076TO   | 4       | 10 | 76 1/4 | 13.6 | 108.00  |
| 1276TO   | 4       | 12 | 76 1/4 | 14.0 | 108.00  |
| 1376TO   | 4       | 13 | 76 1/4 | 13.7 | 108.00  |
| 1576TO   | 4       | 15 | 76 1/4 | 13.7 | 108.00  |
| 1676TO   | 3       | 16 | 76 1/4 | 14.2 | 112.00  |
| 1876TO   | 3       | 18 | 76 1/4 | 16.0 | 112.00  |
| 2076TO   | 3       | 20 | 76 1/4 | 16.0 | 124.00  |
| 2476TO   | 3       | 24 | 76 1/4 | 16.0 | 124.00  |
| 2676TO   | 3       | 26 | 76 1/4 | 16.7 | 136.00  |
| 3076TO   | 3       | 30 | 76 1/4 | 18.0 | 136.00  |
| 3276TO   | 3       | 32 | 76 1/4 | 16.0 | 151.00  |
| 3676TO   | 3       | 36 | 76 1/4 | 18.0 | 151.00  |
| 0985TO   | 6       | 9  | 85 1/4 | 12.1 | 119.00  |
| 1085TO   | 4       | 10 | 85 1/4 | 13.1 | 118.00  |
| 1285TO   | 4       | 12 | 85 1/4 | 15.0 | 118.00  |
| 1385TO   | 4       | 13 | 85 1/4 | 15.3 | 124.00  |
| 1585TO   | 4       | 15 | 85 1/4 | 16.0 | 124.00  |
| 1685TO   | 3       | 16 | 85 1/4 | 16.3 | 129.00  |
| 1885TO   | 3       | 18 | 85 1/4 | 17.0 | 129.00  |
| 2085TO   | 3       | 20 | 85 1/4 | 17.7 | 141.00  |
| 2485TO   | 3       | 24 | 85 1/4 | 19.0 | 141.00  |
| 2685TO   | 3       | 26 | 85 1/4 | 19.1 | 151.00  |
| 3085TO   | 3       | 30 | 85 1/4 | 19.3 | 151.00  |
| 3285TO   | 3       | 32 | 85 1/4 | 20.0 | 163.00  |
| 3685TO   | 4       | 36 | 85 1/4 | 22.0 | 163.00  |
| 0988TO   | 6       | 9  | 88 1/4 | 15.0 | 119.00  |
| 1088TO   | 4       | 10 | 88 1/4 | 15.0 | 118.00  |
| 1288TO   | 4       | 12 | 88 1/4 | 15.0 | 118.00  |
| 1388TO   | 4       | 13 | 88 1/4 | 16.0 | 128.00  |
| 1588TO   | 4       | 15 | 88 1/4 | 16.0 | 128.00  |
| 1688TO   | 3       | 16 | 88 1/4 | 18.0 | 131.00  |
| 1888TO   | 3       | 18 | 88 1/4 | 18.0 | 131.00  |
| 2088TO   | 3       | 20 | 88 1/4 | 18.0 | 143.00  |
| 2488TO   | 3       | 24 | 88 1/4 | 18.0 | 143.00  |
| 2688TO   | 3       | 26 | 88 1/4 | 19.0 | 149.00  |
| 3088TO   | 3       | 30 | 88 1/4 | 21.0 | 149.00  |
| 3288TO   | 3       | 32 | 88 1/4 | 23.0 | 162.00  |
| 3688TO   | 4       | 36 | 88 1/4 | 23.0 | 162.00  |
| 0997TO   | 6       | 9  | 97 1/4 | 17.0 | 142.00  |
| 1297TO   | 3       | 12 | 97 1/4 | 18.0 | 136.00  |
| 1597TO   | 3       | 15 | 97 1/4 | 19.0 | 149.00  |
| 1897TO   | 3       | 18 | 97 1/4 | 19.0 | 156.00  |
| 2497TO   | 3       | 24 | 97 1/4 | 21.0 | 163.00  |
| 3097TO   | 3       | 30 | 97 1/4 | 22.0 | 178.00  |
| 3697TO   | 3       | 36 | 97 1/4 | 23.0 | 195.00  |

Top

Top

Bottom

Bottom

Custom heights and/or custom punch spacing on uprights are available on orders of a single size in quantities of 50 pieces or more and/or orders of multiple sizes in quantities of 200 pieces or more. Call factory for pricing.

### Standard Colors



Sand (SND) Champagne/ Putty (CPY) Light Grey (LGY) Medium Grey (MGY) Black (BLK)

# Closed Uprights

## USE FOR ROW ENDS

| CAT. NO. | PCS/CTN | D  | H       | WT.  | PRICE   |
|----------|---------|----|---------|------|---------|
| 1240LC   | 4       | 12 | 40 1/4  | 7.8  | \$82.00 |
| 1540LC   | 4       | 15 | 40 1/4  | 9.0  | 84.00   |
| 1840LC   | 4       | 18 | 40 1/4  | 10.1 | 92.00   |
| 2440LC   | 4       | 24 | 40 1/4  | 12.0 | 104.00  |
| 3040LC   | 4       | 30 | 40 1/4  | 14.0 | 111.00  |
| 3640LC   | 4       | 36 | 40 1/4  | 16.0 | 122.00  |
| 0964LC   | 6       | 9  | 64 1/4  | 11.0 | 97.00   |
| 1264LC   | 4       | 12 | 64 1/4  | 12.0 | 99.00   |
| 1564LC   | 4       | 15 | 64 1/4  | 14.0 | 109.00  |
| 1864LC   | 4       | 18 | 64 1/4  | 15.0 | 116.00  |
| 2464LC   | 4       | 24 | 64 1/4  | 19.0 | 119.00  |
| 3064LC   | 4       | 30 | 64 1/4  | 21.0 | 153.00  |
| 3664LC   | 4       | 36 | 64 1/4  | 24.0 | 156.00  |
| 0976LC   | 4       | 9  | 76 1/4  | 13.0 | 105.00  |
| 1076LC   | 4       | 10 | 76 1/4  | 13.7 | 102.00  |
| 1276LC   | 6       | 12 | 76 1/4  | 13.7 | 102.00  |
| 1376LC   | 4       | 13 | 76 1/4  | 14.1 | 111.00  |
| 1576LC   | 6       | 15 | 76 1/4  | 15.0 | 111.00  |
| 1676LC   | 4       | 16 | 76 1/4  | 15.1 | 128.00  |
| 1876LC   | 4       | 18 | 76 1/4  | 17.0 | 128.00  |
| 2076LC   | 4       | 20 | 76 1/4  | 21.0 | 149.00  |
| 2476LC   | 4       | 24 | 76 1/4  | 21.0 | 149.00  |
| 2676LC   | 4       | 26 | 76 1/4  | 22.0 | 163.00  |
| 3076LC   | 4       | 30 | 76 1/4  | 24.3 | 168.00  |
| 3276LC   | 4       | 32 | 76 1/4  | 25.0 | 190.00  |
| 3676LC   | 4       | 36 | 76 1/4  | 28.0 | 190.00  |
| 0985LC   | 4       | 9  | 85 1/4  | 14.0 | 122.00  |
| 1085LC   | 4       | 10 | 85 1/4  | 15.0 | 118.00  |
| 1285LC   | 6       | 12 | 85 1/4  | 15.0 | 118.00  |
| 1385LC   | 4       | 13 | 85 1/4  | 17.0 | 131.00  |
| 1585LC   | 6       | 15 | 85 1/4  | 17.0 | 131.00  |
| 1685LC   | 4       | 16 | 85 1/4  | 17.7 | 145.00  |
| 1885LC   | 4       | 18 | 85 1/4  | 19.0 | 145.00  |
| 2085LC   | 4       | 20 | 85 1/4  | 20.0 | 169.00  |
| 2485LC   | 4       | 24 | 85 1/4  | 23.0 | 169.00  |
| 2685LC   | 4       | 26 | 85 1/4  | 24.0 | 189.00  |
| 3085LC   | 4       | 30 | 85 1/4  | 27.0 | 189.00  |
| 3285LC   | 4       | 32 | 85 1/4  | 31.0 | 219.00  |
| 3685LC   | 4       | 36 | 85 1/4  | 30.0 | 219.00  |
| 0988LC   | 4       | 9  | 88 1/4  | 14.0 | 122.00  |
| 1088LC   | 4       | 10 | 88 1/4  | 16.0 | 118.00  |
| 1288LC   | 6       | 12 | 88 1/4  | 16.0 | 118.00  |
| 1388LC   | 6       | 13 | 88 1/4  | 17.0 | 132.00  |
| 1588LC   | 6       | 15 | 88 1/4  | 17.0 | 132.00  |
| 1688LC   | 4       | 16 | 88 1/4  | 20.0 | 148.00  |
| 1888LC   | 4       | 18 | 88 1/4  | 20.0 | 148.00  |
| 2088LC   | 4       | 20 | 88 1/4  | 24.0 | 169.00  |
| 2488LC   | 4       | 24 | 88 1/4  | 24.0 | 169.00  |
| 2688LC   | 4       | 26 | 88 1/4  | 25.0 | 193.00  |
| 3088LC   | 4       | 30 | 88 1/4  | 27.0 | 193.00  |
| 3288LC   | 4       | 32 | 88 1/4  | 31.0 | 214.00  |
| 3688LC   | 4       | 36 | 88 1/4  | 31.0 | 214.00  |
| 0997LC   | 4       | 9  | 97 1/4  | 16.0 | 136.00  |
| 1297LC   | 4       | 12 | 97 1/4  | 18.0 | 141.00  |
| 1597LC   | 4       | 15 | 97 1/4  | 21.0 | 165.00  |
| 1897LC   | 4       | 18 | 97 1/4  | 23.0 | 169.00  |
| 2497LC   | 4       | 24 | 97 1/4  | 27.0 | 199.00  |
| 3097LC   | 4       | 30 | 97 1/4  | 31.0 | 231.00  |
| 3697LC   | 4       | 36 | 97 1/4  | 35.0 | 266.00  |
| 12121LC  | 4       | 12 | 121 1/4 | 23.0 | 175.00  |
| 15121LC  | 4       | 15 | 121 1/4 | 26.0 | 190.00  |
| 18121LC  | 4       | 18 | 121 1/4 | 28.0 | 207.00  |
| 24121LC  | 4       | 24 | 121 1/4 | 34.0 | 234.00  |
| 30121LC  | 4       | 30 | 121 1/4 | 39.0 | 273.00  |
| 36121LC  | 4       | 36 | 121 1/4 | 44.0 | 311.00  |

All closed "L" uprights are 1 1/8" wide.



## USE FOR INTERMEDIATE POSTS

| CAT. NO. | PCS/CTN | D  | H       | WT.  | PRICE   |
|----------|---------|----|---------|------|---------|
| 1240TC   | 3       | 12 | 40 1/4  | 10.0 | \$95.00 |
| 1540TC   | 3       | 15 | 40 1/4  | 11.0 | 99.00   |
| 1840TC   | 3       | 18 | 40 1/4  | 12.0 | 105.00  |
| 2440TC   | 3       | 24 | 40 1/4  | 14.0 | 116.00  |
| 3040TC   | 3       | 30 | 40 1/4  | 16.0 | 122.00  |
| 3640TC   | 3       | 36 | 40 1/4  | 18.0 | 131.00  |
| 0964TC   | 6       | 9  | 64 1/4  | 14.0 | 111.00  |
| 1264TC   | 3       | 12 | 64 1/4  | 16.0 | 116.00  |
| 1564TC   | 3       | 15 | 64 1/4  | 17.0 | 128.00  |
| 1864TC   | 3       | 18 | 64 1/4  | 18.5 | 136.00  |
| 2464TC   | 3       | 24 | 64 1/4  | 22.0 | 158.00  |
| 3064TC   | 3       | 30 | 64 1/4  | 25.0 | 176.00  |
| 3664TC   | 3       | 36 | 64 1/4  | 28.0 | 175.00  |
| 0976TC   | 6       | 9  | 76 1/4  | 16.6 | 118.00  |
| 1076TC   | 4       | 10 | 76 1/4  | 17.1 | 131.00  |
| 1276TC   | 4       | 12 | 76 1/4  | 18.0 | 131.00  |
| 1376TC   | 4       | 13 | 76 1/4  | 18.3 | 132.00  |
| 1576TC   | 4       | 15 | 76 1/4  | 19.0 | 132.00  |
| 1676TC   | 3       | 16 | 76 1/4  | 20.0 | 145.00  |
| 1876TC   | 3       | 18 | 76 1/4  | 22.0 | 145.00  |
| 2076TC   | 3       | 20 | 76 1/4  | 23.0 | 173.00  |
| 2476TC   | 3       | 24 | 76 1/4  | 25.0 | 173.00  |
| 2676TC   | 3       | 26 | 76 1/4  | 26.0 | 193.00  |
| 3076TC   | 3       | 30 | 76 1/4  | 29.0 | 193.00  |
| 3276TC   | 3       | 32 | 76 1/4  | 30.0 | 195.00  |
| 3676TC   | 3       | 36 | 76 1/4  | 32.0 | 203.00  |
| 0985TC   | 6       | 9  | 85 1/4  | 18.0 | 136.00  |
| 1085TC   | 4       | 10 | 85 1/4  | 20.0 | 145.00  |
| 1285TC   | 4       | 12 | 85 1/4  | 20.0 | 145.00  |
| 1385TC   | 4       | 13 | 85 1/4  | 20.0 | 156.00  |
| 1585TC   | 4       | 15 | 85 1/4  | 21.0 | 156.00  |
| 1685TC   | 3       | 16 | 85 1/4  | 22.0 | 169.00  |
| 1885TC   | 3       | 18 | 85 1/4  | 24.0 | 169.00  |
| 2085TC   | 3       | 20 | 85 1/4  | 26.0 | 196.00  |
| 2485TC   | 3       | 24 | 85 1/4  | 29.0 | 196.00  |
| 2685TC   | 3       | 26 | 85 1/4  | 30.0 | 226.00  |
| 3085TC   | 3       | 30 | 85 1/4  | 32.0 | 226.00  |
| 3285TC   | 3       | 32 | 85 1/4  | 37.0 | 246.00  |
| 3685TC   | 3       | 36 | 85 1/4  | 37.0 | 246.00  |
| 0988TC   | 6       | 9  | 88 1/4  | 19.0 | 141.00  |
| 1088TC   | 4       | 10 | 88 1/4  | 20.0 | 145.00  |
| 1288TC   | 4       | 12 | 88 1/4  | 20.0 | 145.00  |
| 1388TC   | 4       | 13 | 88 1/4  | 22.0 | 156.00  |
| 1588TC   | 4       | 15 | 88 1/4  | 22.0 | 156.00  |
| 1688TC   | 3       | 16 | 88 1/4  | 25.0 | 173.00  |
| 1888TC   | 3       | 18 | 88 1/4  | 25.0 | 173.00  |
| 2088TC   | 3       | 20 | 88 1/4  | 26.0 | 199.00  |
| 2488TC   | 3       | 24 | 88 1/4  | 29.0 | 199.00  |
| 2688TC   | 3       | 26 | 88 1/4  | 30.0 | 226.00  |
| 3088TC   | 3       | 30 | 88 1/4  | 33.0 | 226.00  |
| 3288TC   | 3       | 32 | 88 1/4  | 38.0 | 246.00  |
| 3688TC   | 3       | 36 | 88 1/4  | 38.0 | 246.00  |
| 0997TC   | 6       | 9  | 97 1/4  | 21.0 | 165.00  |
| 1297TC   | 3       | 12 | 97 1/4  | 23.0 | 169.00  |
| 1597TC   | 3       | 15 | 97 1/4  | 25.0 | 196.00  |
| 1897TC   | 3       | 18 | 97 1/4  | 28.0 | 199.00  |
| 2497TC   | 3       | 24 | 97 1/4  | 32.0 | 227.00  |
| 3097TC   | 3       | 30 | 97 1/4  | 37.0 | 267.00  |
| 3697TC   | 3       | 36 | 97 1/4  | 41.0 | 298.00  |
| 12121TC  | 3       | 12 | 121 1/4 | 21.0 | 210.00  |
| 15121TC  | 3       | 15 | 121 1/4 | 32.0 | 229.00  |
| 18121TC  | 3       | 18 | 121 1/4 | 35.0 | 246.00  |
| 24121TC  | 3       | 24 | 121 1/4 | 40.0 | 271.00  |
| 30121TC  | 3       | 30 | 121 1/4 | 46.0 | 320.00  |
| 36121TC  | 3       | 36 | 121 1/4 | 51.0 | 358.00  |

All closed "T" uprights are 2" wide.



SHELVING

Custom heights and/or custom punch spacing on uprights are available on orders of a single size in quantities of 50 pieces or more and/or orders of multiple sizes in quantities of 200 pieces or more. Call factory for pricing.

### Standard Colors



Sand (SND) Champagne/ Putty (CPY) Light Grey (LGY) Medium Grey (MGY) Black (BLK)

# Thin Profile Shelves (No Slots)

## THIN PROFILE SHELVES - 22 GAUGE



| CAT. NO. | LOAD CAP.* | Recommended Reinforcements | PCS/ CTN | W  | D  | H     | WT.  | PRICE   |
|----------|------------|----------------------------|----------|----|----|-------|------|---------|
| T2-2412  | 600        | —                          | 16       | 24 | 12 | 25/32 | 3.1  | \$28.00 |
| T2-2415  | 500        | —                          | 16       | 24 | 15 | 25/32 | 3.8  | 38.00   |
| T2-2424  | 400        | 1                          | 8        | 24 | 24 | 25/32 | 5.8  | 53.00   |
| T2-2430  | 400        | 2                          | 8        | 24 | 30 | 25/32 | 7.2  | 70.00   |
| T2-3010  | 600        | —                          | 8        | 30 | 10 | 25/32 | 3.2  | 28.00   |
| T2-3012  | 600        | —                          | 8        | 30 | 12 | 25/32 | 3.8  | 28.00   |
| T2-3013  | 500        | —                          | 8        | 30 | 13 | 25/32 | 4.1  | 38.00   |
| T2-3015  | 500        | —                          | 8        | 30 | 15 | 25/32 | 4.7  | 38.00   |
| T2-3016  | 500        | 1                          | 8        | 30 | 16 | 25/32 | 4.9  | 44.00   |
| T2-3018  | 500        | 1                          | 8        | 30 | 18 | 25/32 | 5.5  | 44.00   |
| T2-3020  | 400        | 1                          | 8        | 30 | 20 | 25/32 | 6.1  | 53.00   |
| T2-3024  | 400        | 1                          | 8        | 30 | 24 | 25/32 | 7.2  | 53.00   |
| T2-3026  | 400        | 2                          | 8        | 30 | 26 | 25/32 | 7.7  | 70.00   |
| T2-3030  | 400        | 2                          | 8        | 30 | 30 | 25/32 | 8.8  | 70.00   |
| T2-3032  | 400        | 2                          | 8        | 30 | 32 | 25/32 | 9.4  | 80.00   |
| T2-3609  | 600        | —                          | 16       | 36 | 9  | 25/32 | 3.6  | 31.00   |
| T2-3610  | 600        | —                          | 16       | 36 | 10 | 25/32 | 3.9  | 28.00   |
| T2-3612  | 600        | —                          | 16       | 36 | 12 | 25/32 | 4.6  | 28.00   |
| T2-3613  | 500        | —                          | 8        | 36 | 13 | 25/32 | 4.6  | 38.00   |
| T2-3615  | 500        | —                          | 8        | 36 | 15 | 25/32 | 5.5  | 38.00   |
| T2-3616  | 500        | 1                          | 8        | 36 | 16 | 25/32 | 5.9  | 44.00   |
| T2-3618  | 500        | 1                          | 8        | 36 | 18 | 25/32 | 6.5  | 44.00   |
| T2-3620  | 400        | 1                          | 8        | 36 | 20 | 25/32 | 7.2  | 53.00   |
| T2-3624  | 400        | 1                          | 8        | 36 | 24 | 25/32 | 8.5  | 53.00   |
| T2-3626  | 400        | 2                          | 8        | 36 | 26 | 25/32 | 9.2  | 70.00   |
| T2-3630  | 400        | 2                          | 8        | 36 | 30 | 25/32 | 10.5 | 70.00   |
| T2-3632  | 400        | 2                          | 8        | 36 | 32 | 25/32 | 11.1 | 80.00   |

| CAT. NO. | LOAD CAP.* | Recommended Reinforcements | PCS/ CTN | W  | D  | H     | WT.  | PRICE   |
|----------|------------|----------------------------|----------|----|----|-------|------|---------|
| T2-4209  | 600        | —                          | 16       | 42 | 9  | 25/32 | 4.1  | \$31.00 |
| T2-4210  | 600        | —                          | 12       | 42 | 10 | 25/32 | 4.5  | 36.00   |
| T2-4212  | 600        | —                          | 12       | 42 | 12 | 25/32 | 5.3  | 36.00   |
| T2-4213  | 500        | —                          | 8        | 42 | 13 | 25/32 | 5.7  | 44.00   |
| T2-4215  | 500        | —                          | 8        | 42 | 15 | 25/32 | 6.4  | 44.00   |
| T2-4216  | 500        | 1                          | 8        | 42 | 16 | 25/32 | 6.8  | 53.00   |
| T2-4218  | 500        | 1                          | 8        | 42 | 18 | 25/32 | 7.6  | 53.00   |
| T2-4220  | 500        | 1                          | 8        | 42 | 20 | 25/32 | 8.3  | 64.00   |
| T2-4224  | 500        | 1                          | 8        | 42 | 24 | 25/32 | 9.8  | 64.00   |
| T2-4226  | 450        | 2                          | 8        | 42 | 26 | 25/32 | 10.6 | 77.00   |
| T2-4230  | 450        | 2                          | 8        | 42 | 30 | 25/32 | 12.0 | 77.00   |
| T2-4232  | 450        | 2                          | 8        | 42 | 32 | 25/32 | 12.8 | 82.00   |
| T2-4809  | 550        | —                          | 16       | 48 | 9  | 25/32 | 4.7  | 41.00   |
| T2-4810  | 550        | —                          | 12       | 48 | 10 | 25/32 | 5.1  | 40.00   |
| T2-4812  | 550        | —                          | 12       | 48 | 12 | 25/32 | 6.0  | 40.00   |
| T2-4813  | 400        | —                          | 8        | 48 | 13 | 25/32 | 6.4  | 50.00   |
| T2-4815  | 400        | —                          | 8        | 48 | 15 | 25/32 | 7.3  | 50.00   |
| T2-4816  | 350        | 1                          | 8        | 48 | 16 | 25/32 | 7.7  | 57.00   |
| T2-4818  | 350        | 1                          | 8        | 48 | 18 | 25/32 | 8.6  | 57.00   |
| T2-4820  | 450        | 2                          | 8        | 48 | 20 | 25/32 | 9.5  | 67.00   |
| T2-4824  | 450        | 2                          | 8        | 48 | 24 | 25/32 | 11.2 | 67.00   |
| T2-4826  | 400        | 2                          | 8        | 48 | 26 | 25/32 | 12.1 | 87.00   |
| T2-4830  | 400        | 2                          | 6        | 48 | 30 | 25/32 | 13.8 | 87.00   |
| T2-4832  | 400        | 2                          | 6        | 48 | 32 | 25/32 | 14.7 | 98.00   |

For use with all uprights except double wall (library) uprights. Each shelf requires two shelf supports. Load capacities are based on using the recommended number of TR-dd reinforcements and on using TS-wwgg shelf supports, with weight evenly distributed. Shelves punched for optional center dividers (CD-ww). If using SHS supports, HR-dd reinforcements are required. \*NOTE: Load capacities do not apply to mobile units.

## THIN PROFILE SHELVES - 18 GAUGE

| CAT. NO. | LOAD CAP.* | Recommended Reinforcements | PCS/ CTN | W  | D  | H     | WT.  | PRICE  |
|----------|------------|----------------------------|----------|----|----|-------|------|--------|
| T-3012   | 600        | —                          | 16       | 30 | 12 | 25/32 | 5.4  | 53.00  |
| T-3015   | 500        | —                          | 8        | 30 | 15 | 25/32 | 8.2  | 70.00  |
| T-3024   | 400        | 1                          | 8        | 30 | 24 | 25/32 | 13.0 | 95.00  |
| T-3030   | 500        | 2                          | 8        | 30 | 30 | 25/32 | 16.8 | 99.00  |
| T-3609   | 600        | —                          | 16       | 36 | 9  | 25/32 | 5.7  | 51.00  |
| T-3612   | 600        | —                          | 16       | 36 | 12 | 25/32 | 7.3  | 53.00  |
| T-3615   | 500        | —                          | 8        | 36 | 15 | 25/32 | 8.9  | 70.00  |
| T-3618   | 500        | 1                          | 8        | 36 | 18 | 25/32 | 10.5 | 67.00  |
| T-3624   | 400        | 1                          | 8        | 36 | 24 | 25/32 | 13.6 | 95.00  |
| T-3630   | 500        | 2                          | 8        | 36 | 30 | 25/32 | 18.0 | 111.00 |
| T-4209   | 600        | —                          | 16       | 42 | 9  | 25/32 | 6.6  | 50.00  |
| T-4212   | 600        | —                          | 12       | 42 | 12 | 25/32 | 8.4  | 64.00  |
| T-4215   | 500        | —                          | 8        | 42 | 15 | 25/32 | 10.3 | 71.00  |
| T-4218   | 550        | 1                          | 8        | 42 | 18 | 25/32 | 12.1 | 78.00  |
| T-4224   | 550        | 2                          | 8        | 42 | 24 | 25/32 | 15.8 | 97.00  |
| T-4230   | 550        | 2                          | 8        | 42 | 30 | 25/32 | 19.4 | 115.00 |
| T-4809   | 550        | —                          | 16       | 48 | 9  | 25/32 | 7.5  | 67.00  |
| T-4812   | 550        | —                          | 12       | 48 | 12 | 25/32 | 9.6  | 78.00  |
| T-4815   | 450        | —                          | 8        | 48 | 15 | 25/32 | 11.7 | 88.00  |
| T-4818   | 450        | 1                          | 8        | 48 | 18 | 25/32 | 13.8 | 85.00  |
| T-4824   | 500        | 2                          | 8        | 48 | 24 | 25/32 | 17.9 | 105.00 |
| T-4830   | 500        | 2                          | 6        | 48 | 30 | 25/32 | 22.1 | 138.00 |



For use with all uprights except double wall (library) uprights. Each shelf requires two shelf supports. Load capacities are based on using the recommended number of TR-dd reinforcements and on using TS-wwgg shelf supports, with weight evenly distributed. Shelves punched for optional center dividers (CD-ww). If using SHS supports, HR-dd reinforcements are required.

\*NOTE: Load capacities do not apply to mobile units.

### Standard Colors



Sand (SND) Champagne/ Putty (CPY) Light Grey (LGY) Medium Grey (MGY) Black (BLK)

# Thin Profile Slotted Shelves & Heavy Shelves

## THIN PROFILE SLOTTED SHELVES - 22 GAUGE



**SINGLE ENTRY**



**DOUBLE ENTRY**

| CAT. NO.            | LOAD CAP.* | Recommended Reinforcements | PCS/ CTN | W  | D  | H     | WT. | PRICE   |
|---------------------|------------|----------------------------|----------|----|----|-------|-----|---------|
| <b>SINGLE ENTRY</b> |            |                            |          |    |    |       |     |         |
| TQ2-2412            | 600        | —                          | 16       | 24 | 12 | 25/32 | 3.8 | \$30.00 |
| TQ2-2415            | 500        | —                          | 8        | 24 | 15 | 25/32 | 3.8 | 36.00   |
| TQ2-3010            | 600        | —                          | 16       | 30 | 10 | 25/32 | 3.2 | 30.00   |
| TQ2-3012            | 600        | —                          | 16       | 30 | 12 | 25/32 | 3.8 | 30.00   |
| TQ2-3013            | 500        | —                          | 8        | 30 | 13 | 25/32 | 4.1 | 36.00   |
| TQ2-3015            | 500        | —                          | 8        | 30 | 15 | 25/32 | 4.7 | 36.00   |
| TQ2-3016            | 500        | 1                          | 8        | 30 | 16 | 25/32 | 4.9 | 44.00   |
| TQ2-3609            | 600        | —                          | 16       | 36 | 9  | 25/32 | 3.6 | 30.00   |
| TQ2-3610            | 600        | —                          | 16       | 36 | 10 | 25/32 | 3.9 | 30.00   |
| TQ2-3612            | 600        | —                          | 16       | 36 | 12 | 25/32 | 4.6 | 30.00   |
| TQ2-3613            | 500        | —                          | 8        | 36 | 13 | 25/32 | 4.9 | 36.00   |
| TQ2-3615            | 500        | —                          | 8        | 36 | 15 | 25/32 | 5.5 | 36.00   |
| TQ2-3616            | 500        | 1                          | 8        | 36 | 16 | 25/32 | 5.9 | 44.00   |
| TQ2-4209            | 600        | —                          | 16       | 42 | 9  | 25/32 | 4.1 | 31.00   |
| TQ2-4210            | 600        | —                          | 16       | 42 | 10 | 25/32 | 4.5 | 36.00   |
| TQ2-4212            | 600        | —                          | 12       | 42 | 12 | 25/32 | 5.3 | 36.00   |
| TQ2-4213            | 500        | —                          | 8        | 42 | 13 | 25/32 | 5.7 | 44.00   |
| TQ2-4215            | 500        | —                          | 8        | 42 | 15 | 25/32 | 6.4 | 44.00   |
| TQ2-4216            | 500        | 1                          | 12       | 42 | 16 | 25/32 | 6.8 | 57.00   |
| TQ2-4809            | 550        | —                          | 16       | 48 | 9  | 25/32 | 4.7 | 36.00   |
| TQ2-4810            | 550        | —                          | 16       | 48 | 10 | 25/32 | 5.1 | 38.00   |
| TQ2-4812            | 550        | —                          | 12       | 48 | 12 | 25/32 | 6.0 | 38.00   |
| TQ2-4813            | 400        | —                          | 8        | 48 | 13 | 25/32 | 6.4 | 47.00   |
| TQ2-4815            | 400        | —                          | 8        | 48 | 15 | 25/32 | 7.3 | 47.00   |
| TQ2-4816            | 350        | 1                          | 8        | 48 | 16 | 25/32 | 7.7 | 57.00   |

| CAT. NO.            | LOAD CAP.* | Recommended Reinforcements | PCS/ CTN | W  | D  | H     | WT.  | PRICE   |
|---------------------|------------|----------------------------|----------|----|----|-------|------|---------|
| <b>DOUBLE ENTRY</b> |            |                            |          |    |    |       |      |         |
| TQD2-2424           | 400        | 1                          | 8        | 24 | 24 | 25/32 | 5.8  | \$53.00 |
| TQD2-2430           | 400        | 2                          | 8        | 24 | 30 | 25/32 | 7.2  | 70.00   |
| TQD2-3020           | 400        | 1                          | 8        | 30 | 20 | 25/32 | 7.2  | 53.00   |
| TQD2-3024           | 400        | 1                          | 8        | 30 | 24 | 25/32 | 7.2  | 53.00   |
| TQD2-3026           | 400        | 2                          | 8        | 30 | 26 | 25/32 | 7.7  | 70.00   |
| TQD2-3030           | 400        | 2                          | 8        | 30 | 30 | 25/32 | 8.7  | 70.00   |
| TQD2-3032           | 400        | 2                          | 8        | 30 | 32 | 25/32 | 9.4  | 80.00   |
| TQD2-3618           | 500        | 1                          | 8        | 36 | 18 | 25/32 | 6.5  | 50.00   |
| TQD2-3620           | 400        | 1                          | 8        | 36 | 20 | 25/32 | 7.2  | 53.00   |
| TQD2-3624           | 400        | 1                          | 8        | 36 | 24 | 25/32 | 8.5  | 53.00   |
| TQD2-3626           | 400        | 2                          | 8        | 36 | 26 | 25/32 | 9.2  | 70.00   |
| TQD2-3630           | 400        | 2                          | 8        | 36 | 30 | 25/32 | 10.5 | 70.00   |
| TQD2-3632           | 400        | 2                          | 8        | 36 | 32 | 25/32 | 11.1 | 80.00   |
| TQD2-4218           | 500        | 1                          | 8        | 42 | 18 | 25/32 | 7.6  | 57.00   |
| TQD2-4220           | 500        | 2                          | 8        | 42 | 20 | 25/32 | 8.4  | 62.00   |
| TQD2-4224           | 500        | 2                          | 8        | 42 | 24 | 25/32 | 9.9  | 62.00   |
| TQD2-4226           | 450        | 2                          | 8        | 42 | 26 | 25/32 | 10.6 | 77.00   |
| TQD2-4230           | 450        | 2                          | 8        | 42 | 30 | 25/32 | 12.1 | 77.00   |
| TQD2-4232           | 450        | 2                          | 8        | 42 | 32 | 25/32 | 12.9 | 80.00   |
| TQD2-4818           | 350        | 1                          | 8        | 48 | 18 | 25/32 | 8.6  | 58.00   |
| TQD2-4820           | 450        | 2                          | 8        | 48 | 20 | 25/32 | 9.5  | 67.00   |
| TQD2-4824           | 450        | 2                          | 8        | 48 | 24 | 25/32 | 11.2 | 67.00   |
| TQD2-4826           | 400        | 2                          | 8        | 48 | 26 | 25/32 | 12.1 | 87.00   |
| TQD2-4830           | 400        | 2                          | 8        | 48 | 30 | 25/32 | 13.8 | 87.00   |
| TQD2-4832           | 400        | 2                          | 8        | 48 | 32 | 25/32 | 14.7 | 105.00  |

For use with all uprights except double wall (library) uprights. Each shelf requires two shelf supports. Load capacities are based on using the recommended number of TR-dd reinforcements and using TS-wvvgg shelf supports, with weight evenly distributed. If using SHS supports, HR-dd reinforcements are required. Slotted on 2" centers for optional adjustable dividers. \*NOTE: Load capacities do not apply to mobile units.



## HEAVY SHELF

Each shelf requires two shelf supports. Load capacities are based on using the recommended number of HR-dd reinforcements and using HS-ww11 shelf supports, with weight evenly distributed.

\*NOTE: Load capacities do not apply to mobile units.

| CAT. NO.           | LOAD CAP.* | Recommended Reinforcements | PCS/ CTN | W  | D  | H     | WT.  | PRICE   |
|--------------------|------------|----------------------------|----------|----|----|-------|------|---------|
| <b>HEAVY SHELF</b> |            |                            |          |    |    |       |      |         |
| H-3612             | 1,100      | —                          | 12       | 36 | 12 | 17/32 | 7.9  | \$54.00 |
| H-3615             | 1,000      | —                          | 6        | 36 | 15 | 17/32 | 9.5  | 58.00   |
| H-3618             | 950        | 1                          | 6        | 36 | 18 | 17/32 | 11.1 | 72.00   |
| H-3624             | 900        | 1                          | 6        | 36 | 24 | 17/32 | 14.4 | 89.00   |
| H-3630             | 1,000      | 2                          | 4        | 36 | 30 | 17/32 | 17.6 | 108.00  |
| H-3636             | 900        | 2                          | 4        | 36 | 36 | 17/32 | 20.8 | 126.00  |
| H-4212             | 1,000      | —                          | 8        | 42 | 12 | 17/32 | 9.1  | 78.00   |
| H-4215             | 900        | —                          | 6        | 42 | 15 | 17/32 | 11.0 | 80.00   |
| H-4218             | 800        | 1                          | 6        | 42 | 18 | 17/32 | 12.8 | 85.00   |

| CAT. NO.           | LOAD CAP.* | Recommended Reinforcements | PCS/ CTN | W  | D  | H     | WT.  | PRICE   |
|--------------------|------------|----------------------------|----------|----|----|-------|------|---------|
| <b>HEAVY SHELF</b> |            |                            |          |    |    |       |      |         |
| H-4224             | 900        | 2                          | 6        | 42 | 24 | 17/32 | 16.6 | \$98.00 |
| H-4230             | 900        | 2                          | 4        | 42 | 30 | 17/32 | 20.3 | 131.00  |
| H-4236             | 800        | 2                          | 4        | 42 | 36 | 17/32 | 24.0 | 136.00  |
| H-4812             | 900        | —                          | 8        | 48 | 12 | 17/32 | 10.3 | 75.00   |
| H-4815             | 750        | —                          | 6        | 48 | 15 | 17/32 | 12.5 | 82.00   |
| H-4818             | 700        | 1                          | 6        | 48 | 18 | 17/32 | 14.6 | 91.00   |
| H-4824             | 800        | 2                          | 6        | 48 | 24 | 17/32 | 18.8 | 112.00  |
| H-4830             | 800        | 2                          | 4        | 48 | 30 | 17/32 | 23.0 | 135.00  |
| H-4836             | 700        | 2                          | 4        | 48 | 36 | 17/32 | 27.3 | 156.00  |

### Standard Colors



## THIN SHELF SUPPORTS



| CAT. NO.        | PCS/CTN | W  | D | H   | WT. | PRICE         |
|-----------------|---------|----|---|-----|-----|---------------|
| <b>14 GAUGE</b> |         |    |   |     |     |               |
| TS-2414         | 30      | 24 | — | 3/4 | 1.0 | <b>\$9.10</b> |
| TS-3014         | 30      | 30 | — | 3/4 | 1.3 | <b>9.10</b>   |
| TS-3614         | 30      | 36 | — | 3/4 | 1.6 | <b>9.20</b>   |

| CAT. NO.        | PCS/CTN | W  | D | H   | WT. | PRICE          |
|-----------------|---------|----|---|-----|-----|----------------|
| <b>11 GAUGE</b> |         |    |   |     |     |                |
| TS-3611         | 30      | 36 | — | 3/4 | 2.5 | <b>\$14.50</b> |
| TS-4211         | 30      | 42 | — | 3/4 | 2.9 | <b>16.50</b>   |
| TS-4811         | 30      | 48 | — | 3/4 | 3.3 | <b>18.20</b>   |

## THIN SHELF REINFORCEMENTS



| CAT. NO. | PCS/CTN | W     | D  | H   | WT. | PRICE         |
|----------|---------|-------|----|-----|-----|---------------|
| TR-09    | 144     | 15/16 | 9  | 5/8 | .3  | <b>\$4.10</b> |
| TR-10    | 144     | 15/16 | 10 | 5/8 | .4  |               |
| TR-12    | 144     | 15/16 | 12 | 5/8 | .5  | <b>4.10</b>   |
| TR-13    | 144     | 15/16 | 13 | 5/8 | .5  | <b>4.70</b>   |
| TR-15    | 144     | 15/16 | 15 | 5/8 | .6  | <b>4.70</b>   |
| TR-16    | 144     | 15/16 | 16 | 5/8 | .7  | <b>5.30</b>   |

| CAT. NO. | PCS/CTN | W     | D  | H   | WT. | PRICE         |
|----------|---------|-------|----|-----|-----|---------------|
| TR-18    | 72      | 15/16 | 18 | 5/8 | .7  | <b>\$5.30</b> |
| TR-20    | 72      | 15/16 | 20 | 5/8 | 1.0 | <b>7.20</b>   |
| TR-24    | 72      | 15/16 | 24 | 5/8 | 1.0 | <b>7.20</b>   |
| TR-26    | 72      | 15/16 | 26 | 5/8 | 1.1 | <b>8.70</b>   |
| TR-30    | 72      | 15/16 | 30 | 5/8 | 1.3 | <b>8.70</b>   |
| TR-32    | 72      | 15/16 | 32 | 5/8 | 1.3 | <b>8.70</b>   |

## THIN SHELF SUPPORTS (For Single Entry Only)

An economical option for use with single-entry units only. TSC-ww14 shelf supports will not accept shelf reinforcements, and thus should not be used when TR-dd shelf reinforcements are required. Two supports required per shelf.



| CAT. NO.        | PCS/CTN | W  | D | H   | WT. | PRICE          |
|-----------------|---------|----|---|-----|-----|----------------|
| <b>14 GAUGE</b> |         |    |   |     |     |                |
| TSC-3614        | 30      | 36 | — | 3/4 | 1.5 | <b>\$10.40</b> |
| TSC-4214        | 30      | 42 | — | 3/4 | 1.9 | <b>11.80</b>   |
| TSC-4814        | 30      | 48 | — | 3/4 | 2.2 | <b>13.80</b>   |

## HEAVY SHELF SUPPORTS



| CAT. NO.        | PCS/CTN | W  | D | H     | WT. | PRICE         |
|-----------------|---------|----|---|-------|-----|---------------|
| <b>14 GAUGE</b> |         |    |   |       |     |               |
| HS-3014         | 30      | 30 | — | 1 1/8 | 1.3 | <b>\$9.80</b> |
| HS-3614         | 30      | 36 | — | 1 1/8 | 1.8 | <b>9.80</b>   |
| HS-4214         | 30      | 42 | — | 1 1/8 | 2.0 | <b>11.50</b>  |
| HS-4814         | 30      | 48 | — | 1 1/8 | 2.2 | <b>12.80</b>  |

| CAT. NO.        | PCS/CTN | W  | D | H     | WT. | PRICE          |
|-----------------|---------|----|---|-------|-----|----------------|
| <b>11 GAUGE</b> |         |    |   |       |     |                |
| HS-3611         | 30      | 36 | — | 1 1/8 | 2.6 | <b>\$16.20</b> |
| HS-4211         | 30      | 42 | — | 1 1/8 | 3.1 | <b>17.00</b>   |
| HS-4811         | 30      | 48 | — | 1 1/8 | 3.6 | <b>18.90</b>   |

## HEAVY SHELF REINFORCEMENTS



| CAT. NO. | PCS/CTN | W     | D  | H   | WT. | PRICE         |
|----------|---------|-------|----|-----|-----|---------------|
| HR-12    | 96      | 15/16 | 12 | 5/8 | .7  | <b>\$5.70</b> |
| HR-13    | 96      | 15/16 | 13 | 5/8 | .8  | <b>6.40</b>   |
| HR-15    | 96      | 15/16 | 15 | 5/8 | .9  | <b>6.40</b>   |
| HR-16    | 96      | 15/16 | 16 | 5/8 | 1.1 | <b>7.20</b>   |
| HR-18    | 48      | 15/16 | 18 | 5/8 | 1.1 | <b>7.20</b>   |

| CAT. NO. | PCS/CTN | W     | D  | H   | WT. | PRICE         |
|----------|---------|-------|----|-----|-----|---------------|
| HR-20    | 48      | 15/16 | 20 | 5/8 | 1.5 | <b>\$9.50</b> |
| HR-24    | 48      | 15/16 | 24 | 5/8 | 1.5 | <b>9.50</b>   |
| HR-26    | 48      | 15/16 | 26 | 5/8 | 1.6 | <b>11.20</b>  |
| HR-30    | 48      | 15/16 | 30 | 5/8 | 1.9 | <b>11.20</b>  |
| HR-32    | 48      | 15/16 | 32 | 5/8 | 2.3 | <b>13.60</b>  |
| HR-36    | 36      | 15/16 | 36 | 5/8 | 2.3 | <b>13.60</b>  |

## SINGLE RIVET BOTTOM SHELF SUPPORTS



Two supports required per shelf. Use HR-dd reinforcements for 18" & deeper shelves. Use only with bottom shelf, to permit shelf to fit flush with floor or for attachment to mobile bases.

| CAT. NO. | PCS/CTN | W  | D | H     | WT. | PRICE          |
|----------|---------|----|---|-------|-----|----------------|
| SHS-2414 | 30      | 24 | — | 1 3/8 | 2.0 | <b>\$13.80</b> |
| SHS-3014 | 30      | 30 | — | 1 3/8 | 2.0 | <b>13.80</b>   |
| SHS-3614 | 30      | 36 | — | 1 3/8 | 2.0 | <b>13.80</b>   |
| SHS-4214 | 30      | 42 | — | 1 3/8 | 2.4 | <b>14.30</b>   |
| SHS-4814 | 30      | 48 | — | 1 3/8 | 2.7 | <b>15.80</b>   |

## HANG-ROD COMPONENTS

Hang rod assemblies require two hanging brackets, one hang bar and four galvanized clips (each sold separately, below) to attach. Provides one hanging position.



| CAT. NO.              | PCS/CTN | W       | D   | H     | WT. | PRICE          |
|-----------------------|---------|---------|-----|-------|-----|----------------|
| <b>HANG BAR</b>       |         |         |     |       |     |                |
| LTTB-30               | 1       | 30      | 1/2 | 1 1/2 | 2.1 | <b>\$26.00</b> |
| LTTB-36               | 1       | 36      | 1/2 | 1 1/2 | 2.1 | <b>27.00</b>   |
| LTTB-42               | 1       | 42      | 1/2 | 1 1/2 | 2.4 | <b>30.00</b>   |
| LTTB-48               | 1       | 48      | 1/2 | 1 1/2 | 2.7 | <b>33.00</b>   |
| <b>HANG BAR CLIPS</b> |         |         |     |       |     |                |
| MC-1P                 | 1       | Painted |     |       | .1  | <b>\$0.94</b>  |

| CAT. NO.                | PCS/CTN | W | D  | H     | WT. | PRICE          |
|-------------------------|---------|---|----|-------|-----|----------------|
| <b>HANGING BRACKETS</b> |         |   |    |       |     |                |
| HRSB-12                 | 1       | 1 | 12 | 2 1/8 | 1.2 | <b>\$27.00</b> |
| HRSB-15                 | 1       | 1 | 15 | 2 1/8 | 1.5 | <b>28.00</b>   |
| HRSB-18                 | 1       | 1 | 18 | 2 1/8 | 1.9 | <b>22.00</b>   |
| HRSB-24                 | 1       | 1 | 24 | 2 1/8 | 2.5 | <b>24.00</b>   |
| HRSB-30                 | 1       | 1 | 30 | 2 1/8 | 3.2 | <b>34.00</b>   |

### Standard Colors



# Alt Shelves, Backs, Stops, Dividers, Nylon Feet

## PERIODICAL SHELVES

| CAT. NO. | PCS/CTN | W  | D  | H                              | WT.  | PRICE         |
|----------|---------|----|----|--------------------------------|------|---------------|
| LTPD-30  | 8       | 30 | 14 | 1 <sup>5</sup> / <sub>16</sub> | 8.7  |               |
| LTPD-36  | 8       | 36 | 14 | 1 <sup>5</sup> / <sub>16</sub> | 10.1 | <b>193.00</b> |
| LTPD-42  | 8       | 42 | 14 | 1 <sup>5</sup> / <sub>16</sub> | 11.7 |               |
| LTPD-48  | 8       | 48 | 14 | 1 <sup>5</sup> / <sub>16</sub> | 13.2 | <b>220.00</b> |

Used for displaying media such as magazines, journals, etc.



For quantities less than 25 pieces, add \$300/Net setup charge.

## BACKS - TWO PIECES

| CAT. NO.        | W  | D | H                                | WT.  | PRICE           |
|-----------------|----|---|----------------------------------|------|-----------------|
| <b>30" WIDE</b> |    |   |                                  |      |                 |
| LTBP-3064-2     | 30 | — | 64 <sup>3</sup> / <sub>16</sub>  | 13.0 | <b>\$236.00</b> |
| LTBP-3076-2     | 30 | — | 76 <sup>3</sup> / <sub>16</sub>  | 15.4 | <b>227.00</b>   |
| LTBP-3085-2     | 30 | — | 85 <sup>3</sup> / <sub>16</sub>  | 17.2 | <b>267.00</b>   |
| LTBP-3088-2     | 30 | — | 88 <sup>3</sup> / <sub>16</sub>  | 17.8 | <b>251.00</b>   |
| LTBP-3097-2     | 30 | — | 97 <sup>3</sup> / <sub>16</sub>  | 19.9 | <b>304.00</b>   |
| LTBP-30121-2    | 30 | — | 121 <sup>3</sup> / <sub>16</sub> | 25.0 | <b>351.00</b>   |
| <b>36" WIDE</b> |    |   |                                  |      |                 |
| LTBP-3664-2     | 36 | — | 64 <sup>3</sup> / <sub>16</sub>  | 15.6 | <b>\$236.00</b> |
| LTBP-3676-2     | 36 | — | 76 <sup>3</sup> / <sub>16</sub>  | 18.6 | <b>227.00</b>   |
| LTBP-3685-2     | 36 | — | 85 <sup>3</sup> / <sub>16</sub>  | 21.0 | <b>267.00</b>   |
| LTBP-3688-2     | 36 | — | 88 <sup>3</sup> / <sub>16</sub>  | 21.0 | <b>251.00</b>   |
| LTBP-3697-2     | 36 | — | 97 <sup>3</sup> / <sub>16</sub>  | 24.0 | <b>304.00</b>   |
| LTBP-36121-2    | 36 | — | 121 <sup>3</sup> / <sub>16</sub> | 30.0 | <b>351.00</b>   |

| CAT. NO.        | W  | D | H                                | WT.  | PRICE           |
|-----------------|----|---|----------------------------------|------|-----------------|
| <b>42" WIDE</b> |    |   |                                  |      |                 |
| LTBP-4264-2     | 42 | — | 64 <sup>3</sup> / <sub>16</sub>  | 18.3 | <b>\$260.00</b> |
| LTBP-4276-2     | 42 | — | 76 <sup>3</sup> / <sub>16</sub>  | 22.0 | <b>271.00</b>   |
| LTBP-4285-2     | 42 | — | 85 <sup>3</sup> / <sub>16</sub>  | 24.0 | <b>307.00</b>   |
| LTBP-4288-2     | 42 | — | 88 <sup>3</sup> / <sub>16</sub>  | 25.0 | <b>293.00</b>   |
| LTBP-4297-2     | 42 | — | 97 <sup>3</sup> / <sub>16</sub>  | 28.0 | <b>332.00</b>   |
| LTBP-42121-2    | 42 | — | 121 <sup>3</sup> / <sub>16</sub> | 35.0 | <b>358.00</b>   |
| <b>48" WIDE</b> |    |   |                                  |      |                 |
| LTBP-4864-2     | 48 | — | 64 <sup>3</sup> / <sub>16</sub>  | 21.0 | <b>\$261.00</b> |
| LTBP-4876-2     | 48 | — | 76 <sup>3</sup> / <sub>16</sub>  | 25.0 | <b>291.00</b>   |
| LTBP-4885-2     | 48 | — | 85 <sup>3</sup> / <sub>16</sub>  | 28.0 | <b>311.00</b>   |
| LTBP-4888-2     | 48 | — | 88 <sup>3</sup> / <sub>16</sub>  | 29.0 | <b>322.00</b>   |
| LTBP-4897-2     | 48 | — | 97 <sup>3</sup> / <sub>16</sub>  | 32.0 | <b>349.00</b>   |
| LTBP-48121-2    | 48 | — | 121 <sup>3</sup> / <sub>16</sub> | 40.0 | <b>400.00</b>   |

Packed 4 pieces per carton. Top and bottom stiffeners included.



## SLOTTED AND ADJUSTABLE BACK STOPS

| CAT. NO.                  | PCS/CTN | W  | D | H | WT. | PRICE          |
|---------------------------|---------|----|---|---|-----|----------------|
| <b>SLOTTED BACK STOPS</b> |         |    |   |   |     |                |
| BS-30                     | 40      | 30 | — | 2 | 1.2 | <b>\$10.20</b> |
| BS-36                     | 40      | 36 | — | 2 | 1.3 | <b>10.20</b>   |
| BS-42                     | 40      | 42 | — | 2 | 1.6 | <b>11.60</b>   |
| BS-48                     | 40      | 48 | — | 2 | 1.8 | <b>12.80</b>   |

**SLOTTED BACK STOPS**  
Use with FD-0808, FD-1108, FDP-1108, FD-1612, PD-1108



| CAT. NO.                    | PCS/CTN | W  | D | H | WT. | PRICE          |
|-----------------------------|---------|----|---|---|-----|----------------|
| <b>SLOTTED CENTER STOP*</b> |         |    |   |   |     |                |
| CS-30                       | 20      | 30 | — | 4 | 1.9 | <b>\$13.80</b> |
| CS-36                       | 20      | 36 | — | 4 | 2.2 | <b>13.80</b>   |
| CS-42                       | 20      | 42 | — | 4 | 2.6 | <b>16.00</b>   |
| CS-48                       | 20      | 48 | — | 4 | 3.0 | <b>17.90</b>   |

Use with double entry thin slotted shelves only.

## SLOTTED CENTER STOPS



| CAT. NO.                         | PCS/CTN | W  | D                           | H | WT. | PRICE          |
|----------------------------------|---------|----|-----------------------------|---|-----|----------------|
| <b>UNSLOTTED CENTER DIVIDERS</b> |         |    |                             |   |     |                |
| CD-30                            | 50      | 30 | <sup>3</sup> / <sub>8</sub> | 2 | 1.4 | <b>\$20.00</b> |
| CD-36                            | 50      | 36 | <sup>3</sup> / <sub>8</sub> | 2 | 1.4 | <b>20.00</b>   |
| CD-42                            | 50      | 42 | <sup>3</sup> / <sub>8</sub> | 2 | 1.6 | <b>22.00</b>   |
| CD-48                            | 50      | 48 | <sup>3</sup> / <sub>8</sub> | 2 | 1.8 | <b>23.00</b>   |

Use with unslotted shelves to divide shelves into equal halves. Not available for use on 9" deep shelves.



## UNSLOTTED CENTER DIVIDERS

| CAT. NO.                               | PCS/CTN | W | D  | H | WT. | PRICE         |
|--|---------|---|----|---|-----|---------------|
| <b>ADJUSTABLE FILE DIVIDER (STEEL)</b> |         |   |    |   |     |               |
| FD-0808*                               | 40      | — | 8  | 8 | .5  | <b>\$5.50</b> |
| FD-1108**                              | 50      | — | 11 | 8 | .8  | <b>5.00</b>   |
| FDP-1108                               | 50      | — | 11 | 8 | .8  | <b>5.00</b>   |

\*Use FD-0808 with TQ2-ww09, LQ2-ww09 & LQD2-ww18.  
\*\*Includes Tennsco imprint.



FD-1108

## ADJUSTABLE DIVIDERS

| CAT. NO. | DESCRIPTION       | PRICE         |
|----------|-------------------|---------------|
| LTNF-L   | Fits "L" Uprights | <b>\$2.60</b> |
| LTNF-T   | Fits "T" Uprights | <b>2.60</b>   |

Black nylon foot shaped to fit each type of L&T upright. May also be used as an upright top cap. Two required per upright.



Available in Black only.

Foot For "T" Uprights

Foot For "L" Uprights

### Standard Colors (Unless Otherwise Specified)

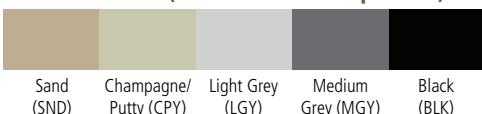

SHELVING

# Miscellaneous Parts

## REFERENCE SHELF KITS



Shelf is 11<sup>7</sup>/<sub>8</sub>" deep. Reduces filing space by 1". Kit comes with mounting brackets and one shelf. Brackets and shelves packed separately. For double entry units, order extra shelf.

| CAT. NO.                                      | PCS/CTN | W  | D                              | H   | WT.  | PRICE   |
|---|---------|----|--------------------------------|-----|------|---------|
| Used on 36", 42" or 48" wide units            |         |    |                                |     |      |         |
| RSMB-12                                       | 2       | 30 | 12                             | 5/8 | 9.3  | \$98.00 |
| RSMB-15                                       | 2       | 30 | 15                             | 5/8 | 9.7  | 100.00  |
| RSMB-18                                       | 2       | 30 | 18                             | 5/8 | 10.0 | 105.00  |
| RSMB-24                                       | 2       | 30 | 24                             | 5/8 | 10.8 | 108.00  |
| RSMB-30                                       | 2       | 30 | 30                             | 5/8 | 11.6 | 112.00  |
| RSMB-36                                       | 2       | 30 | 36                             | 5/8 | 12.4 | 114.00  |
| 30" WIDE EXTRA SHELF (FOR DOUBLE ENTRY UNITS) |         |    |                                |     |      |         |
| RS-3012                                       | 2       | 30 | 11 <sup>7</sup> / <sub>8</sub> | 5/8 | 7.2  | \$81.00 |

| CAT. NO.                                      | PCS/CTN | W  | D                              | H   | WT.  | PRICE    |
|---|---------|----|--------------------------------|-----|------|----------|
| Used on 30" wide units                        |         |    |                                |     |      |          |
| RSMB-12-24                                    | 2       | 24 | 12                             | 5/8 | 7.9  | \$139.00 |
| RSMB-15-24                                    | 2       | 24 | 15                             | 5/8 | 8.3  | 141.00   |
| RSMB-18-24                                    | 2       | 24 | 18                             | 5/8 | 8.6  | 146.00   |
| RSMB-24-24                                    | 2       | 24 | 24                             | 5/8 | 9.4  | 149.00   |
| RSMB-30-24                                    | 2       | 24 | 30                             | 5/8 | 10.2 | 153.00   |
| RSMB-36-24                                    | 2       | 24 | 36                             | 5/8 | 11.0 |          |
| 24" WIDE EXTRA SHELF (FOR DOUBLE ENTRY UNITS) |         |    |                                |     |      |          |
| RS-2412                                       | 2       | 24 | 11 <sup>7</sup> / <sub>8</sub> | 5/8 | 5.8  | \$122.00 |

## FRONT BASES



Acts as a kickplate and provides a flush, finished appearance.

| CAT. NO. | PCS/CTN | W  | D | H                              | WT. | PRICE  |
|----------|---------|----|---|--------------------------------|-----|--------|
| FB-3002  | 50      | 30 | — | 2 <sup>5</sup> / <sub>16</sub> | .7  | \$8.40 |
| FB-3602  | 50      | 36 | — | 2 <sup>5</sup> / <sub>16</sub> | 1.0 | 8.40   |
| FB-4202  | 50      | 42 | — | 2 <sup>5</sup> / <sub>16</sub> | 1.1 | 13.70  |
| FB-4802  | 50      | 48 | — | 2 <sup>5</sup> / <sub>16</sub> | 1.3 | 10.90  |

| CAT. NO. | PCS/CTN | W  | D | H                              | WT. | PRICE   |
|----------|---------|----|---|--------------------------------|-----|---------|
| FB-3004  | 50      | 30 | — | 3 <sup>5</sup> / <sub>16</sub> | 1.1 | \$11.90 |
| FB-3604  | 50      | 36 | — | 3 <sup>5</sup> / <sub>16</sub> | 1.6 | 11.90   |
| FB-4204  | 50      | 42 | — | 3 <sup>5</sup> / <sub>16</sub> | 1.8 | 16.50   |
| FB-4804  | 50      | 48 | — | 3 <sup>5</sup> / <sub>16</sub> | 2.0 | 18.30   |

## AISLE TIES



Use to tie units together across aisle for extra stabilization in tall units. Other lengths available upon request; consult factory for pricing.

| CAT. NO. | PCS/CTN | W  | D | H                             | WT. | PRICE   |
|----------|---------|----|---|-------------------------------|-----|---------|
| LTAT-36  | 10      | 36 | — | 2 <sup>3</sup> / <sub>4</sub> | 3.0 | \$41.00 |
| LTAT-42  | 10      | 42 | — | 2 <sup>3</sup> / <sub>4</sub> | 3.4 | 44.00   |
| LTAT-48  | 10      | 48 | — | 2 <sup>3</sup> / <sub>4</sub> | 3.9 | 47.00   |

## BOOK SUPPORTS



Non-skid base included; packed as ordered.

| CAT. NO. | W                             | D                             | H | WT. | PRICE   |
|----------|-------------------------------|-------------------------------|---|-----|---------|
| BSN6     | 4 <sup>5</sup> / <sub>8</sub> | 1 <sup>3</sup> / <sub>4</sub> | 6 | .6  | \$11.50 |
| BSN9     | 4 <sup>5</sup> / <sub>8</sub> | 1 <sup>3</sup> / <sub>4</sub> | 9 | 1.1 | 14.00   |

## MISCELLANEOUS L&T PARTS



| CAT. NO. | DESCRIPTION                                    | PRICE  |
|----------|--|--------|
| LTCP-1   | Ties posts back-to-back                        | \$3.30 |
| LTWT-1   | Attaches post to wall for added security       | 3.40   |
| LTSP-1   | Prevents shelf support from slipping           | 0.77   |
| LTSI-36  | Provides extra stability for seismic standards | 15.30  |
| LTUP-1   | To touch up scrapes and scratches              | 19.80  |
| LTSPL-1  | Splice for extending existing posts            | 4.80   |
| SCH-P    | Holds 3x5" cards for shelf labeling            | 6.00   |

Color options only available on select products.

## LEVELING FEET



Color options not available

| CAT. NO.                                       | DESCRIPTION       | SIZE             | PRICE  |
|--|-------------------|------------------|--------|
| SMALL LEVELER (FOR USE ON CONCRETE/TILE FLOOR) |                   |                  |        |
| LPLI-S   | Fits "L" Uprights | 1/4"-20 x 9/16"  | \$2.80 |
| TPLI-S   | Fits "T" Uprights | 1/4"-20 x 9/16"  | 2.10   |
| LARGE LEVELER (FOR USE ON CARPET)              |                   |                  |        |
| LPLI-L   | Fits "L" Uprights | 1/4"-20 x 1 3/8" | \$4.80 |
| TPLI-L   | Fits "T" Uprights | 1/4"-20 x 1 3/8" | 2.60   |

### Standard Colors (Unless Otherwise Specified)





# Flared & Adjustable Leg Workbenches

## FLARED LEG WORKBENCHES



Steel Top with Flared Legs



Plastic Top with Flared Legs



Hardwood Top with Flared Legs



Compressed Top with Flared Legs

National Motor Freight Class: 70

| CAT. NO.                   | LOAD CAP. | W  | D  | H      | WT. | PRICE    |
|----------------------------|-----------|----|----|--------|-----|----------|
| <b>Steel Top</b>           |           |    |    |        |     |          |
| WB-1-3048S♣                | 4,000     | 48 | 30 | 33 1/2 | 91  | \$550.00 |
| WB-1-3060S♣                | 2,500     | 60 | 30 | 33 1/2 | 103 | 589.00   |
| WB-1-3072S♣                | 1,800     | 72 | 30 | 33 1/2 | 120 | 645.00   |
| WB-1-3096S*♣               | 4,000     | 96 | 30 | 33 1/2 | 173 | 896.00   |
| WB-1-3660S♣                | 2,500     | 60 | 36 | 33 1/2 | 122 | 666.00   |
| WB-1-3672S♣                | 1,800     | 72 | 36 | 33 1/2 | 134 | 725.00   |
| WB-1-3696S*♣               | 4,000     | 96 | 36 | 33 1/2 | 192 | 984.00   |
| <b>Plastic Top</b>         |           |    |    |        |     |          |
| WB-1-3048P♣                | 1,200     | 48 | 30 | 33 1/2 | 126 | \$754.00 |
| WB-1-3060P♣                | 800       | 60 | 30 | 33 1/2 | 123 | 785.00   |
| WB-1-3072P♣                | 750       | 72 | 30 | 33 1/2 | 139 | 893.00   |
| WB-1-3096P*♣               | 1,200     | 96 | 30 | 33 1/2 | 190 | 1,258.00 |
| WB-1-3660P♣                | 800       | 60 | 36 | 33 1/2 | 150 | 996.00   |
| WB-1-3672P♣                | 750       | 72 | 36 | 33 1/2 | 182 | 1,037.00 |
| WB-1-3696P*♣               | 1,200     | 96 | 36 | 33 1/2 | 225 | 1,426.00 |
| <b>Hardwood Top</b>        |           |    |    |        |     |          |
| WB-1-3048W♣                | 4,000     | 48 | 30 | 33 3/4 | 96  | \$957.00 |
| WB-1-3060W♣                | 3,800     | 60 | 30 | 33 3/4 | 124 | 1,070.00 |
| WB-1-3072W♣                | 3,600     | 72 | 30 | 33 3/4 | 142 | 1,237.00 |
| WB-1-3096W*♣               | 4,000     | 96 | 30 | 33 3/4 | 184 | 1,708.00 |
| WB-1-3660W♣                | 3,800     | 60 | 36 | 33 3/4 | 137 | 1,240.00 |
| WB-1-3672W♣                | 3,600     | 72 | 36 | 33 3/4 | 162 | 1,423.00 |
| WB-1-3696W*♣               | 4,000     | 96 | 36 | 33 3/4 | 217 | 2,438.00 |
| <b>Compressed Wood Top</b> |           |    |    |        |     |          |
| WB-1-3048C♣                | 2,400     | 48 | 30 | 33 3/4 | 124 | \$746.00 |
| WB-1-3060C♣                | 1,900     | 60 | 30 | 33 3/4 | 152 | 816.00   |
| WB-1-3072C♣                | 1,500     | 72 | 30 | 33 3/4 | 175 | 919.00   |
| WB-1-3096C*♣               | 2,400     | 96 | 30 | 33 3/4 | 233 | 1,454.00 |
| WB-1-3660C♣                | 1,900     | 60 | 36 | 33 3/4 | 169 | 945.00   |
| WB-1-3672C♣                | 1,500     | 72 | 36 | 33 3/4 | 206 | 1,071.00 |
| WB-1-3696C*♣               | 2,400     | 96 | 36 | 33 3/4 | 270 | 1,500.00 |

\*96" w workbenches have 3 sets of legs.

- Assembly required.

## ADJUSTABLE LEG WORKBENCHES



Steel Top with Adjustable Legs



Plastic Top with Adjustable Legs



Hardwood Top with Adjustable Legs



Compressed Top with Adjustable Legs

National Motor Freight Class: 70

| CAT. NO.                   | LOAD CAP. | W  | D  | H             | WT. | PRICE    |
|----------------------------|-----------|----|----|---------------|-----|----------|
| <b>Steel Top</b>           |           |    |    |               |     |          |
| WBA-1-3048S♣               | 4,000     | 48 | 30 | 29 3/8-36 7/8 | 98  | \$564.00 |
| WBA-1-3060S♣               | 2,500     | 60 | 30 | 29 3/8-36 7/8 | 110 | 603.00   |
| WBA-1-3072S♣               | 1,800     | 72 | 30 | 29 3/8-36 7/8 | 127 | 659.00   |
| WBA-1-3096S*♣              | 4,000     | 96 | 30 | 29 3/8-36 7/8 | 182 | 917.00   |
| WBA-1-3660S♣               | 2,500     | 60 | 36 | 29 3/8-36 7/8 | 129 | 684.00   |
| WBA-1-3672S♣               | 1,800     | 72 | 36 | 29 3/8-36 7/8 | 141 | 743.00   |
| WBA-1-3696S*♣              | 4,000     | 96 | 36 | 29 3/8-36 7/8 | 202 | 1,011.00 |
| <b>Plastic Top</b>         |           |    |    |               |     |          |
| WBA-1-3048P♣               | 1,200     | 48 | 30 | 29 3/8-36 7/8 | 115 | \$768.00 |
| WBA-1-3060P♣               | 800       | 60 | 30 | 29 3/8-36 7/8 | 130 | 799.00   |
| WBA-1-3072P♣               | 750       | 72 | 30 | 29 3/8-36 7/8 | 145 | 907.00   |
| WBA-1-3096P*♣              | 1,200     | 96 | 30 | 29 3/8-36 7/8 | 200 | 1,279.00 |
| WBA-1-3660P♣               | 800       | 60 | 36 | 29 3/8-36 7/8 | 157 | 1,014.00 |
| WBA-1-3672P♣               | 750       | 72 | 36 | 29 3/8-36 7/8 | 188 | 1,055.00 |
| WBA-1-3696P*♣              | 1,200     | 96 | 36 | 29 3/8-36 7/8 | 235 | 1,453.00 |
| <b>Hardwood Top</b>        |           |    |    |               |     |          |
| WBA-1-3048W♣               | 4,000     | 48 | 30 | 29 5/8-37 1/8 | 103 | \$971.00 |
| WBA-1-3060W♣               | 3,800     | 60 | 30 | 29 5/8-37 1/8 | 131 | 1,084.00 |
| WBA-1-3072W♣               | 3,600     | 72 | 30 | 29 5/8-37 1/8 | 148 | 1,251.00 |
| WBA-1-3096W*♣              | 4,000     | 96 | 30 | 29 5/8-37 1/8 | 194 | 1,729.00 |
| WBA-1-3660W♣               | 3,800     | 60 | 36 | 29 5/8-37 1/8 | 144 | 1,258.00 |
| WBA-1-3672W♣               | 3,600     | 72 | 36 | 29 5/8-37 1/8 | 168 | 1,441.00 |
| WBA-1-3696W*♣              | 4,000     | 96 | 36 | 29 5/8-37 1/8 | 227 | 2,465.00 |
| <b>Compressed Wood Top</b> |           |    |    |               |     |          |
| WBA-1-3048C♣               | 2,400     | 48 | 30 | 29 5/8-37 1/8 | 131 | \$760.00 |
| WBA-1-3060C♣               | 1,900     | 60 | 30 | 29 5/8-37 1/8 | 159 | 830.00   |
| WBA-1-3072C♣               | 1,500     | 72 | 30 | 29 5/8-37 1/8 | 181 | 933.00   |
| WBA-1-3096C*♣              | 2,400     | 96 | 30 | 29 5/8-37 1/8 | 238 | 1,475.00 |
| WBA-1-3660C♣               | 1,900     | 60 | 36 | 29 5/8-37 1/8 | 176 | 963.00   |
| WBA-1-3672C♣               | 1,500     | 72 | 36 | 29 5/8-37 1/8 | 212 | 1,089.00 |
| WBA-1-3696C*♣              | 2,400     | 96 | 36 | 29 5/8-37 1/8 | 280 | 1,527.00 |

\*96" w workbenches have 3 sets of legs.

- Assembly required.

### Standard Colors



Items with this symbol are available to ship in 2-3 days. Limited quantities and select colors.



(MGY)

# Electronic Workbenches

## ELECTRONIC WORKBENCHES



EB-1-3072S  
Solid Steel Top  
Electronic Workbench



EB-2-3072M  
Hard Wood Top  
Electronic Workbench  
With Electronic Riser

- Assembly required.

| CAT. NO.   | TOP MATERIAL     | W  | D  | H      | LOAD CAP.* | WT. | PRICE             |
|--|------------------|----|----|--------|------------|-----|-------------------|
| <b>Electronic Workbench with Stringer and Outlet Panel</b>                   |                  |    |    |        |            |     |                   |
| EB-1-3072S♣  | Solid Steel      | 72 | 30 | 33 1/2 | 1,800      | 156 | <b>\$926.00</b>   |
| EB-1-3072M♣  | Hard Wood        | 72 | 30 | 33 3/4 | 2,000      | 178 | <b>1,518.00</b>   |
| EB-1-3672M♣  | Hard Wood        | 72 | 36 | 33 3/4 | 2,000      | 195 | <b>1,694.00</b>   |
| EB-1-3072P♣  | Plastic Laminate | 72 | 30 | 33 1/2 | 750        | 175 | <b>1,174.00</b>   |
| EB-1-3672P♣  | Plastic Laminate | 72 | 36 | 33 1/2 | 750        | 215 | <b>1,308.00</b>   |
| EB-1-3072C♣  | Compressed Wood  | 72 | 30 | 33 3/4 | 1,500      | 211 | <b>1,200.00</b>   |
| EB-1-3672C♣  | Compressed Wood  | 72 | 36 | 33 3/4 | 1,500      | 239 | <b>1,342.00</b>   |
| <b>Electronic Workbench with Stringer, Outlet Panel and Electronic Riser</b> |                  |    |    |        |            |     |                   |
| EB-2-3072S♣  | Solid Steel      | 72 | 30 | 33 1/2 | 1,800      | 187 | <b>\$1,121.00</b> |
| EB-2-3072M♣  | Hard Wood        | 72 | 30 | 33 3/4 | 2,000      | 209 | <b>1,713.00</b>   |
| EB-2-3672M♣  | Hard Wood        | 72 | 36 | 33 3/4 | 2,000      | 226 | <b>1,889.00</b>   |
| EB-2-3072P♣  | Plastic Laminate | 72 | 30 | 33 1/2 | 750        | 206 | <b>1,369.00</b>   |
| EB-2-3672P♣  | Plastic Laminate | 72 | 36 | 33 1/2 | 750        | 246 | <b>1,503.00</b>   |
| EB-2-3072C♣  | Compressed Wood  | 72 | 30 | 33 3/4 | 1,500      | 242 | <b>1,395.00</b>   |
| EB-2-3672C♣  | Compressed Wood  | 72 | 36 | 33 3/4 | 1,500      | 270 | <b>1,537.00</b>   |

\*Load capacity is for top only. This is not the represented load capacity for riser.  
Includes top, panel legs and electronic outlet panel. Electronic wiring kit is not included with outlet panel.  
Wiring kit (WK-1) must be ordered separately, found on page 73.

National Motor Freight Class: 70

## ELECTRONIC MODULAR WORKBENCHES



EMB-1-3072S  
Solid Steel Top  
Electronic Modular  
Workbench



EMB-2-3072M  
Hard Wood Top  
Electronic Modular  
Workbench

- Assembly required.

| CAT. NO.       | TOP MATERIAL                           | W  | D  | H      | LOAD CAP. | WT. | PRICE             |
|----------------|--|----|----|--------|-----------|-----|-------------------|
| EMB-1-3072S*♣  | Solid Steel w/ 2 Drawer Units          | 72 | 30 | 33 1/2 | 1,800     | 248 | <b>\$2,264.00</b> |
| EMB-1-3072M*♣  | Hard Wood w/ 2 Drawer Units            | 72 | 30 | 33 3/4 | 2,000     | 267 | <b>2,837.00</b>   |
| EMB-1-3072P*♣  | Plastic Laminate w/ 2 Drawer Units     | 72 | 30 | 33 1/2 | 750       | 264 | <b>2,493.00</b>   |
| EMB-1-3072C*♣  | Compressed Wood w/ 2 Drawer Units      | 72 | 30 | 33 3/4 | 1,500     | 300 | <b>2,519.00</b>   |
| EMB-2-3072S**♣ | Solid Steel w/ 1 Drawer & Cabinet      | 72 | 30 | 33 1/2 | 1,800     | 219 | <b>1,859.00</b>   |
| EMB-2-3072M*♣  | Hard Wood w/ 1 Drawer & Cabinet        | 72 | 30 | 33 3/4 | 2,000     | 238 | <b>2,432.00</b>   |
| EMB-2-3072P**♣ | Plastic Laminate w/ 1 Drawer & Cabinet | 72 | 30 | 33 1/2 | 750       | 235 | <b>2,088.00</b>   |
| EMB-2-3072C**♣ | Compressed Wood w/ 1 Drawer & Cabinet  | 72 | 30 | 33 3/4 | 1,500     | 271 | <b>2,114.00</b>   |

Load capacity is for top only.

\* Includes top, two modular drawer units and electric outlet panel. Electric wiring kit is not included with outlet panel.

\*\* Includes top, one modular drawer unit, one modular cabinet unit and electric outlet panel. Electric wiring kit is not included with outlet panel.  
Wiring kit (WK-1) must be ordered separately, found on page 73.

National Motor Freight Class: 70

### Standard Colors

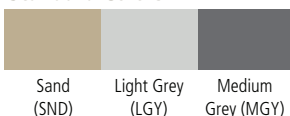

♣ Items with these symbols are available to ship in 2-3 days. Limited quantities and select colors.



# Workbench Tops

## STEEL TOPS



\*96" w tops require three legs.  
Durable 12 gauge steel work surface reinforced with 14 gauge mounting brackets. Includes two mounting brackets (enough to mount one workbench drawer or two modular cabinets).

Stringer required for workbenches with legs & no pedestals.

National Motor Freight Class: 70

| CAT. NO.                | LOAD CAP. | W  | D  | H     | WT. | PRICE    |
|-------------------------|-----------|----|----|-------|-----|----------|
| <b>With Stringer</b>    |           |    |    |       |     |          |
| T-3048 ♣                | 4,000     | 48 | 30 | 1 1/2 | 62  | \$370.00 |
| T-3060 ♣                | 2,500     | 60 | 30 | 1 1/2 | 74  | 409.00   |
| T-3072 ♣                | 1,800     | 72 | 30 | 1 1/2 | 91  | 465.00   |
| T-3096* ♣               | 4,000     | 96 | 30 | 1 1/2 | 129 | 626.00   |
| T-3648 ♣                | 4,000     | 48 | 36 | 1 1/2 | 71  | 402.00   |
| T-3660 ♣                | 2,500     | 60 | 36 | 1 1/2 | 90  | 476.00   |
| T-3672 ♣                | 1,800     | 72 | 36 | 1 1/2 | 107 | 535.00   |
| T-3696* ♣               | 4,000     | 96 | 36 | 1 1/2 | 144 | 699.00   |
| <b>Without Stringer</b> |           |    |    |       |     |          |
| G-T-3048                | 4,000     | 48 | 30 | 1 1/2 | 57  | \$350.00 |
| G-T-3060 ♣              | 2,500     | 60 | 30 | 1 1/2 | 69  | 379.00   |
| G-T-3072 ♣              | 1,800     | 72 | 30 | 1 1/2 | 84  | 435.00   |
| G-T-3096*               | 4,000     | 96 | 30 | 1 1/2 | 116 | 585.00   |
| G-T-3648                | 4,000     | 48 | 36 | 1 1/2 | 66  | 379.00   |
| G-T-3660                | 2,500     | 60 | 36 | 1 1/2 | 83  | 448.00   |
| G-T-3672                | 1,800     | 72 | 36 | 1 1/2 | 97  | 500.00   |
| G-T-3696* ♣             | 4,000     | 96 | 36 | 1 1/2 | 131 | 669.00   |

## STEEL TOPS WITH HARD BOARD



1/8" hardboard helps to deaden sound of items placed or used on work surface and protects durable 12 gauge steel work surface from scratches. Reinforced with 14 gauge mounting brackets. Includes two mounting brackets (enough to mount one workbench drawer or two modular cabinets).

Stringer required for workbenches with legs & no pedestals.

National Motor Freight Class: 70

| CAT. NO.                | LOAD CAP. | W  | D  | H     | WT. | PRICE    |
|-------------------------|-----------|----|----|-------|-----|----------|
| <b>With Stringer</b>    |           |    |    |       |     |          |
| THB-3060                | 2,500     | 60 | 30 | 1 1/2 | 78  | \$549.00 |
| THB-3072                | 1,800     | 72 | 30 | 1 1/2 | 99  | 622.00   |
| THB-3672                | 1,800     | 72 | 36 | 1 1/2 | 119 | 659.00   |
| <b>Without Stringer</b> |           |    |    |       |     |          |
| G-THB-3060              | 2,500     | 60 | 30 | 1 1/2 | 72  | \$505.00 |
| G-THB-3072              | 1,800     | 72 | 30 | 1 1/2 | 92  | 616.00   |
| G-THB-3672              | 1,800     | 72 | 36 | 1 1/2 | 109 | 694.00   |

## HARDWOOD TOPS



\*96" w tops require three legs.  
Features assorted hardwoods in a butcher-block construction to resist warp.

Stringer required for workbenches with legs & no pedestals.

Available in Natural only.

National Motor Freight Class: 70

| CAT. NO.                | LOAD CAP. | W  | D  | H     | WT. | PRICE    |
|-------------------------|-----------|----|----|-------|-----|----------|
| <b>With Stringer</b>    |           |    |    |       |     |          |
| MT-3060 □               | 3,800     | 60 | 30 | 1 3/4 | 95  | \$890.00 |
| MT-3072 □               | 3,600     | 72 | 30 | 1 3/4 | 113 | 1,057.00 |
| MT-3096*                | 4,000     | 96 | 30 | 1 3/4 | 141 | 1,438.00 |
| MT-3660 □               | 3,800     | 60 | 36 | 1 3/4 | 105 | 1,050.00 |
| MT-3672 □               | 3,600     | 72 | 36 | 1 3/4 | 130 | 1,233.00 |
| MT-3696*                | 4,000     | 96 | 36 | 1 3/4 | 169 | 2,153.00 |
| <b>Without Stringer</b> |           |    |    |       |     |          |
| G-MT-3060 □             | 3,800     | 60 | 30 | 1 3/4 | 87  | \$848.00 |
| G-MT-3072 □             | 3,600     | 72 | 30 | 1 3/4 | 103 | 1,008.00 |
| G-MT-3096*              | 4,000     | 96 | 30 | 1 3/4 | 128 | 1,361.00 |
| G-MT-3660 □             | 3,800     | 60 | 36 | 1 3/4 | 97  | 1,008.00 |
| G-MT-3672 □             | 3,600     | 72 | 36 | 1 3/4 | 120 | 1,184.00 |
| G-MT-3696*              | 4,000     | 96 | 36 | 1 3/4 | 156 | 2,076.00 |

### Standard Colors (Unless Otherwise Specified)



♣ □  
Items with these symbols are available to ship in 2-3 days. Limited quantities and select colors.

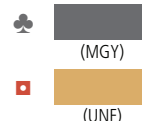

# Workbench Tops

## PLASTIC LAMINATE TOPS

| CAT. NO.                | LOAD CAP. | W  | D  | H     | WT. | PRICE           |
|-------------------------|-----------|----|----|-------|-----|-----------------|
| <b>With Stringer</b>    |           |    |    |       |     |                 |
| PT-3060 ◀               | 800       | 60 | 30 | 1 1/2 | 94  | <b>\$605.00</b> |
| PT-3072 ◀               | 750       | 72 | 30 | 1 1/2 | 110 | <b>713.00</b>   |
| PT-3096*                | 1,200     | 96 | 30 | 1 1/2 | 147 | <b>988.00</b>   |
| PT-3660 ◀               | 800       | 60 | 36 | 1 1/2 | 118 | <b>806.00</b>   |
| PT-3672 ◀               | 750       | 72 | 36 | 1 1/2 | 150 | <b>847.00</b>   |
| PT-3696*                | 1,200     | 96 | 36 | 1 1/2 | 177 | <b>1,141.00</b> |
| <b>Without Stringer</b> |           |    |    |       |     |                 |
| G-PT-3060 ◀             | 800       | 60 | 30 | 1 1/2 | 83  | <b>\$563.00</b> |
| G-PT-3072 ◀             | 750       | 72 | 30 | 1 1/2 | 100 | <b>664.00</b>   |
| G-PT-3096*              | 1,200     | 96 | 30 | 1 1/2 | 134 | <b>911.00</b>   |
| G-PT-3660 ◀             | 800       | 60 | 36 | 1 1/2 | 110 | <b>764.00</b>   |
| G-PT-3672 ◀             | 750       | 72 | 36 | 1 1/2 | 140 | <b>798.00</b>   |
| G-PT-3696*              | 1,200     | 96 | 36 | 1 1/2 | 164 | <b>1,064.00</b> |

Available in White only.



\*96" w tops require three legs.  
High pressure laminate top & edges; particleboard core.  
Non-conductive surface is ideal for electronics.

Stringer required for workbenches with legs & no pedestals.

National Motor Freight Class: 70

## COMPRESSED WOOD TOPS

| CAT. NO.                | LOAD CAP. | W  | D  | H     | WT. | PRICE           |
|-------------------------|-----------|----|----|-------|-----|-----------------|
| <b>With Stringer</b>    |           |    |    |       |     |                 |
| CT-3060 ◻               | 1,900     | 60 | 30 | 1 3/4 | 123 | <b>\$636.00</b> |
| CT-3072 ◻               | 1,500     | 72 | 30 | 1 3/4 | 146 | <b>739.00</b>   |
| CT-3096*                | 2,400     | 96 | 30 | 1 3/4 | 185 | <b>1,184.00</b> |
| CT-3660 ◻               | 1,900     | 60 | 36 | 1 3/4 | 137 | <b>755.00</b>   |
| CT-3672 ◻               | 1,500     | 72 | 36 | 1 3/4 | 174 | <b>881.00</b>   |
| CT-3696*                | 2,400     | 96 | 36 | 1 3/4 | 222 | <b>1,215.00</b> |
| <b>Without Stringer</b> |           |    |    |       |     |                 |
| G-CT-3060 ◻             | 1,900     | 60 | 30 | 1 3/4 | 115 | <b>\$594.00</b> |
| G-CT-3072 ◻             | 1,500     | 72 | 30 | 1 3/4 | 136 | <b>690.00</b>   |
| G-CT-3096*              | 2,400     | 96 | 30 | 1 3/4 | 172 | <b>1,107.00</b> |
| G-CT-3660 ◻             | 1,900     | 60 | 36 | 1 3/4 | 129 | <b>713.00</b>   |
| G-CT-3672 ◻             | 1,500     | 72 | 36 | 1 3/4 | 164 | <b>832.00</b>   |
| G-CT-3696*              | 2,400     | 96 | 36 | 1 3/4 | 209 | <b>1,138.00</b> |

Available in Natural only.

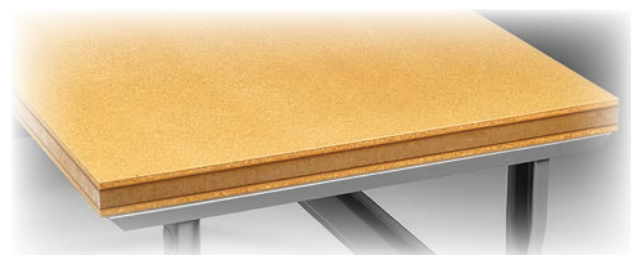

\*96" w tops require three legs.  
Tempered hardboard top and bottom surface laminated to compressed wood core. Banded on all sides with hard maple.

Stringer required for workbenches with legs & no pedestals.

National Motor Freight Class: 70

## STRINGERS

| CAT. NO. | W  | D | H | WT.  | PRICE          |
|----------|----|---|---|------|----------------|
| WBS-48 ♣ | 48 | — | 5 | 6.4  | <b>\$38.00</b> |
| WBS-60 ♣ | 60 | — | 5 | 8.1  | <b>42.00</b>   |
| WBS-72 ♣ | 72 | — | 5 | 9.7  | <b>49.00</b>   |
| WBS-96 ♣ | 96 | — | 5 | 13.2 | <b>77.00</b>   |

Ties workbench legs together for added stability.

Stiffening beads provide added strength.



National Motor Freight Class: 70

## MOUNTING CHANNELS

| CAT. NO.  | W      | D  | H      | WT. | PRICE          |
|-----------|--------|----|--------|-----|----------------|
| WBMC-30 ♣ | 1 3/16 | 30 | 1 5/16 | 4.2 | <b>\$43.00</b> |
| WBMC-36 ♣ | 1 3/16 | 36 | 1 5/16 | 5.0 | <b>52.00</b>   |

Mounts stackable drawer or modular cabinets on steel tops. Two mounting channels are included with steel top; order additional channels for unique configurations only.

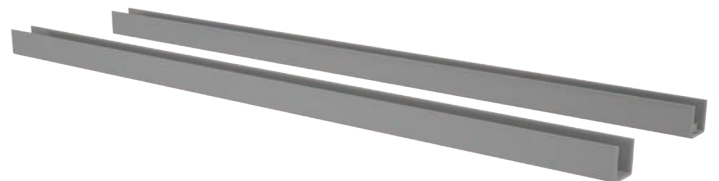

National Motor Freight Class: 70

## MOUNTING ANGLES

| CAT. NO. | W     | D  | H      | WT. | PRICE          |
|----------|-------|----|--------|-----|----------------|
| WBLB-30  | 1 7/8 | 22 | 1 1/16 | 3.4 | <b>\$24.00</b> |

Mounts stackable drawer on electronic workbench. One set required per hanging item.

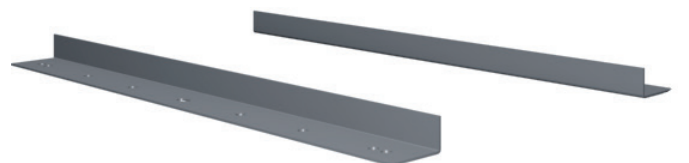

National Motor Freight Class: 70

### Standard Colors (Unless Otherwise Specified)



Items with these symbols are available to ship in 2-3 days. Limited quantities and select colors.



## FLARED LEGS



Priced per leg.  
Complete with two easily removable plastic outlet inserts. Feet prepunched for floor anchoring.

24" deep legs available in quantity; consult factory for pricing.

National Motor Freight Class: 70

| CAT. NO. | LOAD CAP.* | W     | D  | H  | WT.  | PRICE           |
|----------|------------|-------|----|----|------|-----------------|
| L-2830   | 5,000      | 3 1/2 | 30 | 28 | 14.5 | <b>\$105.00</b> |
| L-2836   | 5,000      | 3 1/2 | 36 | 28 | 15.5 | <b>108.00</b>   |
| L-3230♣  | 5,000      | 3 1/2 | 30 | 32 | 14.5 | <b>90.00</b>    |
| L-3236♣  | 5,000      | 3 1/2 | 36 | 32 | 16.0 | <b>95.00</b>    |

\*Load Capacity represents total per pair.

## ADJUSTABLE LEGS



Priced per leg.

Complete with two easily removable plastic outlet inserts. Feet prepunched for floor anchoring.

National Motor Freight Class: 70

| CAT. NO. | LOAD CAP.* | W | D  | H**           | WT.  | PRICE          |
|----------|------------|---|----|---------------|------|----------------|
| AL-3230♣ | 4,000      | 3 | 30 | 27 7/8-35 3/8 | 17.8 | <b>\$97.00</b> |
| AL-3236♣ | 4,000      | 3 | 36 | 27 7/8-35 3/8 | 19.3 | <b>104.00</b>  |
| AL-4230♣ | 3,000      | 3 | 30 | 35 3/8-41 3/8 | 18.8 | <b>118.00</b>  |
| AL-4236♣ | 3,000      | 3 | 36 | 35 3/8-41 3/8 | 20.3 | <b>125.00</b>  |

\*Load Capacity represents total per pair.

\*\*Adjustable on 1 1/2" centers.

## PANEL LEGS



Priced per pair.  
Prepunched holes for easy attachment.

National Motor Freight Class: 70

| CAT. NO. | LOAD CAP.* | W | D  | H  | WT.  | PRICE           |
|----------|------------|---|----|----|------|-----------------|
| LP-3230♣ | 2,000      | 3 | 28 | 32 | 48.0 | <b>\$287.00</b> |

\*Load Capacity represents total per pair.

## CASTER KITS



Swivel

Fixed

Casters attach to 30" or 36" deep Tennsco Flared or adjustable legs to provide mobility for your workbench. Kit includes mounting brackets and four casters, fixed and swivel w/brake. The unit is intended to be pushed only on a clean level surface. It is not to be pulled as injury may result.

National Motor Freight Class: 70

| CAT. NO.                           | LOAD CAP. | DESCRIPTION            | WT. | PRICE           |
|------------------------------------|-----------|------------------------|-----|-----------------|
| <b>For 48"W - 72"W Workbenches</b> |           |                        |     |                 |
| WBCK-3036♣                         | 1,000     | Two fixed, Two swivel  | 16  | <b>\$141.00</b> |
| WBCK-3036S                         | 1,000     | Four swivel            | 16  | <b>147.00</b>   |
| <b>For 96"W Workbenches</b>        |           |                        |     |                 |
| WBCK-3036-3                        | 1,000     | Two fixed, Four swivel | 24  | <b>\$211.00</b> |

NOTE: Lower shelf or two stringers required for stability when using caster kits.

## LOWER SHELVES

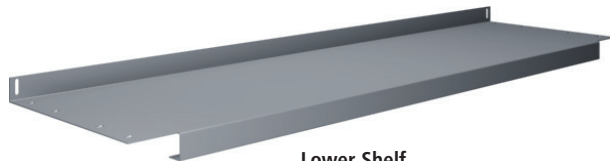

Lower Shelf



Full Depth Lower Shelf

National Motor Freight Class: 70

| CAT. NO.  | LOAD CAP.* | W  | D      | WT.  | PRICE           |
|---|------------|----|--------|------|-----------------|
| <b>Shelf For Flared Leg or Adjustable Leg Workbenches</b>   |            |    |        |      |                 |
| S-48♣   | 450        | 48 | 14     | 15.5 | <b>\$87.00</b>  |
| S-60♣   | 450        | 60 | 14     | 19.5 | <b>102.00</b>   |
| S-72♣   | 350        | 72 | 14     | 23.0 | <b>125.00</b>   |
| S-96♣   | 850        | 96 | 14     | 31.0 | <b>164.00</b>   |
| <b>Full Depth Shelf For Flared Leg Workbenches</b>          |            |    |        |      |                 |
| FS-48   | 450        | 48 | 20     | 21.0 | <b>\$157.00</b> |
| FS-60   | 450        | 60 | 20     | 25.0 | <b>174.00</b>   |
| FS-72   | 350        | 72 | 20     | 30.0 | <b>196.00</b>   |
| FS-96**   | 850        | 96 | 20     | 42.0 | <b>305.00</b>   |
| <b>Full Depth Shelf For 30"D Adjustable Leg Workbenches</b> |            |    |        |      |                 |
| FS-3060   | 450        | 60 | 20 1/2 | 36.0 | <b>\$143.00</b> |
| FS-3072   | 450        | 72 | 20 1/2 | 41.0 | <b>165.00</b>   |
| <b>Full Depth Shelf For 36"D Adjustable Leg Workbenches</b> |            |    |        |      |                 |
| FS-3648   | 450        | 48 | 26 1/2 | 37.0 | <b>\$169.00</b> |
| FS-3660   | 450        | 60 | 26 1/2 | 39.0 | <b>165.00</b>   |
| FS-3672   | 350        | 72 | 26 1/2 | 46.0 | <b>195.00</b>   |
| FS-3696**   | 850        | 96 | 26 1/2 | 60.0 | <b>252.00</b>   |

\*All loads must be evenly distributed.

\*\*96" w are two pieces.

### Standard Colors



Items with this symbol are available to ship in 2-3 days. Limited quantities and select colors.



(MGY)

# Workbench Accessories

**NOTE:** Load capacities for Modular Storage Cabinets and Modular Drawer Cabinets represent units when being used to support a workbench with weight evenly distributed on top. Drawer load capacity is 70 lbs. **Modular Pedestal Cabinets are designed to work with 30" deep workbench tops only.**

## MODULAR CABINETS

| CAT. NO.                                      | LOAD CAP. | W      | D  | H     | WT. | PRICE    |
|---|-----------|--------|----|-------|-----|----------|
| <b>Modular Cabinets</b>                       |           |        |    |       |     |          |
| MS-1524♣                                      | 1,000     | 15     | 24 | 32    | 48  | \$462.00 |
| MD-1524♣                                      | 1,000     | 15     | 24 | 32    | 77  | \$67.00  |
| MD2-1524                                      | 1,000     | 15     | 24 | 32    | 68  | \$911.00 |
| MD3-1524♣                                     | 1,000     | 15     | 24 | 32    | 69  | \$895.00 |
| <b>Caster Kit For Modular Cabinets</b>        |           |        |    |       |     |          |
| CB-1524                                       | 1,000     | 15     | 24 | 3 1/4 | 18  | \$192.00 |
| <b>Extra Drawer Divider (Galvanized Only)</b> |           |        |    |       |     |          |
| WBDD-12♣                                      |           | 12 3/8 | —  | 4 1/4 | 0.6 | \$3.80   |
| <b>Optional Extra Shelf for MS-1524</b>       |           |        |    |       |     |          |
| MBS-1524                                      | 100       | 15     | 23 | 3/4   | 5   | \$63.00  |

Storage Cabinet comes standard with locking recessed handle. One adjustable shelf included. Drawer unit comes standard with keylock which locks all drawers simultaneously. Includes one divider per drawer. The MD-1524 & MD3-1524 come with one plastic pencil tray placed in the top drawer. Order tops without stringers with the modular units.



National Motor Freight Class: Cabinets, 100; Caster Kits, 70

| CAT. NO.  | LOAD CAP. | W  | D  | H  | WT. | PRICE    |
|-----------|-----------|----|----|----|-----|----------|
| WBHC-1516 | 70        | 15 | 18 | 16 | 20  | \$280.00 |

National Motor Freight Class: 100

Cabinet comes standard with locking recessed handle. Can also be mounted under or above stackable drawer.

## HANGING CABINET

Bolt-in center shelf can be flipped so cabinet door can open in either direction.

When mounting to steel top, use one set of Mounting Channels (included with top); when mounting to electronic workbench, use one set of Mounting Angles. Mounts to wood tops directly.



| CAT. NO.                               | LOAD CAP. | W      | D  | H     | WT. | PRICE    |
|--|-----------|--------|----|-------|-----|----------|
| <b>Stackable Drawer</b>                |           |        |    |       |     |          |
| WBD-1-MGY*♣                            | 70        | 15     | 18 | 8 1/4 | 21  | \$147.00 |
| <b>Cam Lock (Field Installable)</b>    |           |        |    |       |     |          |
| CL-1☐                                  |           | —      | —  | —     | 0.1 | \$9.40   |
| <b>Extra Divider (Galvanized Only)</b> |           |        |    |       |     |          |
| WBDD-12☐                               |           | 12 3/8 | —  | 4 1/4 | 0.6 | \$3.80   |

\*Medium Grey Only.

Includes one drawer divider, one removable pencil tray, and installed cam lock with key.

## STACKABLE DRAWERS

When mounting to steel top, use one set of Mounting Channels (included with top); when mounting to electronic workbench, use one set of Mounting Angles. Mounts to wood tops directly.



National Motor Freight Class: 70

| CAT. NO. | LOAD CAP. | W  | D  | H | WT. | PRICE    |
|----------|-----------|----|----|---|-----|----------|
| WBD-25*♣ | 70        | 25 | 22 | 6 | 17  | \$241.00 |

Includes left and right mounting channels, rear brace and drawer. Drawer includes cam lock.

\*Medium Grey Only.

## 25" WIDE HANGING DRAWER

When mounting to steel top, use one set of Mounting Channels (included with top); when mounting to electronic workbench, use one set of Mounting Angles (WBLB-30). Mounts to wood tops directly.



National Motor Freight Class: 70

| CAT. NO. | LOAD CAP. | W  | D  | H     | WT.  | PRICE   |
|----------|-----------|----|----|-------|------|---------|
| SM-42    | 250       | 42 | 14 | 1 1/2 | 14.4 | \$90.00 |

16 gauge steel shelf.

National Motor Freight Class: 70

## MODULAR BENCH LOWER SHELF

For use with workbenches with modular units with 72"W tops.



| CAT. NO. | W  | D  | H | WT.  | PRICE    |
|----------|----|----|---|------|----------|
| SB-3048♣ | 48 | 30 | 3 | 12.2 | \$78.00  |
| SB-3060♣ | 60 | 30 | 3 | 14.0 | \$81.00  |
| SB-3072♣ | 72 | 30 | 3 | 15.7 | \$90.00  |
| SB-3096♣ | 96 | 30 | 3 | 18.9 | \$118.00 |
| SB-3648  | 48 | 36 | 3 | 13.9 | \$85.00  |
| SB-3660  | 60 | 36 | 3 | 15.2 | \$88.00  |
| SB-3672♣ | 72 | 36 | 3 | 17.0 | \$95.00  |
| SB-3696♣ | 96 | 36 | 3 | 19.9 | \$122.00 |

## SIDE & BACK RAIL KITS



Adds 3" to overall workbench height.

National Motor Freight Class: 70

### Standard Colors (Unless Otherwise Specified)



♣ ☐  
Items with these symbols are available to ship in 2-3 days. Limited quantities and select colors.



## WORKBENCH RISER WITH END SUPPORTS



Risers have a 1 1/2" tall backstop. Riser will add 12" overall height to the workbench. May be double stacked.

National Motor Freight Class: 70

| CAT. NO.  | LOAD CAP. | W  | D      | H  | WT.  | PRICE    |
|-----------|-----------|----|--------|----|------|----------|
| R-1048♣   | 600       | 48 | 10 1/2 | 12 | 18.5 | \$139.00 |
| R-1060♣   | 450       | 60 | 10 1/2 | 12 | 21   | 133.00   |
| R-1072♣   | 350       | 72 | 10 1/2 | 12 | 24   | 147.00   |
| R-1096*♣  | 1,000     | 96 | 10 1/2 | 12 | 32   | 230.00   |
| R-106018♣ | 450       | 60 | 10 1/2 | 18 | 24   | 168.00   |
| R-107218♣ | 350       | 72 | 10 1/2 | 18 | 27   | 183.00   |

\*96" w risers use a center upright.

## ELECTRIC RISER WITH END SUPPORTS



Risers have a 1 1/2" tall backstop. Riser will add 12" or 18" overall height to the workbench.

Includes knockouts for four duplex receptacle outlets. Optional wiring kit may be ordered on page 73 or prewired below. May be double stacked.

National Motor Freight Class: 70

| CAT. NO.    | LOAD CAP. | W  | D      | H  | WT. | PRICE    |
|-------------|-----------|----|--------|----|-----|----------|
| RE-1060♣    | 450       | 60 | 10 1/2 | 12 | 27  | \$183.00 |
| RE-1072♣    | 350       | 72 | 10 1/2 | 12 | 31  | 195.00   |
| RE-1560     | 450       | 60 | 15     | 12 | 35  | 234.00   |
| RE-1572     | 350       | 72 | 15     | 12 | 39  | 252.00   |
| RE-18-1560♣ | 450       | 60 | 15     | 18 | 38  | 244.00   |
| RE-18-1572♣ | 350       | 72 | 15     | 18 | 43  | 258.00   |
| RE-18-1596♣ | 300       | 96 | 15     | 18 | 53  | 323.00   |

## PREWIRED ELECTRIC RISER WITH END SUPPORTS



Risers have a 1 1/2" tall backstop. Riser will add 12" or 18" overall height to the workbench. May be double stacked.

National Motor Freight Class: 70

| CAT. NO.          | LOAD CAP. | W  | D      | H  | WT. | PRICE    |
|-------------------|-----------|----|--------|----|-----|----------|
| REI-1060-WK-1     | 450       | 60 | 10 1/2 | 12 | 30  | \$482.00 |
| REI-1072-WK-1     | 350       | 72 | 10 1/2 | 12 | 34  | 498.00   |
| REI-1560-WK-1     | 450       | 60 | 15     | 12 | 35  | 521.00   |
| REI-1572-WK-1     | 350       | 72 | 15     | 12 | 53  | 584.00   |
| REI-18-1560-WK-1♣ | 450       | 60 | 15     | 18 | 54  | 540.00   |
| REI-18-1572-WK-1♣ | 350       | 72 | 15     | 18 | 60  | 564.00   |
| REI-18-1596-WK-1  | 300       | 96 | 15     | 18 | 72  | 640.00   |

## DOUBLE DECKER RISER WITH END SUPPORTS

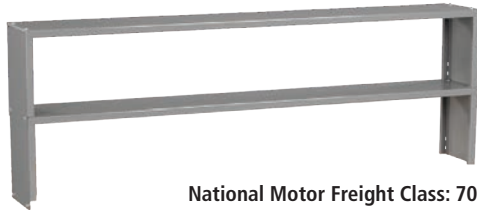

National Motor Freight Class: 70

| CAT. NO. | LOAD CAP. | W  | D      | H  | WT. | PRICE    |
|----------|-----------|----|--------|----|-----|----------|
| R2-1060  | 450       | 60 | 10 1/2 | 24 | 42  | \$277.00 |
| R2-1072  | 350       | 72 | 10 1/2 | 24 | 48  | 301.00   |

Risers have no back flanges. Unit may be mounted in center of top for double entry.

## ELECTRIC OUTLET PANEL FOR BENCHES WITH PANEL LEGS



National Motor Freight Class: 70

| CAT. NO. | W      | D | H     | WT.  | PRICE    |
|----------|--------|---|-------|------|----------|
| WOP-72♣  | 71 5/8 | 3 | 4 3/8 | 17.4 | \$174.00 |

Provides mounting plate for four duplex outlets on 72" panel leg workbenches. Optional wiring kit is available on page 73.

## ELECTRIC OUTLET PANEL FOR BENCHES WITH TWO MODULAR UNITS



National Motor Freight Class: 70

| CAT. NO.                    | W  | D     | H     | WT.  | PRICE    |
|-----------------------------|----|-------|-------|------|----------|
| <b>Without Wiring Kit</b>   |    |       |       |      |          |
| WOP-42♣                     | 42 | 3 3/8 | 4 3/8 | 10.3 | \$95.00  |
| <b>Wiring Kit Installed</b> |    |       |       |      |          |
| WOPI-42-WK-1                | 42 | 3 3/8 | 4 3/8 | 12.8 | \$361.00 |

Provides mounting plate for four duplex outlets on 72" panel leg workbenches. Optional wiring kit is available on page 73.

### Standard Colors (Unless Otherwise Specified)



Items with this symbol are available to ship in 2-3 days. Limited quantities and select colors.



(MGY)

| CAT. NO. | WT. | PRICE    |
|----------|-----|----------|
| WK-1     | 2.5 | \$199.00 |

Prewired for quick installation. Comes complete with four duplex receptacles, on/off switch with pilot light, 8 foot grounded cord and plug, 15 amp, 115 volt service and circuit breaker. Use with electronic riser, outlet panels, or electronic workbench.

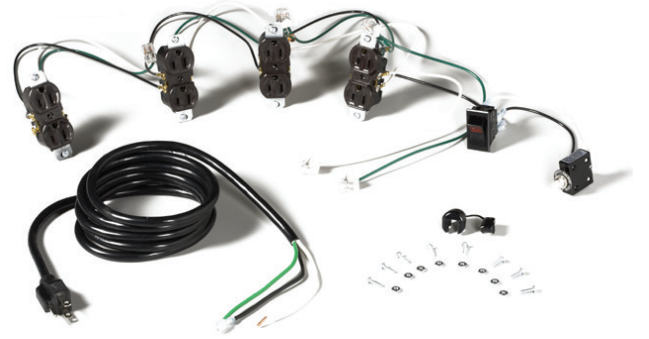

National Motor Freight Class: 70



**SR-57  
OPEN STYLE**



**SR-58  
CLOSED STYLE**



**SR-59  
WALL MOUNTED**

## FOREMAN'S DESKS

| CAT. NO. | W      | D  | H       | LOAD CAPACITY       |        |       | WT. | PRICE      |
|----------|--------|----|---------|---------------------|--------|-------|-----|------------|
|          |        |    |         | TOP                 | DRAWER | SHELF |     |            |
| SR-57    | 34 1/2 | 29 | 53      | Open Style<br>250   | 70     | 200   | 97  | \$885.00   |
| SR-58    | 34 1/2 | 29 | 53      | Closed Style<br>250 | 70     | 200   | 155 | \$1,376.00 |
| SR-59    | 34 1/2 | 29 | 17 1/2* | Wall Mounted<br>250 | 70     | —     | 83  | \$878.00   |

\*Note: If including mounting bracket in height calculations, add 16 1/4" to height listed above. Combines a convenient, sturdy writing surface with compartmentalized riser for storing writing utensils, forms and papers. Drawer comes standard with lock and two keys. Shipped partially assembled.

Medium Grey only. National Motor Freight Class: 70

### Standard Colors



Medium Grey (MGY)

Items with these symbols are available to ship in 2-3 days. Limited quantities and select colors.

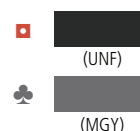

SHOP EQUIPMENT



## CANTILEVERED ACCESSORY SYSTEM

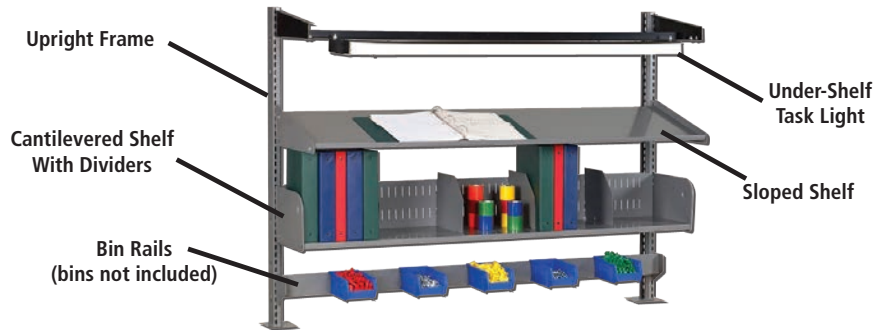

The Cantilevered Accessory System provides a variety of convenient storage options for your workstation. Start with upright frames, then add accessories such as shelves with dividers, sloped shelves, an overhead light, or a bin rail for adding third-party bins for small parts storage.

## UPRIGHT FRAMES



Accessories attach to uprights without tools.

**NOTE: Cantilever system requires 72" or wider top.**

National Motor Freight Class: 70

| CAT. NO. | DESCRIPTION    | W | D     | H  | WT.  | PRICE    |
|----------|----------------|---|-------|----|------|----------|
| WBRU-24A | Sold as a Pair | 4 | 5 1/4 | 24 | 10.7 | \$144.00 |
| WBRU-42A | Sold as a Pair | 4 | 5 1/4 | 42 | 15.7 | \$150.00 |

Upright frames attach to the rear edge of the work surface to provide a substantial structure from which to support storage shelves, bin rails, sloped shelves and lighting. Attaches with four bolts per side (drilling required to attach). Both sizes of uprights may be attached directly to the Tensco steel or wood tops.

## CANTILEVERED SHELF

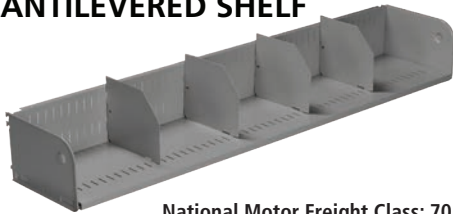

National Motor Freight Class: 70

| CAT. NO.   | W  | D  | H     | WT. | PRICE    |
|------------|----|----|-------|-----|----------|
| TWBS-6012A | 60 | 12 | 7 1/2 | 21  | \$151.00 |

May be quickly and easily repositioned. Four adjustable dividers are furnished with each shelf.

## SLOPED SHELF

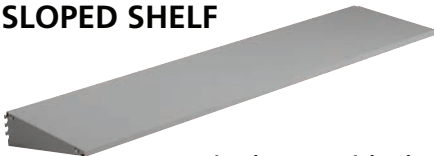

National Motor Freight Class: 70

| CAT. NO.   | W  | D  | H   | WT. | PRICE   |
|------------|----|----|-----|-----|---------|
| TWSS-6012A | 60 | 12 | 3/4 | 19  | \$90.00 |

May be quickly and easily repositioned. Includes a front lip to keep items from rolling off the shelf.

## BIN RAIL

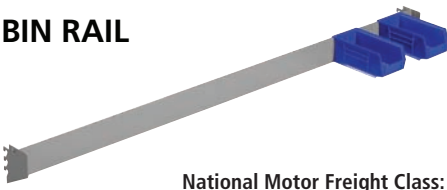

National Motor Freight Class: 70

| CAT. NO. | W  | D     | H      | WT. | PRICE    |
|----------|----|-------|--------|-----|----------|
| TWBR-60  | 60 | 3 7/8 | 4 3/16 | 7   | \$164.00 |

Bin Rails accommodate a variety of commercially available plastic and steel parts bins. Easily adjustable up or down on the upright frame. Bins not included.

## CANTILEVER TASK LIGHTING



National Motor Freight Class: 70

| CAT. NO. | W       | D      | H       | WT. | PRICE    |
|----------|---------|--------|---------|-----|----------|
| TWCTL-48 | 50 5/32 | 8      | 1 25/32 | 14  | \$322.00 |
| TWLB-60  | 60      | 13 1/2 | 3 1/2   | 8.2 | \$78.00  |

The cantilever task light provides overhead lighting for your work area. Unit contains two 32-watt lamps and is prewired with an 8' power cord and power switch. Use bracket kit for mounting onto cantilever uprights. Mounting bracket allows light to adjust back and forth in 1 1/2" increments, or an angle if mounted on top. Available in black only.

Standard Colors (Unless Otherwise Specified)



SHOP EQUIPMENT

# Mobile Workbenches & Service Carts

## MOBILE WORKBENCHES



MB-1-2542



MB-2530-BB



MB-3-2545



MB-4-2545



MB-2-2542



MB-2530-C



MB-5-2545



MB-6-2545



MB-7-2545



REI-1045-WK-1



MHE-25

| CAT. NO.   | LOAD CAP. | W  | D  | H      | WT.  | PRICE      |
|--|-----------|----|----|--------|------|------------|
| <b>Mobile Workbenches</b>  |           |    |    |        |      |            |
| *MB-1-2542♣  | 1,000     | 42 | 25 | 36 1/4 | 182  | \$1,946.00 |
| *MB-2-2542♣  | 1,000     | 42 | 25 | 36 1/4 | 157  | 1,588.00   |
| **MB-2530-BB♣  | 1,000     | 33 | 25 | 40     | 234  | 2,036.00   |
| **MB-2530-C♣   | 1,000     | 33 | 25 | 40     | 153  | 1,338.00   |
| **MB-3-2545♣   | 1,000     | 48 | 25 | 40     | 294  | 2,843.00   |
| **MB-4-2545♣   | 1,000     | 48 | 25 | 40     | 270  | 2,439.00   |
| **MB-5-2545  | 1,000     | 48 | 25 | 40     | 220  | 2,286.00   |
| **MB-6-2545  | 1,000     | 48 | 25 | 40     | 251  | 2,215.00   |
| **MB-7-2545  | 1,000     | 48 | 25 | 40     | 278  | 2,523.00   |
| <b>Extra Shelf For Cabinet of MB-1-2542 or MB-2-2542</b>                       |           |    |    |        |      |            |
| MBS-2124   | 100       | 21 | 23 | 3/4    | 6.4  | \$73.00    |
| <b>Extra Shelf For Left Side of MB-2-2542 or 15" Wide Single Door Cabinets</b> |           |    |    |        |      |            |
| MBS-1524   | 100       | 15 | 23 | 3/4    | 5.0  | \$63.00    |
| <b>Prewired Electric Riser (Fits only 48" wide units)</b>                      |           |    |    |        |      |            |
| REI-1045-WK-1  | —         | 45 | 8  | 10 1/4 | 23.0 | \$386.00   |
| <b>Electric Riser (Fits only 48" wide units)</b>                               |           |    |    |        |      |            |
| RE-1045*   | —         | 45 | 8  | 10 1/4 | 23.0 | \$186.00   |
| <b>Push Handle Power Strip</b>   |           |    |    |        |      |            |
| MHE-25   | —         | 25 | 8  | 10 1/4 | 5.0  | \$290.00   |

\*Side and Back Rail adds 1 3/4" to overall workbench height.

\*\*Side and Back Rail on the 3" to overall workbench height.

\*Optional wiring kit (WK-1) may be ordered on page 73.

National Motor Freight Class: 100

| CAT. NO.  | LOAD CAP. | W  | D  | H     | WT.  | PRICE    |
|---|-----------|----|----|-------|------|----------|
| <b>16" Wide Service Cart</b>                          |           |    |    |       |      |          |
| SC-1630♣  | 150*      | 30 | 16 | 32    | 36   | \$319.00 |
| <b>Optional Center Tray For 16" Wide Service Cart</b> |           |    |    |       |      |          |
| ST-16♣  | 150       | 30 | 16 | 3 1/4 | 11   | \$91.00  |
| <b>24" Wide Service Cart</b>                          |           |    |    |       |      |          |
| SC-2436♣  | 150*      | 36 | 24 | 32    | 40   | \$385.00 |
| <b>Optional Center Tray For 24" Wide Service Cart</b> |           |    |    |       |      |          |
| ST-24♣  | 150       | 36 | 24 | 3 1/4 | 15.8 | \$120.00 |

\*Load capacity is 150 lbs. per tray.

Two-shelf service cart with optional center tray. Trays have 3/8" lip and can be reversed to use as either a flat work surface or a storage compartment. Hard rubber casters (two swivel and two stationary). Shipped unassembled.

National Motor Freight Class: 70

### Standard Colors (Unless Otherwise Specified)



♣ Items with these symbols are available to ship in 2-3 days. Limited quantities and select colors.



## SERVICE CARTS

Available in Medium Grey only.



SHOP EQUIPMENT

## PACKING TABLES

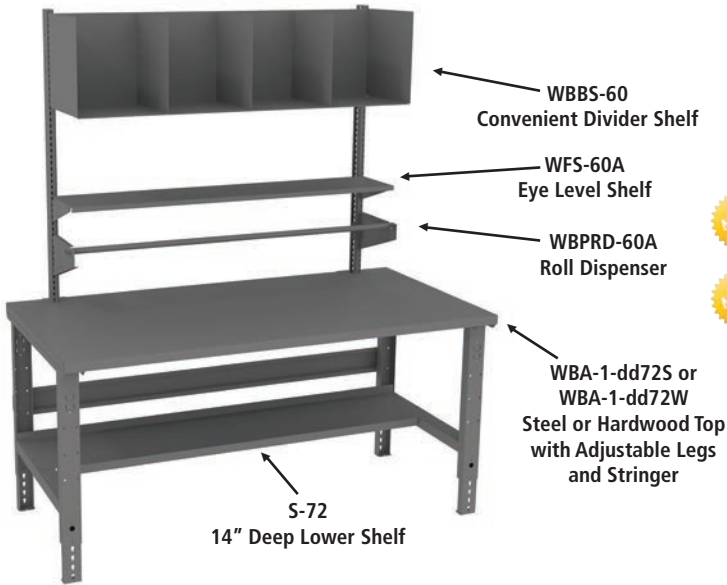

| CAT. NO.                               | W  | D  | H       | WT. | PRICE             |
|--|----|----|---------|-----|-------------------|
| <b>Packing Table with Steel Top</b>    |    |    |         |     |                   |
| <b>NEW</b> APT-3072S                   | 72 | 30 | 83 7/16 | 252 | <b>\$1,858.00</b> |
| APT-3672S                              | 72 | 36 | 83 7/16 | 271 | <b>1,936.00</b>   |
| <b>Packing Table with Hardwood Top</b> |    |    |         |     |                   |
| <b>NEW</b> APT-3072W                   | 72 | 30 | 83 7/16 | 275 | <b>\$2,456.00</b> |
| APT-3672W                              | 72 | 36 | 83 7/16 | 295 | <b>2,634.00</b>   |

Available in Medium Grey only.

- Assembly required.

National Motor Freight Class: 70

## PACKING TABLE ACCESSORIES

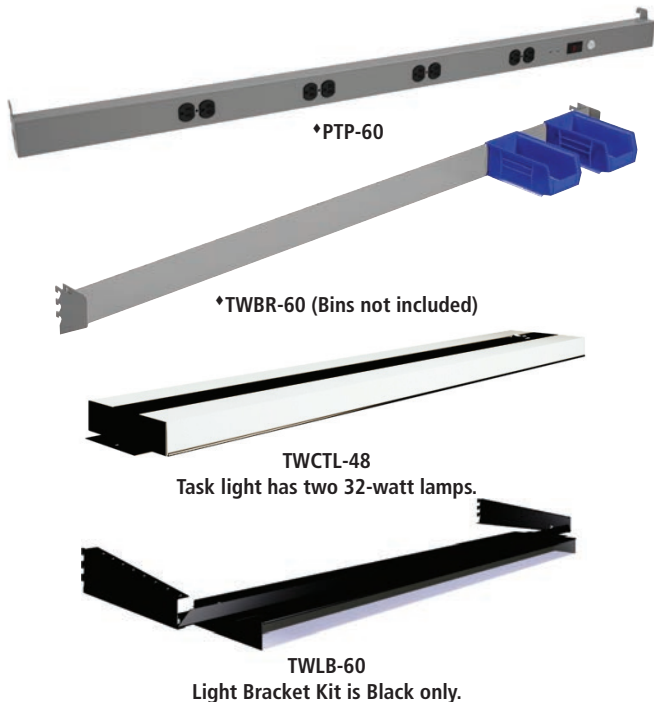

| CAT. NO.                       | W       | D      | H       | WT. | PRICE           |
|--------------------------------|---------|--------|---------|-----|-----------------|
| <b>Power Rail</b>              |         |        |         |     |                 |
| PTP-60*                        | 57 3/32 | 2 1/2  | 1 3/4   | 12  | <b>\$454.00</b> |
| <b>Bin Rail</b>                |         |        |         |     |                 |
| TWBR-60*                       | 57 7/32 | 3 7/8  | 4 3/16  | 7   | <b>\$164.00</b> |
| <b>Task Light</b>              |         |        |         |     |                 |
| TWCTL-48                       | 50 5/32 | 8      | 1 25/32 | 14  | <b>\$322.00</b> |
| <b>Task Light Bracket Kit*</b> |         |        |         |     |                 |
| TWLB-60                        | 60      | 13 1/2 | 3 1/2   | 8.2 | <b>\$78.00</b>  |

\*Task Light Bracket Kit required for Task Light.

\*Optional wiring kit (WK-1) may be ordered on page 73.

\*Available in Medium Grey only.

National Motor Freight Class: 70

### Standard Colors (Unless Otherwise Specified)





































SHOP EQUIPMENT





**PRODUCT LINE OVERVIEW**

|                         |   |   |   |  |   |   |   |   |   |   |
|-------------------------|---|---|---|--|---|---|---|---|---|---|
| <b>STORAGE CABINETS</b> |    |    |    |     |      |   |   |   |   |   |
|                         | Deluxe  | Standard  | Jumbo   | C-Thru   | Specialty   |   |   |   |   |   |
| <b>BOOKCASES</b>        |    |    |    |  |   |   |   |   |   |   |
|                         | 13 1/2" Deep  | 18" Deep  | Cabinet/Bookcase Combo  |  |   |   |   |   |   |   |
| <b>FILING</b>           |   |   |   |    |    |   |   |   |   |   |
|                         | Card & Multimedia   | Fixed Shelf Lateral File  | Lateral File  | Imperial Shelving  | Lit. Sorter & 30 Drawers  |   |   |   |   |   |
| <b>LOCKERS</b>          |  |  |  |   |    |   |   |   |   |   |
|                         | Standard  | Ventilated  | C-Thru  | Heavy-Duty   | Cubby   |   |   |   |   |   |
| <b>SHELVING</b>         |  |  |  |   |    |    |   |  |  |  |
|                         | Bulk Rack   | ESP   | Q-Line  | Stur-D-Stor  | Regal   | Z-Line  | Record Archive  | Capstone  | L&T   | Estey Library   |
| <b>SHOP EQUIPMENT</b>   |  |  |  |  |  |  |  |   |   |   |
|                         | All Purpose Workbench   | Electronic Workbench  | Modular Workbench   | Modular/Mobile Tool Cart   | Foreman's Desk  | Service Cart  | Packing Table   |   |   |   |



Customer Service: (866) 446-8686 • [www.tennsco.com](http://www.tennsco.com) • [customerservice@tennsco.com](mailto:customerservice@tennsco.com)



**PROUDLY MADE IN THE U.S.A.**